



Bryant Development and Review Committee Meeting

Boswell Municipal Complex - City Hall Conference Room

210 SW 3rd Street

Date: January 18, 2024 - **Time:** 9:00 AM

Call to Order

Old Business

New Business

1. Lot 31 & 32 Replat - Pikewood Subdivision - 2903 Pikewood Dr

Veer Investment Properties - Requesting Recommendation for Approval of Replat

- [0827-PLT-01.pdf](#)
- [0827-RPLT-01.pdf](#)

2. 3903 Pikewood Dr - Lot 31A - Conditional Use Permit

Veer Investment Properties - Requesting Recommendation for Approval of CUP for Duplex

- [0828-APP-01.pdf](#)

3. 3903 Pikewood Dr - Lot 31B - Conditional Use Permit

Veer Investment Properties - Requesting Recommendation for Approval of CUP for Duplex

- [0829-APP-01.pdf](#)

4. Casa De Campo - Lot 23 - Ward Dr - Conditional Use Permit

Hester Home Solutions - Requesting Recommendation for Approval of CUP for Duplex

- [0831-APP-01.pdf](#)

5. Casa De Campo - Lot 21 - Ward Dr - Conditional Use Permit

Sean Laisure Construction - Requesting Recommendation for Approval of CUP for Duplex

- [0832-APP-01.pdf](#)

6. Kensington Place Ph. 3 - Final Plat

GarNat Engineering - Requesting Recommendation for Approval of Final Plat

- [0825-ASB-01.pdf](#)
- [0825-PLT-01.pdf](#)
- [0825-BOA-01.pdf](#)
- [0825-APP-01.pdf](#)
- [0825-LTR-02.pdf](#)
- [0825-LTR-01.pdf](#)

7. Summerwood Sports Complex Gym 3 - Revised Plans - Hwy 5 and Bryant Parkway

Phillip Lewis Engineering - Requesting Approval for Revised Site Plan

- [0824-CMT-01.pdf](#)
- [0824-PLN-02.pdf](#)
- [0824-ITR-01.pdf](#)
- [0824-ELV-01.pdf](#)
- [0824-DRN-01.pdf](#)
- [0824-PLN-01.pdf](#)

8. ACA - Storm Shelter - 21815 I-30

Perry Black - Requesting Site Plan Approval for New Storm Shelter

- [0826-PLN-01.pdf](#)

Staff Approved

9. Sharks - 5309 HWY 5 - Sign Permit

Aero Signs - Requesting Sign Permit Approval - STAFF APPROVED

- [0822-APP-02.jpg](#)

Permit Report

Adjournments



INTERSTATE HWY NO 30

LITTLE ROCK

ON

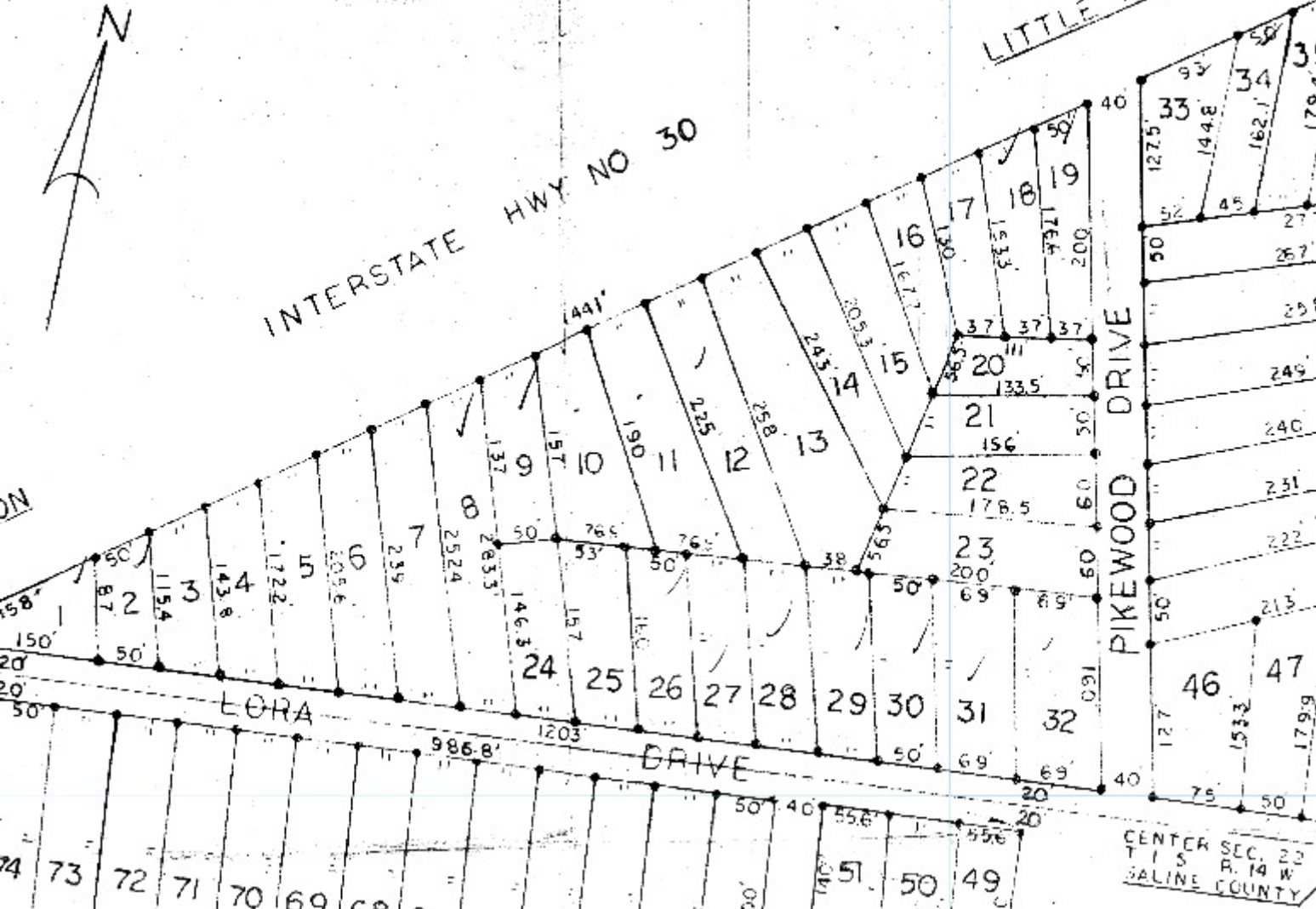

CENTER SEC. 22
T. 15 S. R. 14 W
SALINE COUNTY

LOTS 31A 31B AND 32A
BEING A REPLAT OF LOTS 31 AND 32
PIKEWOOD SUBDIVISION

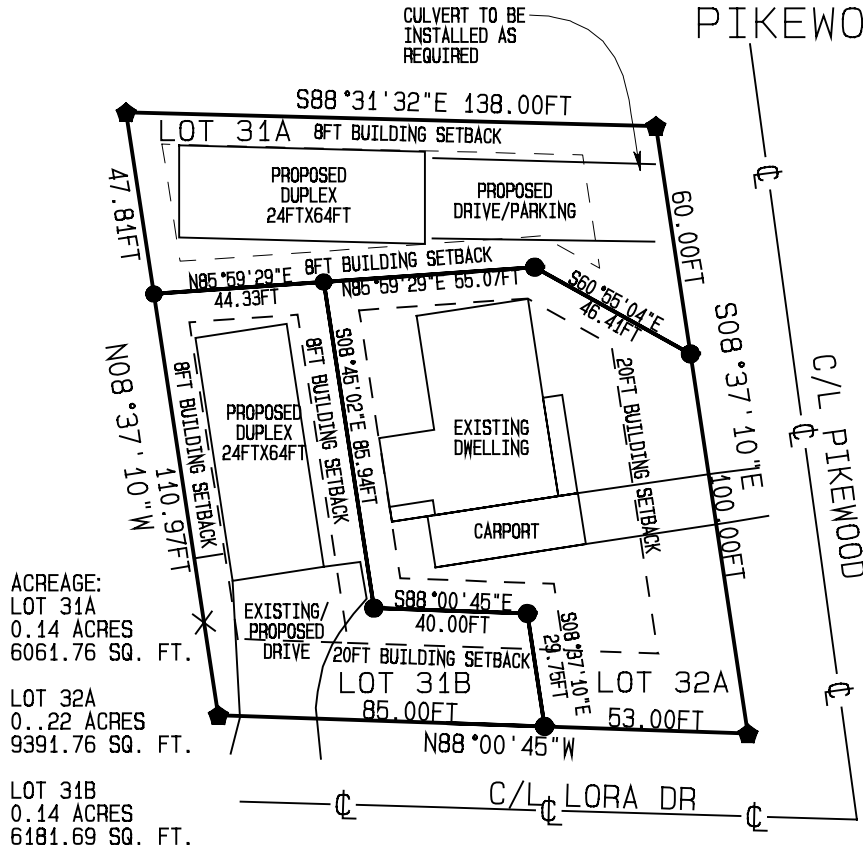

ACREAGE:
LOT 31A
0.14 ACRES
6061.76 SQ. FT.

LOT 32A
0.22 ACRES
9391.76 SQ. FT.

LOT 31B
0.14 ACRES
6181.69 SQ. FT.

I hereby certify that the hereon plat and described survey was completed under my supervision to the best of my professional knowledge and ability.

Brian J. Watson
BRIAN J. WATSON
P.L.S. #1864

No investigation or other search was performed for easements or other records that an accurate and current title search may disclose

SOURCE OF TITLE
SALINE COUNTY DOCUMENT#
2023/007396

DATE: 3 JAN. 2024

JOB#23-64

SCALE: 1IN.=50FT.

DRAWN BY: BW

LEGAL DESCRIPTION:

All that part of Lots 31 and 32, Pikewood Subdivision to Saline County, Arkansas, more particularly described as follows: Beginning at the Northeast corner of said Lot 32, thence South 08 deg. 37 min. 10 sec. East a distance of 160.00 feet to the Southeast corner of said Lot 32; thence North 88 deg. 00 min. 45 sec. West a distance of 138.00 feet to the Southwest corner of said Lot 31; thence North 08 deg. 37 min. 10 sec. West a distance of 158.78 feet to the Northwest corner of said Lot 31; thence South 88 deg. 31 min. 32 sec. East a distance of 138.00 feet to the Point of Beginning, containing 0.50 acres, more or less

CERTIFICATE OF FINAL PLAT APPROVAL

Pursuant to the City of Bryant Subdivision Rules and Regulations, this Document was given approval by the Bryant Planning Commission at a meeting held _____, 2024. All of the Document is hereby accepted, and this certificate executed under the authority of said Rules and Regulations

Bryant Planning Commission

Date of Execution

CERTIFICATE OF OWNER

We, the undersigned, owners of the Real Estate, shown and described herein, do hereby certify that we caused to be laid off, platted, and subdivided, and do hereby layoff, plat, and subdivide said Real Estate in accordance with the Plat

Date of Execution

President: Maunish Shah
Owner/Developer:
Veer Investment Properties LLC
12 Longwell Loop
Little Rock AR 72211

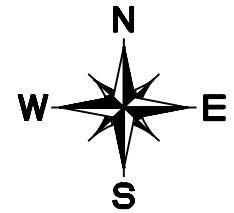

BEARINGS BASED ON GRID
NORTH BY GPS OBSERVATION
SCALE 1"=50'

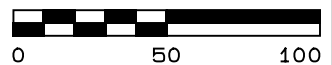

FOR THE USE AND BENEFIT OF
VEER INVESTMENT PROPERTIES LLC

Symbol	Description
▲	COMPUTED
◆	REBAR
●	SET REBAR
—C—	CENTER LINE
—X—	FENCE (X) LINE
—	PROPERTY LINE

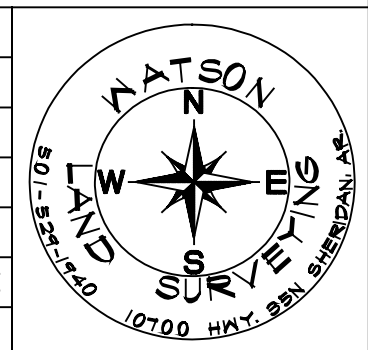



City of Bryant, Arkansas
Community Development
210 SW 3rd Street Bryant, AR 72022
501-943-0943

Conditional Use Permit Application

Applicants are advised to read the Conditional Use Permit section of Bryant Zoning Code prior to completing and signing this form. The Zoning Code is available at www.cityofbryant.com under the Planning and Community Development tab.

Date: 1/8/2024

Applicant or Designee:

Name VEER investment Properties LLC

Address 12 Longwell Loop, LR, AR 72211

Phone 501 766 9090

Email Address: veersuite@gmail.com

Project Location:

Property Address 2903 Pikewood Dr, Lot 31A

Bryant, AR 72022

Parcel Number _____

Zoning Classification R-M

Property Owner (If different from Applicant):

Name _____

Phone _____

Address _____

Email Address _____

Additional Information:

Legal Description (Attach description if necessary)

Pikewood Subdivision lots 31+32

Description of Conditional Use Request (Attach any necessary drawings or images)

Proposed/Current Use of Property Duplexes, current use Single Family Home

Application Checklist

Requirements for Submission

- Letter stating request of Conditional Use and reasoning for request
- Completed Conditional Use Permit Application
- Submit Conditional Use Permit Application Fee (\$125)
- Submit Copy of completed Public Notice
- Publication: Public Notice shall be published at least one (1) time fifteen (15) days prior to the public hearing at which the variance will be heard. Once published please provide a proof of publication to the Community Development office.
- Posting of Property: The city shall provide a sign to post on the property involved for the fifteen (15) consecutive days leading up to Public hearing. One (1) sign is required for every two hundred (200) feet of street frontage.
- Submit eight (8) Copies of the Development Plan (Site Plan) showing:
 - Location, size, and use of buildings/signs/land or improvements
 - Location, size, and arrangement of driveways and parking. Ingress/Egress
 - Existing topography and proposed grading
 - Proposed and existing lighting
 - Proposed landscaping and screening
 - Use of adjacent properties
 - Scale, North Arrow, Vicinity Map
 - Additional information that may be requested by the administrative official due to unique conditions of the site.

Once the application is received, the material will be reviewed to make sure all the required information is provided. The applicant will be notified if additional information is required. The application will then go before the Development and Review Committee (DRC) for a recommendation to the Planning Commission. A public hearing will be held at this meeting for comments on the Conditional Use. After the public hearing, the Planning Commission will make a decision on the use.

Note: that this is not an exhaustive guideline regarding the Conditional Use Permit Process. Additional information is available in the Bryant Zoning Ordinance.

READ CAREFULLY BEFORE SIGNING

I _____, do hereby certify that all information contained within this application is true and correct. I further certify that the owner of the property authorizes this proposed application. I understand that I must comply with all City Codes and that it is my responsibility to obtain all necessary permits required.

NOTICE OF PUBLIC HEARING

A public hearing will be held on Monday, February 12th, 2024 at 6:00 P.M.
at the Bryant City Office Complex, 210 Southwest 3rd Street, City of Bryant, Saline
County, for the purpose of public comment on a conditional use request at the site of
2903 Pikewood Dr, Lot 31A + Lot 31B (address).

A legal description of this property can be obtained by contacting the Bryant Department
of Community Development.

-Rick Johnson
-Chairman Board of Zoning Adjustment
City of Bryant

*This notice is to be run in the legal notices section of the Saline Courier
no less than 15 days prior to the public hearing.*



City of Bryant, Arkansas
Community Development
210 SW 3rd Street Bryant, AR 72022
501-943-0943

Conditional Use Permit Application

Applicants are advised to read the Conditional Use Permit section of Bryant Zoning Code prior to completing and signing this form. The Zoning Code is available at www.cityofbryant.com under the Planning and Community Development tab.

Date: 1/8/2024

Applicant or Designee:

Name VEER investment Properties LLC
Address 12 Longwell Loop, LR AR 72211
Phone 501 766 9090
Email Address: veersuite@gmail.com

Project Location:

Property Address 2903 Pikewood, Lot 31B
Bryant, AR 72022
Parcel Number _____
Zoning Classification R-M

Property Owner (If different from Applicant):

Name _____
Phone _____
Address _____
Email Address _____

Additional Information:

Legal Description (Attach description if necessary)

Pikewood Subdivision lots 31+32

Description of Conditional Use Request (Attach any necessary drawings or images)

Proposed/Current Use of Property Duplexes, current use Single Family Home

DRC
Jan. 18th
Brian OR
Heather

Application Checklist

Requirements for Submission

- Letter stating request of Conditional Use and reasoning for request
- Completed Conditional Use Permit Application
- Submit Conditional Use Permit Application Fee (\$125)
- Submit Copy of completed Public Notice
- Publication: Public Notice shall be published at least one (1) time fifteen (15) days prior to the public hearing at which the variance will be heard. Once published please provide a proof of publication to the Community Development office.
- Posting of Property: The city shall provide a sign to post on the property involved for the fifteen (15) consecutive days leading up to Public hearing. One (1) sign is required for every two hundred (200) feet of street frontage.
- Submit eight (8) Copies of the Development Plan (Site Plan) showing:
 - Location, size, and use of buildings/signs/land or improvements
 - Location, size, and arrangement of driveways and parking. Ingress/Egress
 - Existing topography and proposed grading
 - Proposed and existing lighting
 - Proposed landscaping and screening
 - Use of adjacent properties
 - Scale, North Arrow, Vicinity Map
 - Additional information that may be requested by the administrative official due to unique conditions of the site.

Feb 12th
Planning Com
meeting

Sellin
Courier
18th to 28th
Run 1 times

→ email publication to Colton

Once the application is received, the material will be reviewed to make sure all the required information is provided. The applicant will be notified if additional information is required. The application will then go before the Development and Review Committee (DRC) for a recommendation to the Planning Commission. A public hearing will be held at this meeting for comments on the Conditional Use. After the public hearing, the Planning Commission will make a decision on the use.

Note: that this is not an exhaustive guideline regarding the Conditional Use Permit Process. Additional information is available in the Bryant Zoning Ordinance.

READ CAREFULLY BEFORE SIGNING

I _____, do hereby certify that all information contained within this application is true and correct. I further certify that the owner of the property authorizes this proposed application. I understand that I must comply with all City Codes and that it is my responsibility to obtain all necessary permits required.

NOTICE OF PUBLIC HEARING

A public hearing will be held on Monday, February 12th, 2024 at 6:00 P.M.
at the Bryant City Office Complex, 210 Southwest 3rd Street, City of Bryant, Saline
County, for the purpose of public comment on a conditional use request at the site of
2903 Pikewood Dr, Lot 31A + Lot 31B (address).

A legal description of this property can be obtained by contacting the Bryant Department
of Community Development.

-Rick Johnson
-Chairman Board of Zoning Adjustment
City of Bryant

*This notice is to be run in the legal notices section of the Saline Courier
no less than 15 days prior to the public hearing.*



City of Bryant, Arkansas
Community Development
210 SW 3rd Street Bryant, AR 72022
501-943-0943

Conditional Use Permit Application

Applicants are advised to read the Conditional Use Permit section of Bryant Zoning Code prior to completing and signing this form. The Zoning Code is available at www.cityofbryant.com under the Planning and Community Development tab.

Date: 1/10/24

Applicant or Designee:

Name Joshua Hester
Hester Home Solutions

Address 7513 Hunt Rd, Benton, AR 72019

Phone 501-912-8667

Email Address: Jashhester28@gmail.com

Project Location:

Property Address Ward Dr, Bryant, AR 72022

Parcel Number 840-03588-065

Zoning Classification _____

Property Owner (If different from Applicant):

Name Nathan Brady

Phone 501-672-1557

Address 10432 Beed Rd, Alexander, AR 72002

Email Address nbrady71@gmail.com

Additional Information:

Legal Description (Attach description if necessary)

Casa De Campo, Lot 23

Description of Conditional Use Request (Attach any necessary drawings or images)

Duplex

Proposed/Current Use of Property Duplex / currently undeveloped

Application Checklist

Requirements for Submission

- Letter stating request of Conditional Use and reasoning for request
- Completed Conditional Use Permit Application
- Submit Conditional Use Permit Application Fee (\$125)
- Submit Copy of completed Public Notice
- Publication: Public Notice shall be published at least one (1) time fifteen (15) days prior to the public hearing at which the variance will be heard. Once published please provide a proof of publication to the Community Development office.
- Posting of Property: The city shall provide a sign to post on the property involved for the fifteen (15) consecutive days leading up to Public hearing. One (1) sign is required for every two hundred (200) feet of street frontage.
- Submit eight (8) Copies of the Development Plan (Site Plan) showing:
 - Location, size, and use of buildings/signs/land or improvements
 - Location, size, and arrangement of driveways and parking. Ingress/Egress
 - Existing topography and proposed grading
 - Proposed and existing lighting
 - Proposed landscaping and screening
 - Use of adjacent properties
 - Scale, North Arrow, Vicinity Map
 - Additional information that may be requested by the administrative official due to unique conditions of the site.

Once the application is received, the material will be reviewed to make sure all the required information is provided. The applicant will be notified if additional information is required. The application will then go before the Development and Review Committee (DRC) for a recommendation to the Planning Commission. A public hearing will be held at this meeting for comments on the Conditional Use. After the public hearing, the Planning Commission will make a decision on the use.

Note: that this is not an exhaustive guideline regarding the Conditional Use Permit Process. Additional information is available in the Bryant Zoning Ordinance.

READ CAREFULLY BEFORE SIGNING

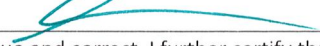
I  do hereby certify that all information contained within this application is true and correct. I further certify that the owner of the property authorizes this proposed application. I understand that I must comply with all City Codes and that it is my responsibility to obtain all necessary permits required.

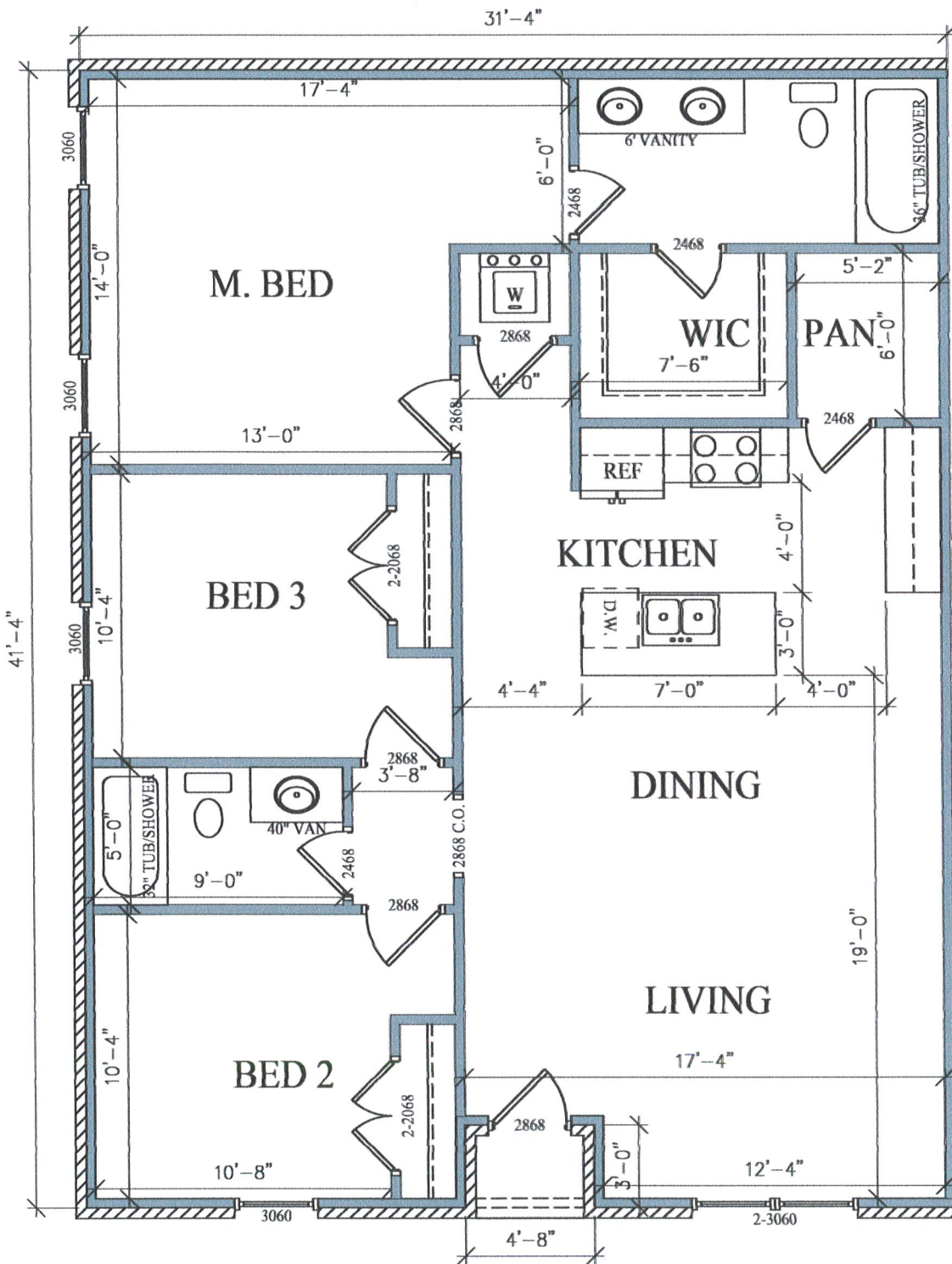

 BY: MW
 New Construction & Remodel

01/04/2024

M24-002 SEAN LAISURE OPT B
1324 SQ FT HEAT/COOL BRICK:



City of Bryant, Arkansas
Community Development
210 SW 3rd Street Bryant, AR 72022
501-943-0943

Conditional Use Permit Application

Applicants are advised to read the Conditional Use Permit section of Bryant Zoning Code prior to completing and signing this form. The Zoning Code is available at www.cityofbryant.com under the Planning and Community Development tab.

Date: 1-10-24

Applicant or Designee:

Jeffrey Sean Laisure
Name Sean Laisure Construction LLC

Address 1131 Brookhaven Ct. Alexander 72002

Phone 501-831-7336

Email Address: SeanLaisure@gmail.com

Project Location:

Property Address Ward Dr. Bryant AR. 72022

Parcel Number 840-05588-063

Zoning Classification _____

Property Owner (If different from Applicant):

Name Nathan Brady

Phone 501-672-1557

Address 10482 Reed Rd. Alexander AR 72002

Email Address gnbrady71@gmail.com

Additional Information:

Legal Description (Attach description if necessary)

Casa De Campo, 21

Description of Conditional Use Request (Attach any necessary drawings or images)

Duplex

Proposed/Current Use of Property Duplex / currently undeveloped

Application Checklist

Requirements for Submission

- Letter stating request of Conditional Use and reasoning for request
- Completed Conditional Use Permit Application
- Submit Conditional Use Permit Application Fee (\$125)
- Submit Copy of completed Public Notice
- Publication: Public Notice shall be published at least one (1) time fifteen (15) days prior to the public hearing at which the variance will be heard. Once published please provide a proof of publication to the Community Development office.
- Posting of Property: The city shall provide a sign to post on the property involved for the fifteen (15) consecutive days leading up to Public hearing. One (1) sign is required for every two hundred (200) feet of street frontage.
- Submit eight (8) Copies of the Development Plan (Site Plan) showing:
 - Location, size, and use of buildings/signs/land or improvements
 - Location, size, and arrangement of driveways and parking. Ingress/Egress
 - Existing topography and proposed grading
 - Proposed and existing lighting
 - Proposed landscaping and screening
 - Use of adjacent properties
 - Scale, North Arrow, Vicinity Map
 - Additional information that may be requested by the administrative official due to unique conditions of the site.

Once the application is received, the material will be reviewed to make sure all the required information is provided. The applicant will be notified if additional information is required. The application will then go before the Development and Review Committee (DRC) for a recommendation to the Planning Commission. A public hearing will be held at this meeting for comments on the Conditional Use. After the public hearing, the Planning Commission will make a decision on the use.

Note: that this is not an exhaustive guideline regarding the Conditional Use Permit Process. Additional information is available in the Bryant Zoning Ordinance.

READ CAREFULLY BEFORE SIGNING

I  do hereby certify that all information contained within this application is true and correct. I further certify that the owner of the property authorizes this proposed application. I understand that I must comply with all City Codes and that it is my responsibility to obtain all necessary permits required.

KENSINGTON PLACE SUBDIVISION PHASE 3 BRYANT, ARKANSAS

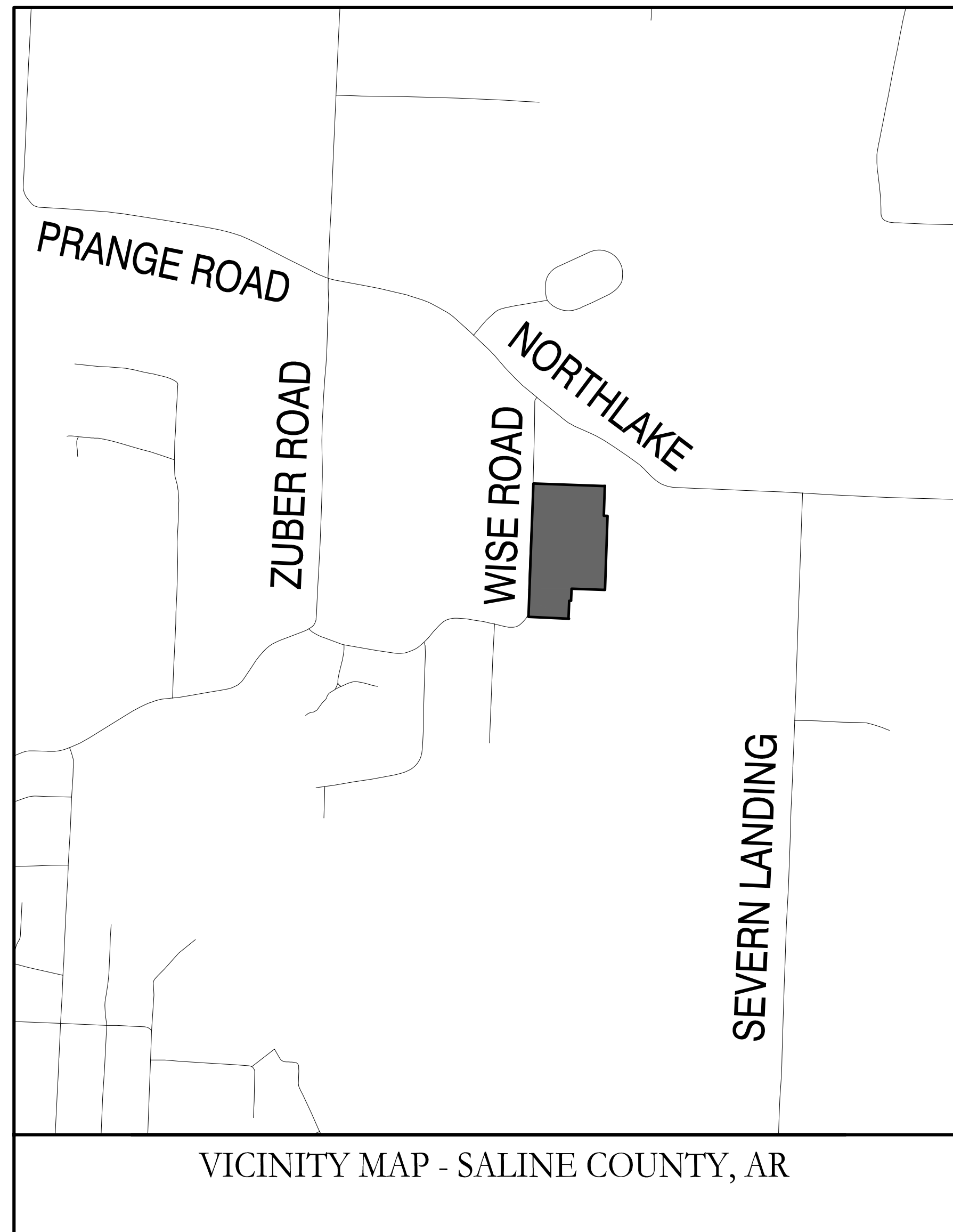

Prepared by:
GarNat Engineering, LLC
Designing our client's success
www.garnatengineering.com

P.O. Box 116
Benton, AR 72018
Ph (501) 408-4650

3825 Mt Carmel Road
Bryant, AR 72022
Fx (888) 900-3068

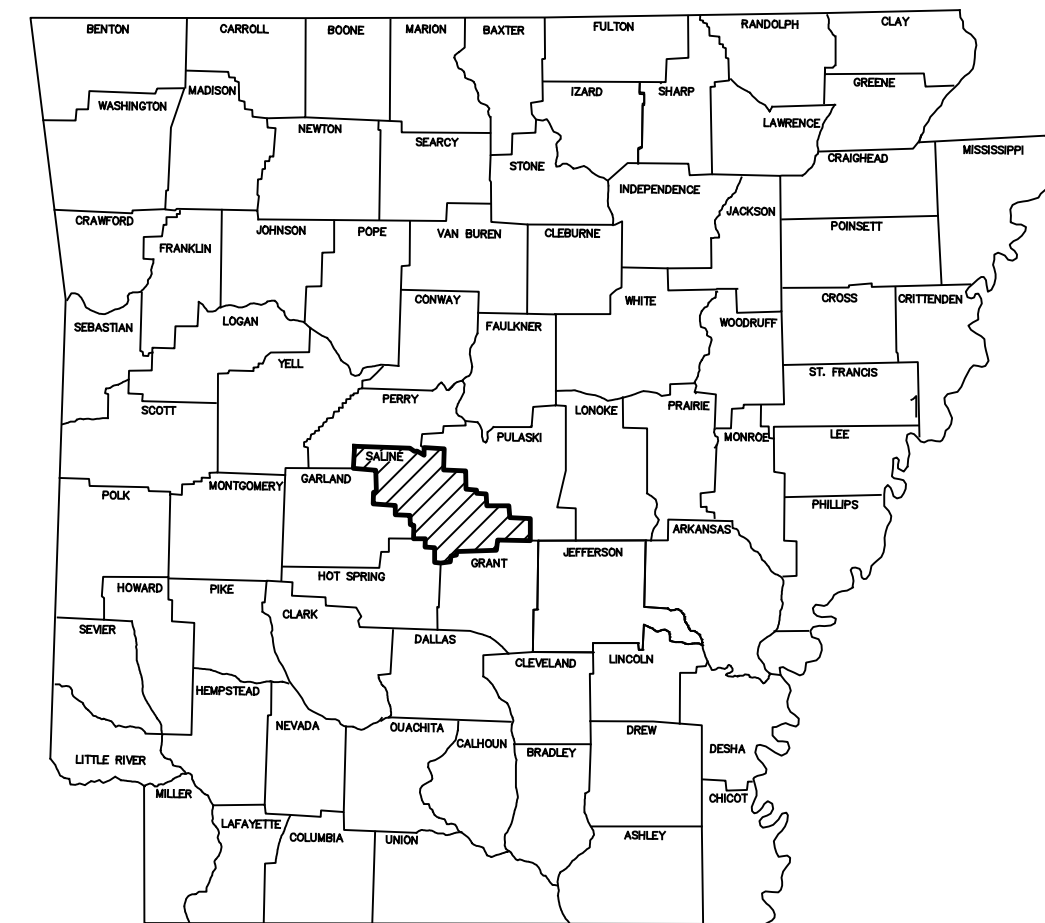

ARKANSAS

DRAWING INDEX:

- 1 PRELIMINARY PLAT
- 2 HALF STREET IMPROVEMENTS - WISE ROAD
- 3 OVERALL WATER & SEWER PLAN
- 4 STREET & DRAINAGE PLAN
- 5 MERIDIAN & SLOAN DRIVES PROFILES
- 6 WARWICK DRIVE PROFILE
- 7 NEWARK DRIVE PROFILE
- 8 WISE ROAD PROFILE

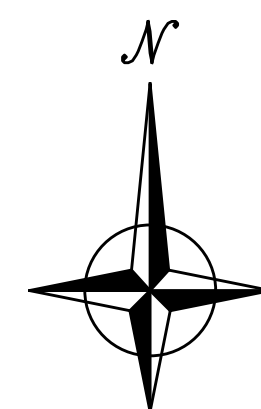

12-01-2020

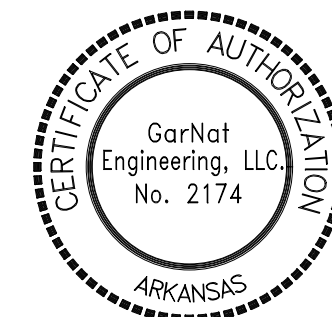

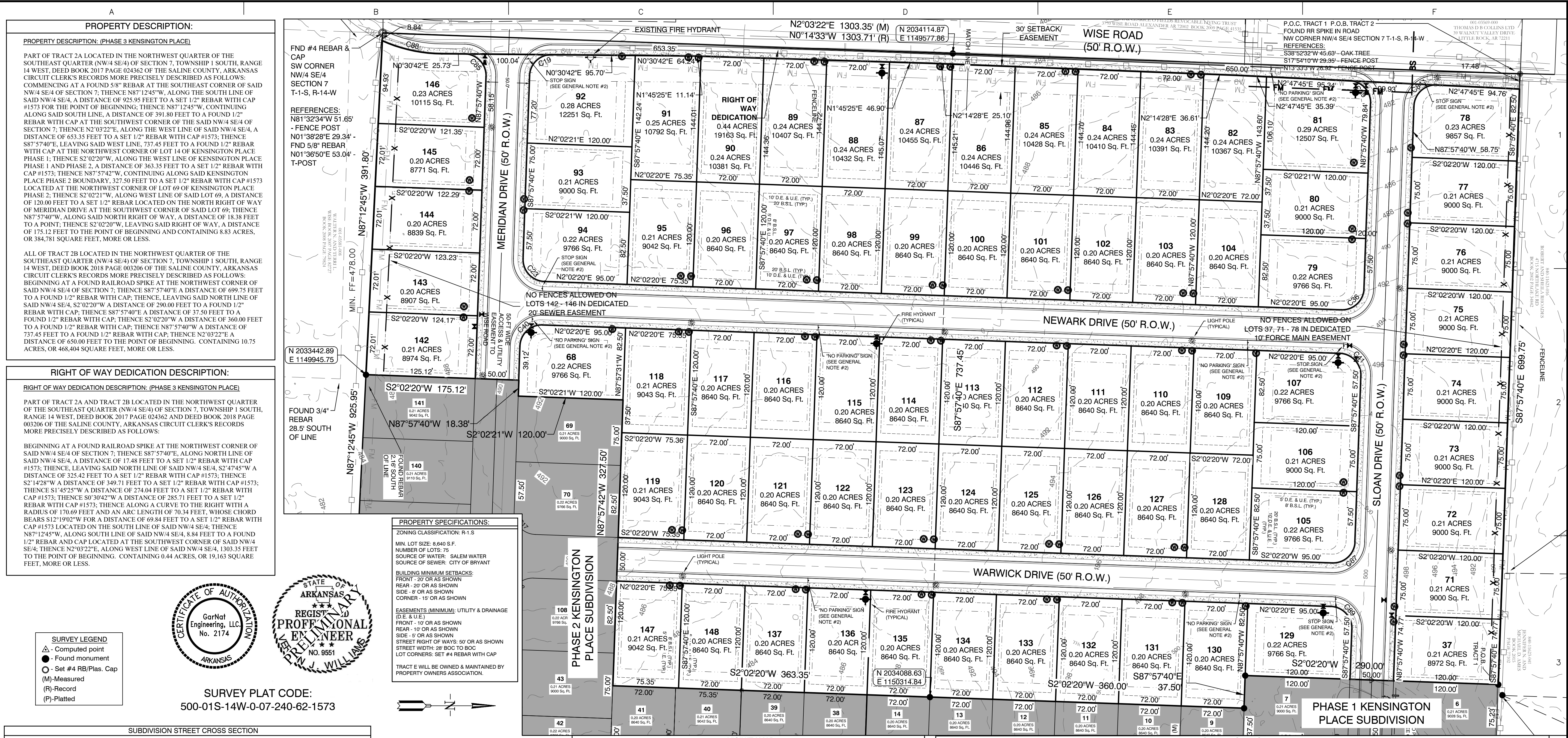

PROPERTY DESCRIPTION:
 PROPERTY DESCRIPTION: (PHASE 3 KENSINGTON PLACE)
 PART OF TRACT 2A LOCATED IN THE NORTHWEST QUARTER OF THE SOUTHEAST QUARTER (NW/4 SE/4) OF SECTION 7, TOWNSHIP 1 SOUTH, RANGE 14 WEST, DEED BOOK 2017 PAGE 024362 OF THE SALINE COUNTY, ARKANSAS CIRCUIT CLERK'S RECORDS MORE PRECISELY DESCRIBED AS FOLLOWS: COMMENCING AT A FOUND 5/8" REBAR AT THE SOUTHEAST CORNER OF SAID NW/4 SE/4 OF SECTION 7; THENCE N87°12'45"W, ALONG THE SOUTH LINE OF SAID NW/4 SE/4, A DISTANCE OF 925.95 FEET TO A SET 1/2" REBAR WITH CAP #1573 FOR THE POINT OF BEGINNING; THENCE N87°12'45"W, CONTINUING ALONG SAID SOUTH LINE, A DISTANCE OF 391.80 FEET TO A FOUND 1/2" REBAR WITH CAP AT THE SOUTHWEST CORNER OF THE SAID NW/4 SE/4 OF SECTION 7; THENCE N0°30'42"E, ALONG THE WEST LINE OF SAID NW/4 SE/4, A DISTANCE OF 653.35 FEET TO A SET 1/2" REBAR WITH CAP #1573; THENCE S87°57'40"E, LEAVING SAID WEST LINE, 737.45 FEET TO A FOUND 1/2" REBAR WITH CAP AT THE NORTHWEST CORNER OF LOT 69 OF KENSINGTON PLACE PHASE 1; THENCE S2°02'20"W, ALONG THE WEST LINE OF KENSINGTON PLACE PHASE 1 AND PHASE 2, A DISTANCE OF 363.35 FEET TO A SET 1/2" REBAR WITH CAP #1573; THENCE N87°57'42"W, CONTINUING ALONG SAID KENSINGTON PLACE PHASE 2 BOUNDARY, 327.50 FEET TO A SET 1/2" REBAR WITH CAP #1573 LOCATED AT THE NORTHWEST CORNER OF LOT 69 OF KENSINGTON PLACE PHASE 2; THENCE S2°02'21"W, ALONG WEST LINE OF SAID LOT 69, A DISTANCE OF 120.00 FEET TO A SET 1/2" REBAR LOCATED ON THE NORTH RIGHT OF WAY OF MERIDIAN DRIVE AT THE SOUTHWEST CORNER OF SAID LOT 69; THENCE N87°57'40"W, ALONG SAID NORTH RIGHT OF WAY, A DISTANCE OF 18.38 FEET TO A POINT; THENCE S2°02'20"W, LEAVING SAID RIGHT OF WAY, A DISTANCE OF 175.12 FEET TO THE POINT OF BEGINNING AND CONTAINING 8.83 ACRES, OR 384.781 SQUARE FEET, MORE OR LESS.

ALL OF TRACT 2B LOCATED IN THE NORTHWEST QUARTER OF THE SOUTHEAST QUARTER (NW/4 SE/4) OF SECTION 7, TOWNSHIP 1 SOUTH, RANGE 14 WEST, DEED BOOK 2018 PAGE 003206 OF THE SALINE COUNTY, ARKANSAS CIRCUIT CLERK'S RECORDS MORE PRECISELY DESCRIBED AS FOLLOWS: BEGINNING AT A FOUND RAILROAD SPIKE AT THE NORTHWEST CORNER OF SAID NW/4 SE/4 OF SECTION 7; THENCE S87°57'40"E, ALONG NORTH LINE OF SAID NW/4 SE/4, A DISTANCE OF 17.48 FEET TO A SET 1/2" REBAR WITH CAP #1573; THENCE LEAVING SAID NORTH LINE OF SAID NW/4 SE/4, S2°47'45"W A DISTANCE OF 325.42 FEET TO A SET 1/2" REBAR WITH CAP #1573; THENCE S2°14'28"W A DISTANCE OF 349.71 FEET TO A SET 1/2" REBAR WITH CAP #1573; THENCE S1°45'25"W A DISTANCE OF 274.04 FEET TO A SET 1/2" REBAR WITH CAP #1573; THENCE S0°30'42"W A DISTANCE OF 285.71 FEET TO A SET 1/2" REBAR WITH CAP #1573; THENCE ALONG A CURVE TO THE RIGHT WITH A RADIUS OF 170.69 FEET AND AN ARC LENGTH OF 70.34 FEET, WHOSE CHORD BEARS S12°19'02"W FOR A DISTANCE OF 69.84 FEET TO A SET 1/2" REBAR WITH CAP #1573 LOCATED ON THE SOUTH LINE OF SAID NW/4 SE/4; THENCE N87°12'45"W, ALONG SOUTH LINE OF SAID NW/4 SE/4, 8.84 FEET TO A FOUND 1/2" REBAR AND CAP LOCATED AT THE SOUTHWEST CORNER OF SAID NW/4 SE/4; THENCE N2°03'22"E, ALONG WEST LINE OF SAID NW/4 SE/4, 1303.35 FEET TO THE POINT OF BEGINNING, CONTAINING 0.44 ACRES, OR 19,163 SQUARE FEET, MORE OR LESS.

RIGHT OF WAY DEDICATION DESCRIPTION:
 RIGHT OF WAY DEDICATION DESCRIPTION: (PHASE 3 KENSINGTON PLACE)
 PART OF TRACT 2A AND TRACT 2B LOCATED IN THE NORTHWEST QUARTER OF THE SOUTHEAST QUARTER (NW/4 SE/4) OF SECTION 7, TOWNSHIP 1 SOUTH, RANGE 14 WEST, DEED BOOK 2017 PAGE 024362 AND DEED BOOK 2018 PAGE 003206 OF THE SALINE COUNTY, ARKANSAS CIRCUIT CLERK'S RECORDS MORE PRECISELY DESCRIBED AS FOLLOWS:
 BEGINNING AT A FOUND RAILROAD SPIKE AT THE NORTHWEST CORNER OF SAID NW/4 SE/4 OF SECTION 7; THENCE S87°57'40"E, ALONG NORTH LINE OF SAID NW/4 SE/4, A DISTANCE OF 17.48 FEET TO A SET 1/2" REBAR WITH CAP #1573; THENCE LEAVING SAID NORTH LINE OF SAID NW/4 SE/4, S2°47'45"W A DISTANCE OF 325.42 FEET TO A SET 1/2" REBAR WITH CAP #1573; THENCE S2°14'28"W A DISTANCE OF 349.71 FEET TO A SET 1/2" REBAR WITH CAP #1573; THENCE S1°45'25"W A DISTANCE OF 274.04 FEET TO A SET 1/2" REBAR WITH CAP #1573; THENCE S0°30'42"W A DISTANCE OF 285.71 FEET TO A SET 1/2" REBAR WITH CAP #1573; THENCE ALONG A CURVE TO THE RIGHT WITH A RADIUS OF 170.69 FEET AND AN ARC LENGTH OF 70.34 FEET, WHOSE CHORD BEARS S12°19'02"W FOR A DISTANCE OF 69.84 FEET TO A SET 1/2" REBAR WITH CAP #1573 LOCATED ON THE SOUTH LINE OF SAID NW/4 SE/4; THENCE N87°12'45"W, ALONG SOUTH LINE OF SAID NW/4 SE/4, 8.84 FEET TO A FOUND 1/2" REBAR AND CAP LOCATED AT THE SOUTHWEST CORNER OF SAID NW/4 SE/4; THENCE N2°03'22"E, ALONG WEST LINE OF SAID NW/4 SE/4, 1303.35 FEET TO THE POINT OF BEGINNING, CONTAINING 0.44 ACRES, OR 19,163 SQUARE FEET, MORE OR LESS.

PROPERTY SPECIFICATIONS:
 ZONING CLASSIFICATION: R-1-S
 MIN. LOT SIZE: 8,640 S.F.
 NUMBER OF LOTS: 75
 SOURCE OF WATER: SALEM WATER
 SOURCE OF SEWER: CITY OF BRYANT
 BUILDING MINIMUM SETBACKS:
 FRONT - 20' OR AS SHOWN
 REAR - 20' OR AS SHOWN
 SIDE - 5' OR AS SHOWN
 CORNER - 15' OR AS SHOWN
 EASEMENTS (MINIMUM): UTILITY & DRAINAGE (D.E. & U.E.)
 FRONT - 10' OR AS SHOWN
 REAR - 10' OR AS SHOWN
 SIDE - 5' OR AS SHOWN
 STREET RIGHT OF WAYS: 50' OR AS SHOWN
 STREET WIDTH: 28' BOC TO BOC
 LOT CORNERS: SET #4 REBAR WITH CAP
 TRACT # WILL BE OWNED & MAINTAINED BY PROPERTY OWNERS ASSOCIATION.

SURVEY LEGEND
 ▲ - Computed point
 ● - Found monument
 ○ - Set #4 RB/Plas. Cap
 (M) - Measured
 (R) - Record
 (P) - Platted

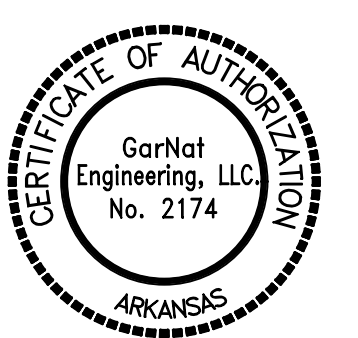

SURVEY PLAT CODE:
 500-01S-14W-0-07-240-62-1573

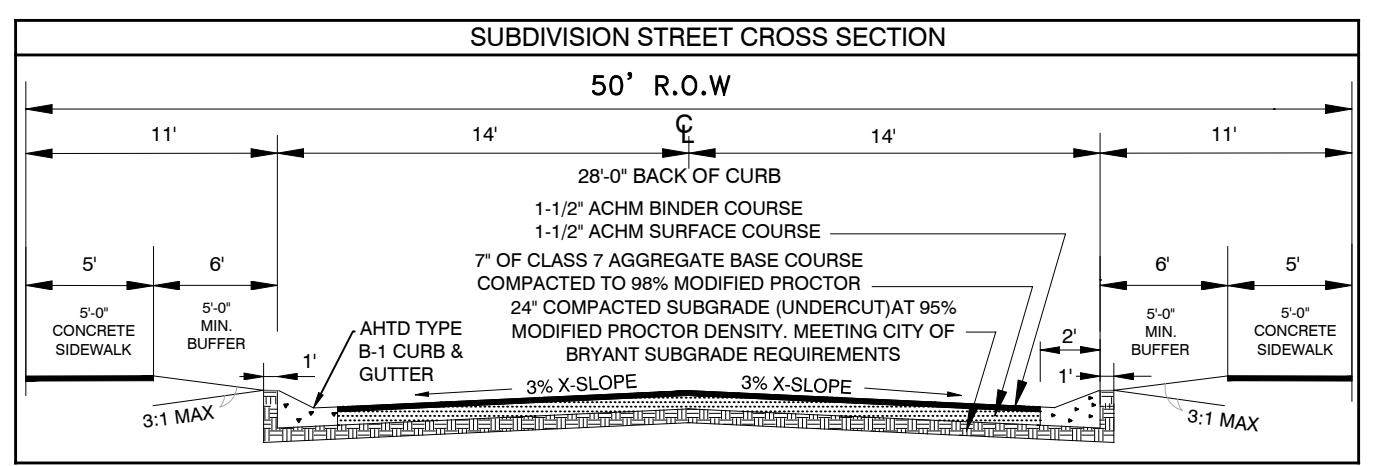

GENERAL NOTES:
 1. ALL STREETS & DRAINAGE TO MEET CITY OF BRYANT STANDARD SPECIFICATIONS & DETAILS.
 2. ALL TRAFFIC CONTROL DEVICES SHALL MEET THE REQUIREMENTS OF CITY OF BRYANT STANDARD SPECIFICATIONS PER PART 4.9

Curve Table

Curve #	Length	Radius	Delta	Chord Direction	Chord Length
C85	39.94'	25.00'	91°32'	S46°16'46"W	35.83'
C40	39.27'	25.00'	90°00'	N42°57'40"W	35.36'
C87	39.27'	25.00'	90°00'	S42°57'40"E	35.36'
C41	39.27'	25.00'	90°00'	N47°02'20"E	35.36'
C89	39.27'	25.00'	90°00'	N47°02'20"E	35.36'
C19	38.61'	25.00'	88°28'	S43°43'44"E	34.88'
C23	39.27'	25.00'	90°00'	N47°02'20"E	35.36'
C36	39.27'	25.00'	90°00'	N42°57'40"W	35.36'
C39	38.94'	25.00'	89°15'	S47°25'03"W	35.12'
C84	39.52'	25.00'	90°34'	N42°40'27"W	35.53'
C88	70.34'	170.69'	23°37'	N12°19'02"E	69.84'

KENSINGTON PLACE SUBDIVISION, PHASE 3, CITY OF BRYANT, SALINE COUNTY, ARKANSAS

BASIS OF BEARINGS:
 NAD 83 ARKANSAS GRID SOUTH ZONE (GPS)

CERTIFICATIONS:
 By affixing my seal and signature, I George P. Wooden, PLS No. 1573, hereby certify that this drawing correctly depicts a survey compiled under my supervision dated 8/18/2020.
 According to the Federal Emergency Management Agency (FEMA) Flood Insurance Rate Map (FIRM) for Saline County unincorporated areas, panel # 05125C0225E dated 6/5/2020, no portion, dated of the property described herein does lie within the 100 year flood hazard boundary.

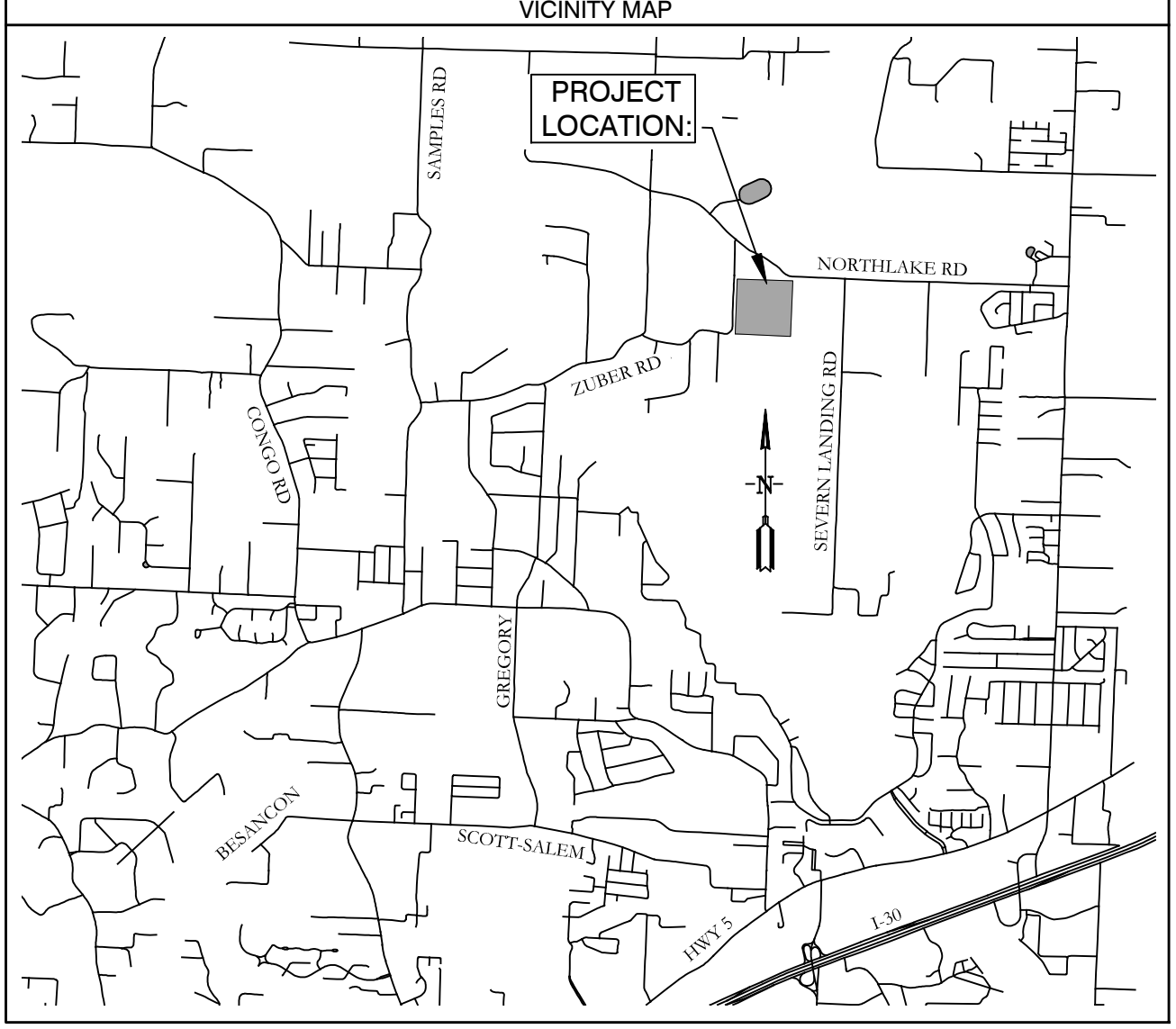

OWNER:
 Name: Thomas D.B. Collins, LTD
 Address: 39 Walnut Valley Drive, Little Rock, AR 72211

DEVELOPER:
 Name: Thomas D.B. Collins, LTD
 Address: 39 Walnut Valley Drive, Little Rock, AR 72211

CERTIFICATE OF OWNER:
 We, the undersigned, owners of the real estate shown and described herein do hereby certify that we have laid off, platted and subdivided, and do hereby lay off, plat and subdivide said real estate in accordance with the within plat.

Date: _____ Signed: Phillip Pengelly, 39 Walnut Valley Dr., Little Rock, AR 72211

CERTIFICATE OF PRELIMINARY ENGINEERING ACCURACY:
 I, Vernon J. Williams, hereby certify that this plat correctly represents a survey and a plan made by me or under my supervision; that all monuments shown hereon actually exist and their locations, size, type, and material are correctly shown; and that all requirements of the City of Bryant Subdivision Rules and Regulations have been fully complied with.

Date: _____ Signed: Vernon J. Williams, Registered Professional Engineer No. 9551, Arkansas

CERTIFICATE OF RECORDING:

CERTIFICATE OF PRELIMINARY SURVEYING ACCURACY:
 I, George P. Wooden, hereby certify that this proposed preliminary plat correctly represents a boundary survey made by me or under my supervision on 8/18/2020; that the boundary lines shown hereon correspond with the description in the deeds cited in the above Source of Title; and that all monuments which were found or placed on the property are correctly described and located.

Date: _____ Signed: George P. Wooden, Registered Land Surveyor No. 1573, Arkansas

CERTIFICATE OF PRELIMINARY PLAT APPROVAL:
 All requirements of the City of Bryant Subdivision Rules and Regulations relative to the preparation and submittal of a Preliminary Plat having been fulfilled, approval of this plat is hereby granted, subject to further provisions of said Rules and Regulations.

Date: _____ Signed: Rick Johnson, Chairman, Bryant Planning Commission

BY: GNE
 REVISION: REVISED PER CITY OF BRYANT
 DATE: 9/22/2021

Designing our client's success
GarNat Engineering, LLC
 3825 Mt Carmel Road
 Bryant, Arkansas 72022
 P.O. Box 116
 Benton, Arkansas 72018
 Ph (501) 408-4650
 gannatengr@gmail.com

KENSINGTON PLACE SUBDIVISION, PHASE 3, CITY OF BRYANT, SALINE COUNTY, ARKANSAS

PRELIMINARY PLAT

PROJECT NO: 16044
 DATE: AUGUST 2021
 SHEET NO: 1

A B C D E F

1

2

3

4

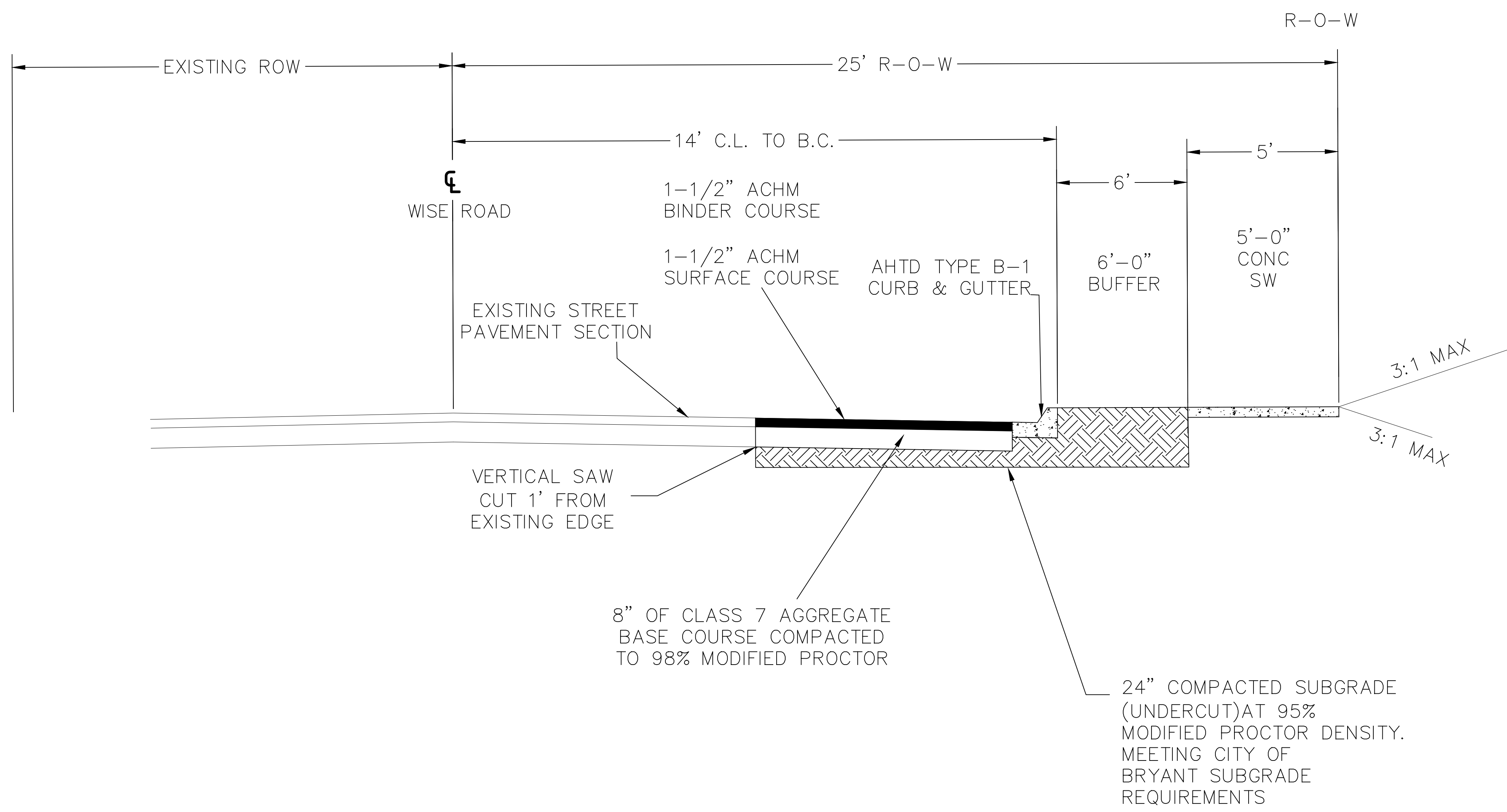

HALF-WIDENING CROSS SECTION - WISE ROAD
N.T.S.

- WISE ROAD NOTES:
1. IN AREAS TO RECEIVE BITUMINOUS PAVING, CONCRETE DRIVEWAYS OR CURB AND GUTTER, SUBGRADE SHALL BE COMPACTED TO A DENSITY OF NOT LESS THAN 95% OF MAXIMUM MODIFIED DENSITY OBTAINED AT OPTIMUM MOISTURE CONTENT.
 2. FOR AREAS OF SUBGRADE PREPARATION TO RECEIVE CONCRETE SIDEWALKS, SUBGRADE SHALL BE COMPACTED TO A DENSITY OF 90% MAXIMUM MODIFIED DENSITY.
 3. CRUSHED STONE - MATERIAL IN EACH COURSE SHALL BE COMPACTED TO A DENSITY OF 98% MAXIMUM MODIFIED DENSITY.
 4. CONCRETE SHALL HAVE A 28 DAY COMPRESSIVE STRENGTH OF 4000 PSI.

REVISION	DATE	BY

Designing our client's success
GarNat Engineering, LLC
 3825 Mt Carmel Rd
 Bryant, AR 72022
 garnatengineering@gmail.com
 P.O. Box 116
 Benton, AR 72018
 Ph: (501) 408-4650

**KENSINGTON PLACE SUBDIVISION
 PHASE 3
 CITY OF BRYANT
 SALINE COUNTY, ARKANSAS**

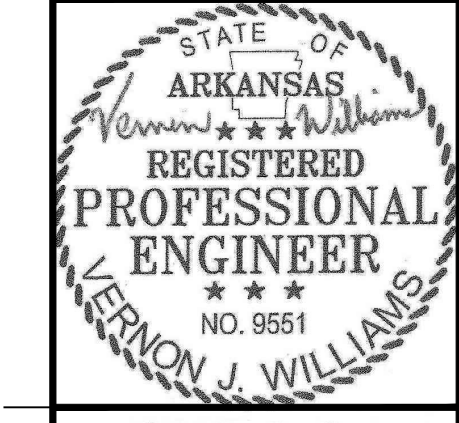

8-22-2020

CONTENTS:
HALF STREET IMPROVEMENTS - WISE ROAD

PROJECT NO:
16044

DATE:
08/20/20

SHEET NO:
2

A B C D E F

A:\Projects\2018 Projects\Phase 3\Kensington Place Subdivision - Wise Road\Phase 3\Drawings\Kensington Place Phase 3 - 08-20-20.dwg

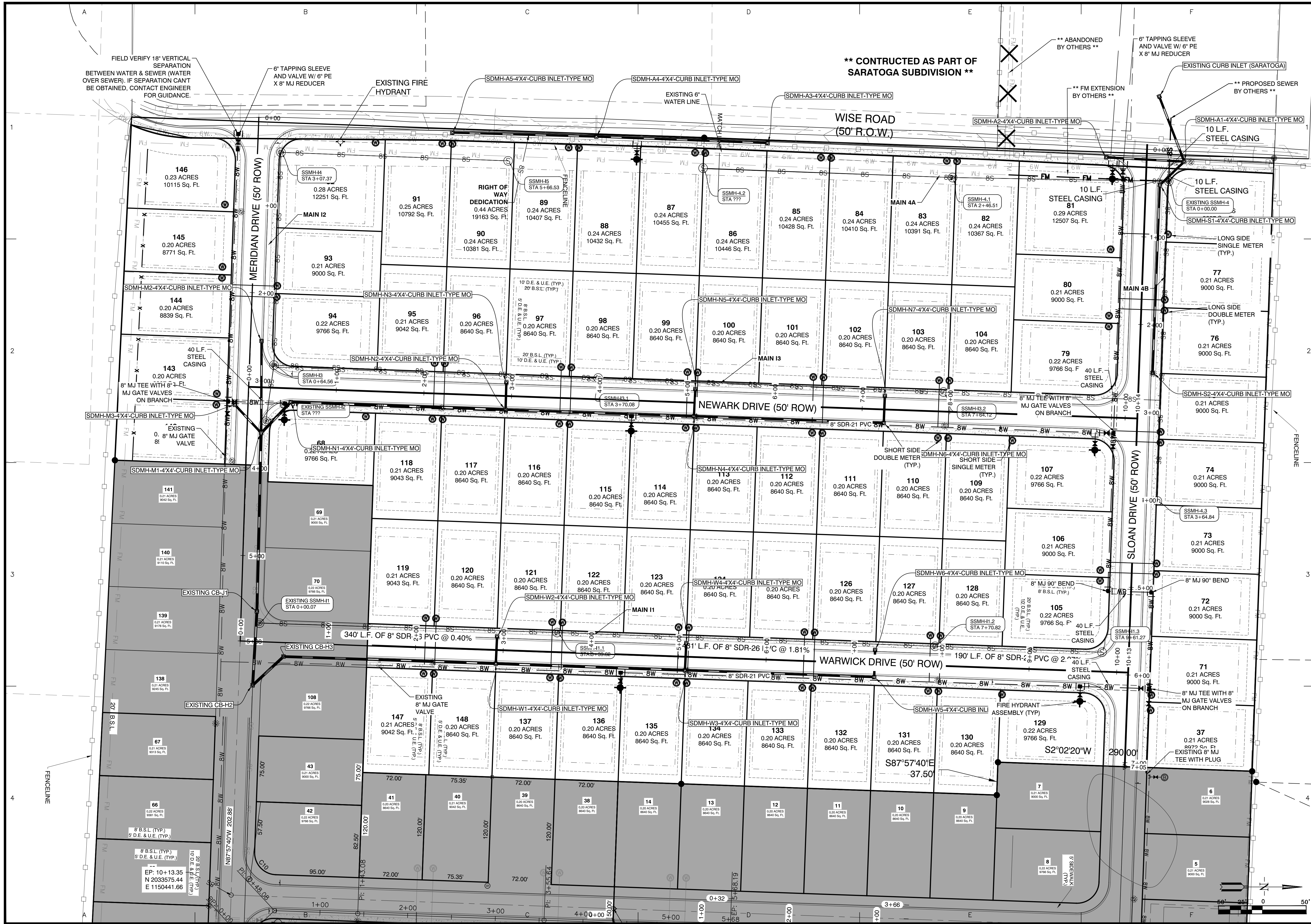

BY	SM
REVISION	REVISED PER CITY OF BRYANT
DATE	9/22/2021
<p>Designing our client's success</p> <p>GarNat Engineering, LLC 3825 Mt Carmel Rd Bryant, AR 72022 garnatengineering@gmail.com</p>	
<p>KENSINGTON PLACE SUBDIVISION PHASE 3 CITY OF BRYANT SALINE COUNTY, ARKANSAS</p>	
<p>STATE OF ARKANSAS <i>Vernon J. Williams</i> REGISTERED PROFESSIONAL ENGINEER NO. 9551 8-22-2020</p>	
<p>CONTENTS: OVERALL WATER AND SEWER PLAN</p>	
<p>PROJECT NO: 16044</p>	
<p>DATE: 08/20/20</p>	
<p>SHEET NO: 3</p>	

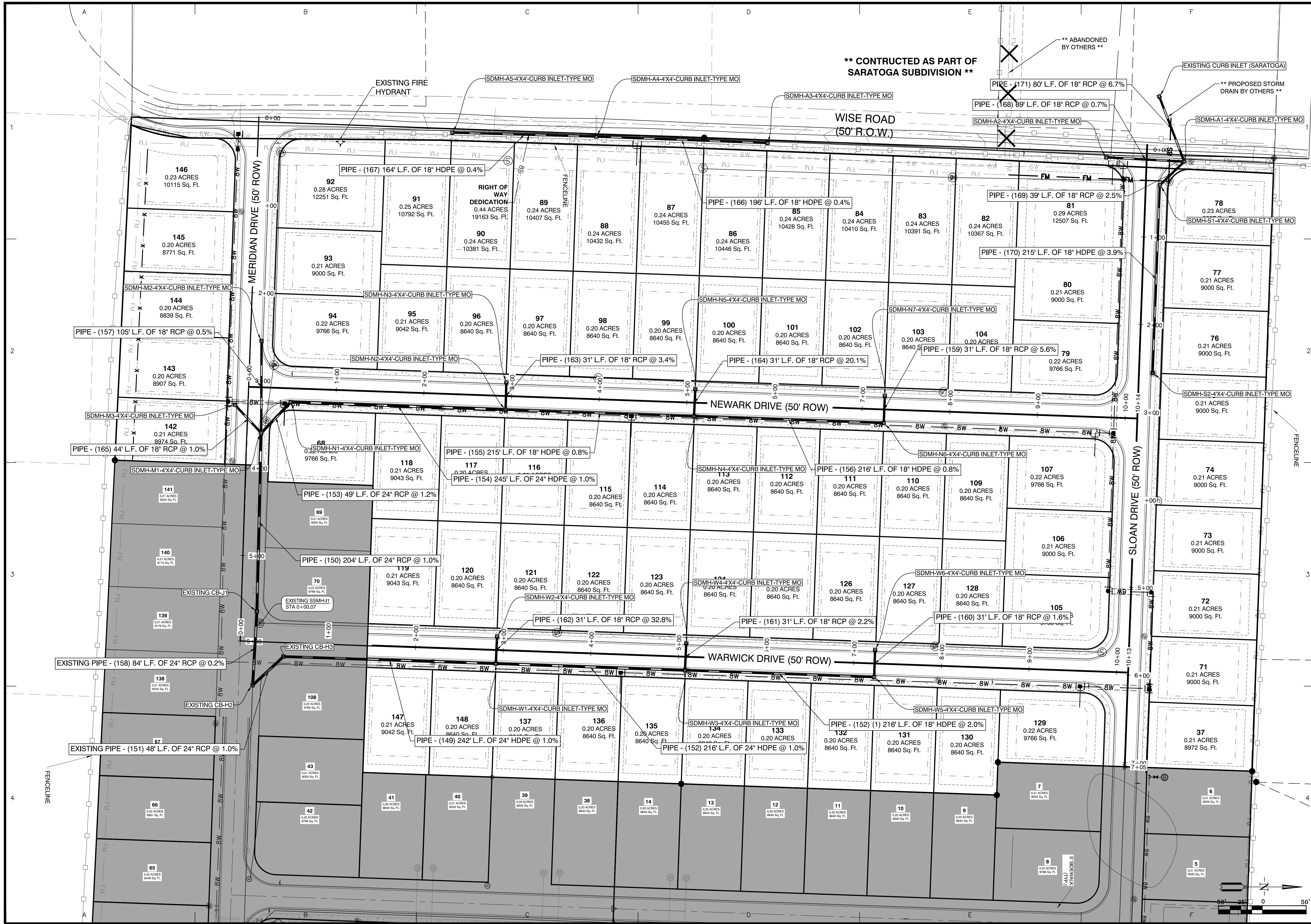

BY	SM
REVISION	REVISED PER CITY OF BRYANT
DATE	9/22/2021
<p align="center">Designing our client's success</p> <p align="center">GarNat Engineering, LLC</p> <p align="center">P.O. Box 116 Benton, AR 72018 Ph: (501) 408-4650 garnatengineering@gmail.com</p>	
<p align="center">KENSINGTON PLACE SUBDIVISION</p> <p align="center">PHASE 3</p> <p align="center">CITY OF BRYANT</p> <p align="center">SALINE COUNTY, ARKANSAS</p>	
<p align="center">STATE OF ARKANSAS <i>Vernon J. Williams</i> REGISTERED PROFESSIONAL ENGINEER NO. 9551 8-22-2020</p>	
<p>CONTENTS:</p> <p align="center">STREET & DRAINAGE PLAN</p>	
PROJECT NO:	16044
DATE:	08/20/20
SHEET NO:	4

MERIDIAN DRIVE PROFILE

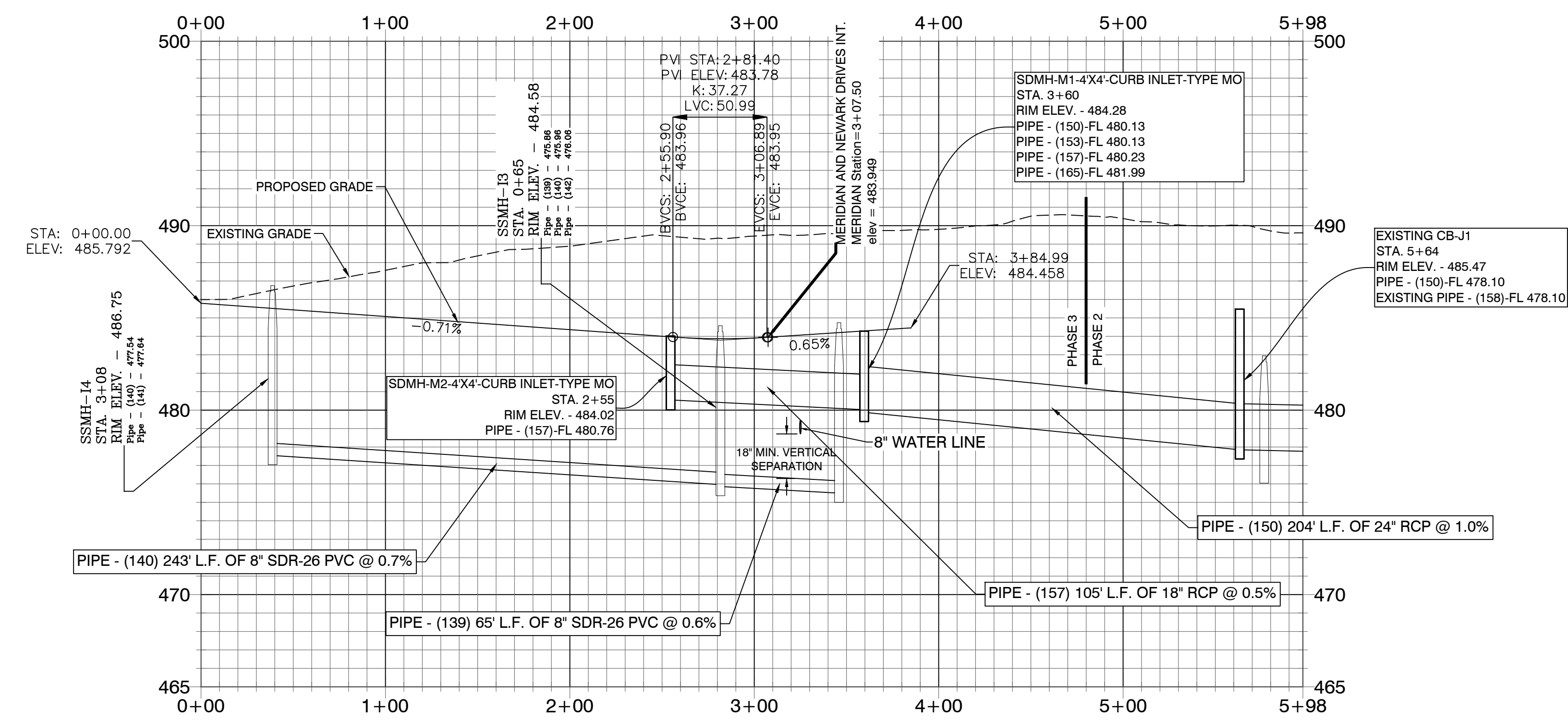

SLOAN DRIVE PROFILE

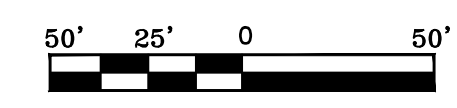
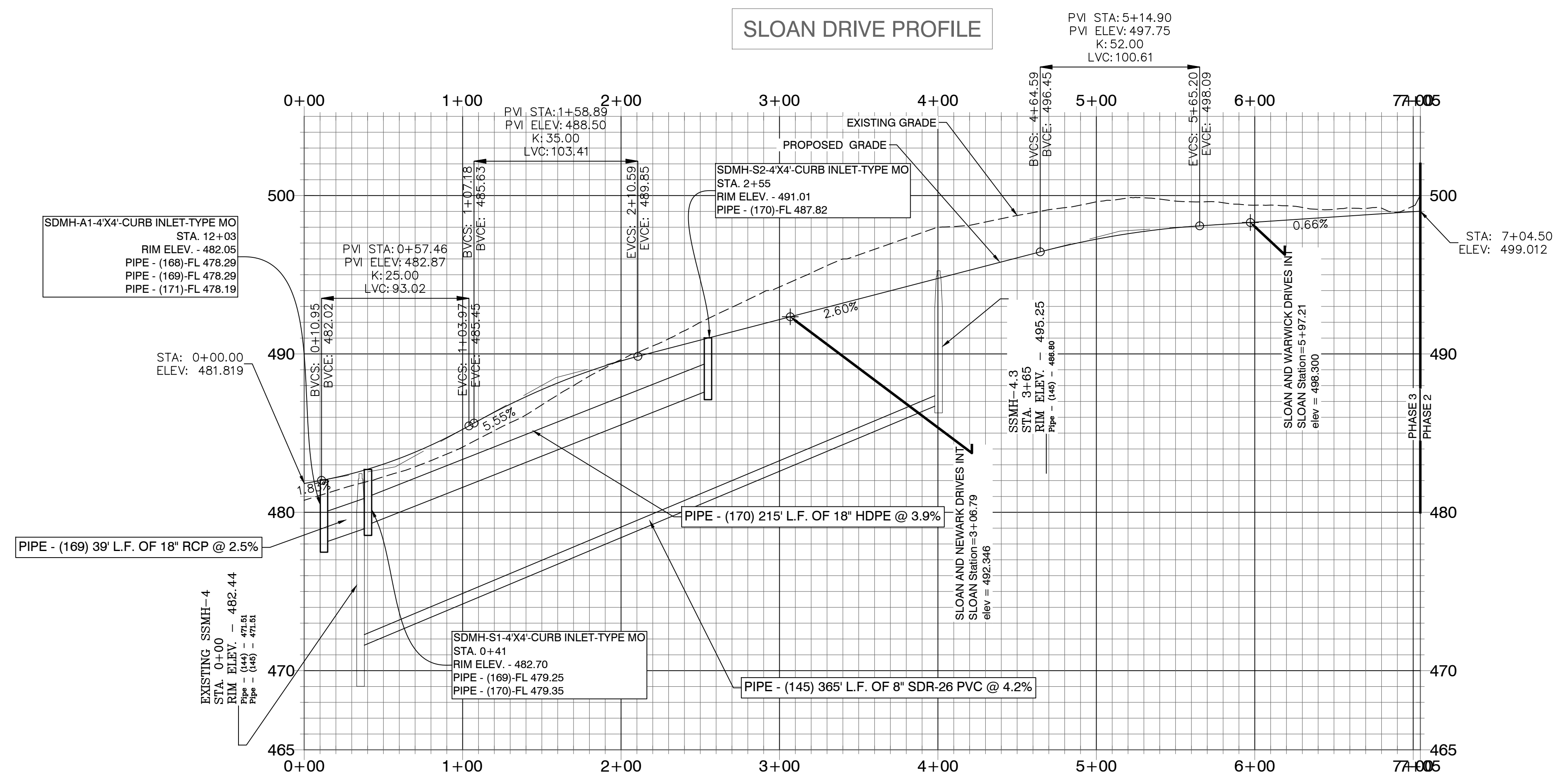

DATE	REVISION	BY
9/22/2021	REVISED PER CITY OF BRYANT	SM

GNE Designing our client's success
GarNat Engineering, LLC
 P.O. Box 116
 Benton, AR 72018
 Ph (501) 408-4650

3825 Mt Carmel Rd
 Bryant, AR 72022
 gamatengineering@gmail.com

KENSINGTON PLACE SUBDIVISION
 PHASE 3
 CITY OF BRYANT
 SALINE COUNTY, ARKANSAS

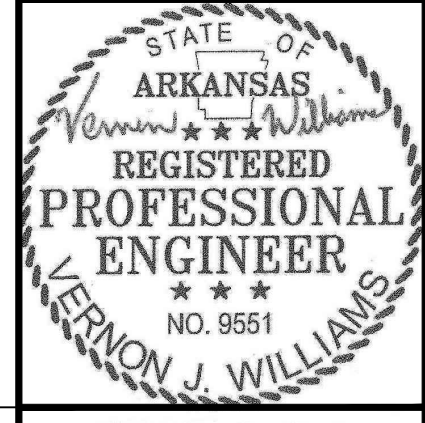

8-22-2020

CONTENTS:
 PROFILES FOR
 MERIDIAN AND
 SLOAN DRIVES

PROJECT NO:
 16044

DATE:
 08/20/20

SHEET NO:

5

J:\Projects\2018 Projects\16044_Kensington Place Subdivision - 3\Drawings\Subdivision Phase 3\Profile - 08-20-20

WARWICK DRIVE PROFILE

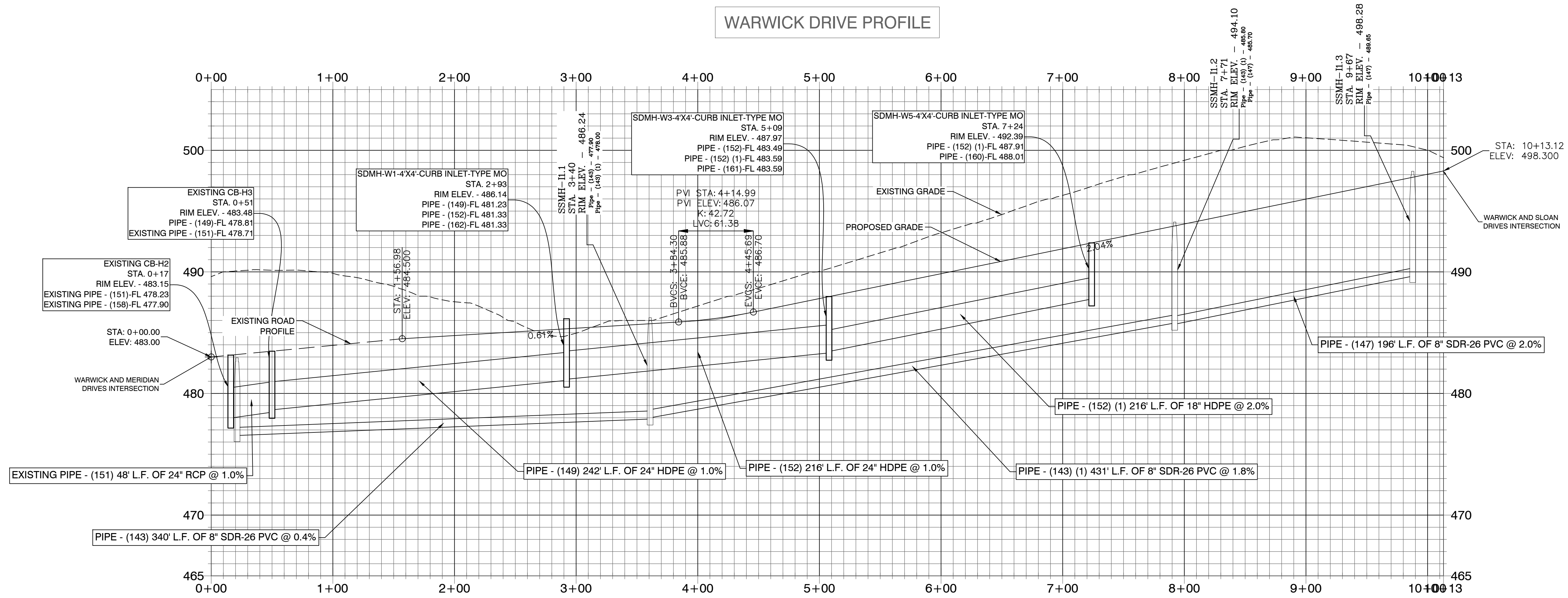

REVISION	DATE	BY

GNE Designing our client's success
GarNat Engineering, LLC
 3825 Mt Carmel Rd
 Bryant, AR 72022
 garnatengineering@gmail.com
 P.O. Box 116
 Benton, AR 72018
 Ph (501) 408-4650

**KENSINGTON PLACE SUBDIVISION
 PHASE 3
 CITY OF BRYANT
 SALINE COUNTY, ARKANSAS**



8-22-2020

CONTENTS:
WARWICK DRIVE PROFILE

PROJECT NO:
 16044

DATE:
 08/20/20

SHEET NO:

6

J:\Projects\2018 Projects\16044_Kensington Place Subdivision.dwg Project: 16044_Kensington Place Subdivision Phase 3 Drainage - 8/20/20

WISE ROAD PROFILE

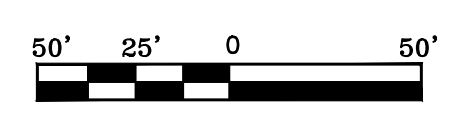
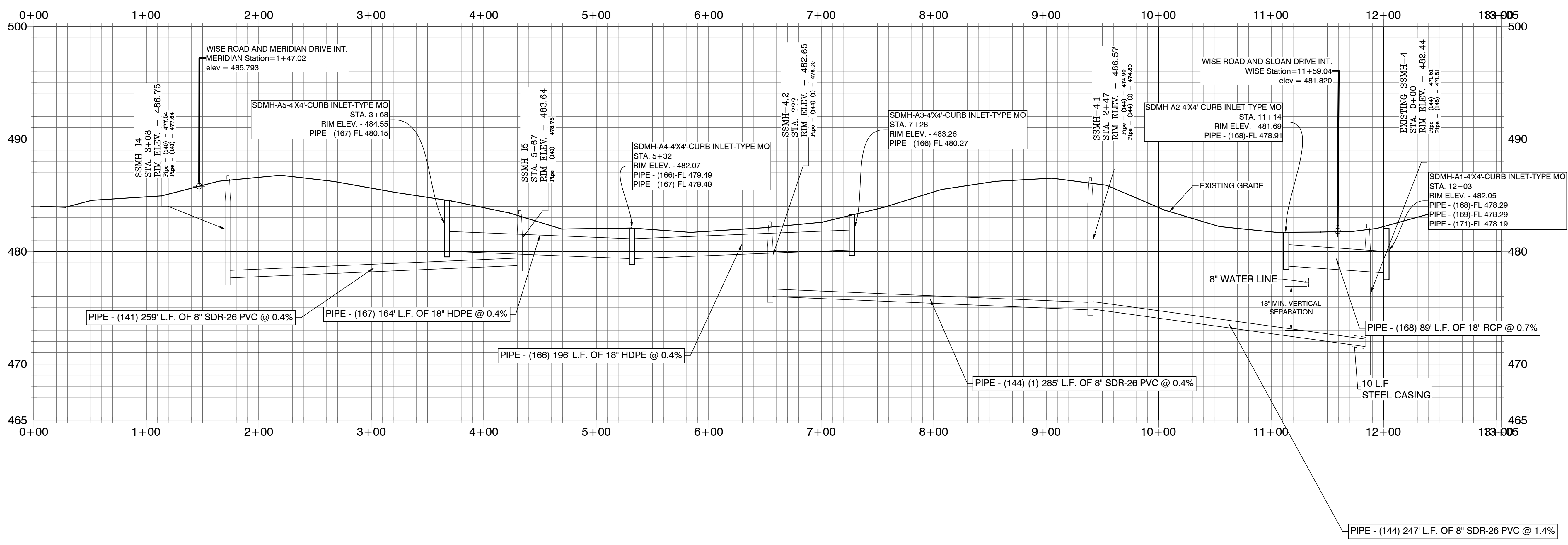

DATE	REVISION	BY
9/22/2021	REVISED PER CITY OF BRYANT	SM

GN Designing our client's success
GarNat Engineering, LLC
 P.O. Box 116
 Benton, AR 72018
 Ph: (501) 408-4650
 garnatengineering@gmail.com
 3825 Mt Carmel Rd
 Bryant, AR 72022

**KENSINGTON PLACE SUBDIVISION
 PHASE 3
 CITY OF BRYANT
 SALINE COUNTY, ARKANSAS**

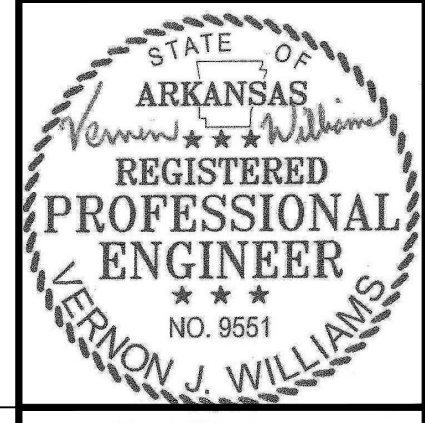

8-22-2020

CONTENTS:
WISE ROAD PROFILE

PROJECT NO:
16044

DATE:
08/20/20

SHEET NO:

8

J:\Projects\2018 Projects\16044_Kensington Place Subdivision - 3\Drawings\SUBDIVISION - PHASE 3 DRAWING - 82.dwg

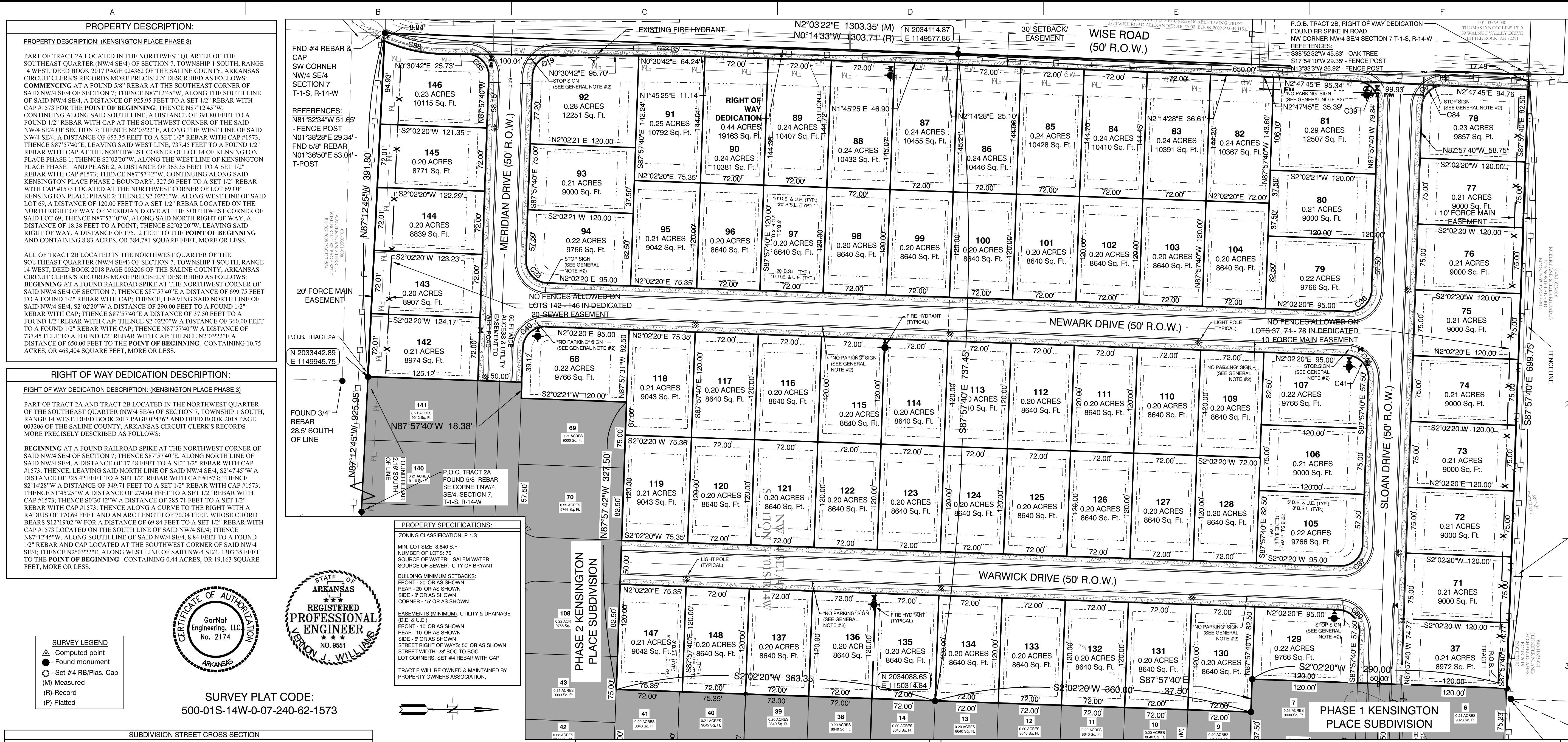

PROPERTY DESCRIPTION:
 PROPERTY DESCRIPTION: (KENSINGTON PLACE PHASE 3)
 PART OF TRACT 2A LOCATED IN THE NORTHWEST QUARTER OF THE SOUTHEAST QUARTER (NW4 SE4) OF SECTION 7, TOWNSHIP 1 SOUTH, RANGE 14 WEST, DEED BOOK 2017 PAGE 02436 OF THE SALINE COUNTY, ARKANSAS CIRCUIT CLERK'S RECORDS MORE PRECISELY DESCRIBED AS FOLLOWS:
 COMMENCING AT A FOUND 5/8" REBAR AT THE SOUTHEAST CORNER OF SAID NW4 SE4 OF SECTION 7, THENCE N87°12'45"W, ALONG THE SOUTH LINE OF SAID NW4 SE4, A DISTANCE OF 925.95 FEET TO A SET 1/2" REBAR WITH CAP #1573 FOR THE POINT OF BEGINNING, THENCE N87°12'45"W, CONTINUING ALONG SAID SOUTH LINE, A DISTANCE OF 391.80 FEET TO A FOUND 1/2" REBAR WITH CAP AT THE SOUTHWEST CORNER OF SAID NW4 SE4 OF SECTION 7, THENCE N87°12'45"W, ALONG THE WEST LINE OF SAID NW4 SE4, A DISTANCE OF 653.35 FEET TO A SET 1/2" REBAR WITH CAP #1573; THENCE S87°57'40"E, LEAVING SAID WEST LINE, 737.50 FEET TO A FOUND 1/2" REBAR WITH CAP AT THE NORTHWEST CORNER OF LOT 14 OF KENSINGTON PLACE PHASE 1; THENCE S2°02'20"W, ALONG THE WEST LINE OF KENSINGTON PLACE PHASE 1 AND PHASE 2, A DISTANCE OF 363.35 FEET TO A SET 1/2" REBAR WITH CAP #1573; THENCE N87°57'40"E, CONTINUING ALONG SAID KENSINGTON PLACE PHASE 2 BOUNDARY, 327.50 FEET TO A SET 1/2" REBAR WITH CAP #1573 LOCATED AT THE NORTHWEST CORNER OF LOT 69 OF KENSINGTON PLACE PHASE 2; THENCE S2°02'20"W, ALONG WEST LINE OF SAID LOT 69, A DISTANCE OF 120.00 FEET TO A SET 1/2" REBAR LOCATED ON THE NORTH RIGHT OF WAY OF MERIDIAN DRIVE AT THE SOUTHWEST CORNER OF SAID LOT 69; THENCE N87°57'40"E, ALONG SAID NORTH RIGHT OF WAY, A DISTANCE OF 18.38 FEET TO A POINT; THENCE S2°02'20"W, LEAVING SAID RIGHT OF WAY, A DISTANCE OF 175.12 FEET TO THE POINT OF BEGINNING AND CONTAINING 8.83 ACRES, OR 384.781 SQUARE FEET, MORE OR LESS.

ALL OF TRACT 2B LOCATED IN THE NORTHWEST QUARTER OF THE SOUTHEAST QUARTER (NW4 SE4) OF SECTION 7, TOWNSHIP 1 SOUTH, RANGE 14 WEST, DEED BOOK 2018 PAGE 003206 OF THE SALINE COUNTY, ARKANSAS CIRCUIT CLERK'S RECORDS MORE PRECISELY DESCRIBED AS FOLLOWS:
 BEGINNING AT A FOUND RAILROAD SPIKE AT THE NORTHWEST CORNER OF SAID NW4 SE4 OF SECTION 7, THENCE S87°57'40"E, ALONG NORTH LINE OF SAID NW4 SE4, A DISTANCE OF 17.48 FEET TO A SET 1/2" REBAR WITH CAP #1573; THENCE LEAVING SAID NORTH LINE OF SAID NW4 SE4, S2°47'45"W A DISTANCE OF 325.42 FEET TO A SET 1/2" REBAR WITH CAP #1573; THENCE S2°14'28"W A DISTANCE OF 349.71 FEET TO A SET 1/2" REBAR WITH CAP #1573; THENCE S1°45'23"W A DISTANCE OF 274.04 FEET TO A SET 1/2" REBAR WITH CAP #1573; THENCE S0°30'42"W A DISTANCE OF 285.71 FEET TO A SET 1/2" REBAR WITH CAP #1573; THENCE ALONG A CURVE TO THE RIGHT WITH A RADIUS OF 170.69 FEET AND AN ARC LENGTH OF 70.34 FEET, WHOSE CHORD BEARS S12°19'02"W FOR A DISTANCE OF 69.84 FEET TO A SET 1/2" REBAR WITH CAP #1573 LOCATED ON THE SOUTH LINE OF SAID NW4 SE4; THENCE N87°12'45"W, ALONG SOUTH LINE OF SAID NW4 SE4, 8.84 FEET TO A FOUND 1/2" REBAR AND CAP LOCATED AT THE SOUTHWEST CORNER OF SAID NW4 SE4; THENCE N2°03'22"E, ALONG WEST LINE OF SAID NW4 SE4, 1303.35 FEET TO THE POINT OF BEGINNING, CONTAINING 0.44 ACRES, OR 19,163 SQUARE FEET, MORE OR LESS.

RIGHT OF WAY DEDICATION DESCRIPTION:
 RIGHT OF WAY DEDICATION DESCRIPTION: (KENSINGTON PLACE PHASE 3)
 PART OF TRACT 2A AND TRACT 2B LOCATED IN THE NORTHWEST QUARTER OF THE SOUTHEAST QUARTER (NW4 SE4) OF SECTION 7, TOWNSHIP 1 SOUTH, RANGE 14 WEST, DEED BOOK 2017 PAGE 02436 AND DEED BOOK 2018 PAGE 003206 OF THE SALINE COUNTY, ARKANSAS CIRCUIT CLERK'S RECORDS MORE PRECISELY DESCRIBED AS FOLLOWS:
 BEGINNING AT A FOUND RAILROAD SPIKE AT THE NORTHWEST CORNER OF SAID NW4 SE4 OF SECTION 7, THENCE S87°57'40"E, ALONG NORTH LINE OF SAID NW4 SE4, A DISTANCE OF 17.48 FEET TO A SET 1/2" REBAR WITH CAP #1573; THENCE LEAVING SAID NORTH LINE OF SAID NW4 SE4, S2°47'45"W A DISTANCE OF 325.42 FEET TO A SET 1/2" REBAR WITH CAP #1573; THENCE S2°14'28"W A DISTANCE OF 349.71 FEET TO A SET 1/2" REBAR WITH CAP #1573; THENCE S1°45'23"W A DISTANCE OF 274.04 FEET TO A SET 1/2" REBAR WITH CAP #1573; THENCE S0°30'42"W A DISTANCE OF 285.71 FEET TO A SET 1/2" REBAR WITH CAP #1573; THENCE ALONG A CURVE TO THE RIGHT WITH A RADIUS OF 170.69 FEET AND AN ARC LENGTH OF 70.34 FEET, WHOSE CHORD BEARS S12°19'02"W FOR A DISTANCE OF 69.84 FEET TO A SET 1/2" REBAR WITH CAP #1573 LOCATED ON THE SOUTH LINE OF SAID NW4 SE4; THENCE N87°12'45"W, ALONG SOUTH LINE OF SAID NW4 SE4, 8.84 FEET TO A FOUND 1/2" REBAR AND CAP LOCATED AT THE SOUTHWEST CORNER OF SAID NW4 SE4; THENCE N2°03'22"E, ALONG WEST LINE OF SAID NW4 SE4, 1303.35 FEET TO THE POINT OF BEGINNING, CONTAINING 0.44 ACRES, OR 19,163 SQUARE FEET, MORE OR LESS.

PROPERTY SPECIFICATIONS:
 ZONING CLASSIFICATION: R-1-S
 MIN. LOT SIZE: 8,640 S.F.
 NUMBER OF LOTS: 75
 SOURCE OF WATER: SALEM WATER
 SOURCE OF SEWER: CITY OF BRYANT
 BUILDING MINIMUM SETBACKS:
 FRONT - 20' OR AS SHOWN
 REAR - 20' OR AS SHOWN
 SIDE - 8' OR AS SHOWN
 CORNER - 15' OR AS SHOWN
 EASEMENTS (MINIMUM): UTILITY & DRAINAGE (D.E. & U.E.)
 FRONT - 10' OR AS SHOWN
 REAR - 10' OR AS SHOWN
 SIDE - 5' OR AS SHOWN
 STREET RIGHT OF WAYS: 50' OR AS SHOWN
 STREET WIDTH: 28' 800 TO BOG LOT CORNERS; SET #4 REBAR WITH CAP
 TRACT # WILL BE OWNED & MAINTAINED BY PROPERTY OWNERS ASSOCIATION.

SURVEY LEGEND
 - Computed point
 - Found monument
 - Set #4 RB/Plas. Cap
 (M)-Measured
 (R)-Record
 (P)-Platted



SURVEY PLAT CODE:
 500-01S-14W-0-07-240-62-1573

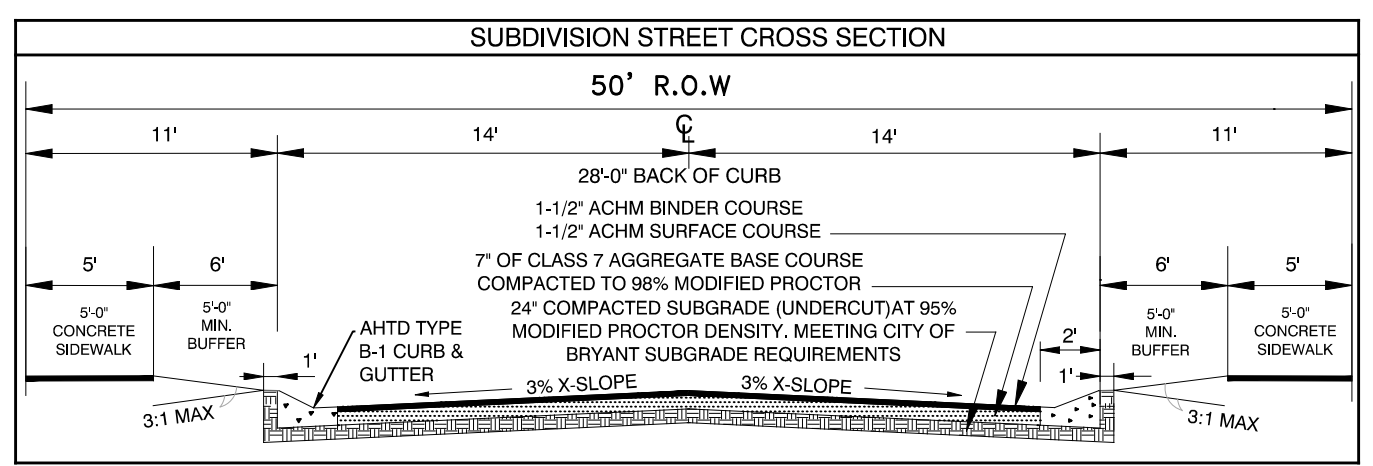

GENERAL NOTES:
 1. ALL STREETS & DRAINAGE TO MEET CITY OF BRYANT STANDARD SPECIFICATIONS & DETAILS.
 2. ALL TRAFFIC CONTROL DEVICES SHALL MEET THE REQUIREMENTS OF CITY OF BRYANT STANDARD SPECIFICATIONS PER PART 4.9

Curve Table

Curve #	Length	Radius	Delta	Chord Direction	Chord Length
C84	39.52'	25.00'	90°34'	N42°40'27"W	35.53'
C88	70.34'	170.69'	23°37'	N12°19'02"E	69.84'
C85	39.94'	25.00'	91°32'	S46°16'46"W	35.83'
C40	39.27'	25.00'	90°00'	N42°57'40"W	35.36'
C87	39.27'	25.00'	90°00'	S42°57'40"E	35.36'
C41	39.27'	25.00'	90°00'	N47°02'20"E	35.36'
C89	39.27'	25.00'	90°00'	N47°02'20"E	35.36'
C19	38.61'	25.00'	88°28'	S43°43'44"E	34.88'
C23	39.27'	25.00'	90°00'	N47°02'20"E	35.36'
C36	39.27'	25.00'	90°00'	N42°57'40"W	35.36'
C39	38.94'	25.00'	89°15'	S47°25'03"W	35.12'

KENSINGTON PLACE SUBDIVISION, PHASE 3, CITY OF BRYANT, SALINE COUNTY, ARKANSAS

BASIS OF BEARINGS:
 NAD 83 ARKANSAS GRID SOUTH ZONE (GPS)

CERTIFICATIONS:
 By affixing my seal and signature, I George P. Wooden, PLS No. 1573, hereby certify that this drawing correctly depicts a survey compiled under my supervision dated 8/18/2020.
 According to the Federal Emergency Management Agency (FEMA) Flood Insurance Rate Map (FIRM) for Saline County unincorporated areas, panel # 05125C0225E dated 6/5/2020, no portion, dated of the property described hereon does lie within the 100 year flood hazard boundary.

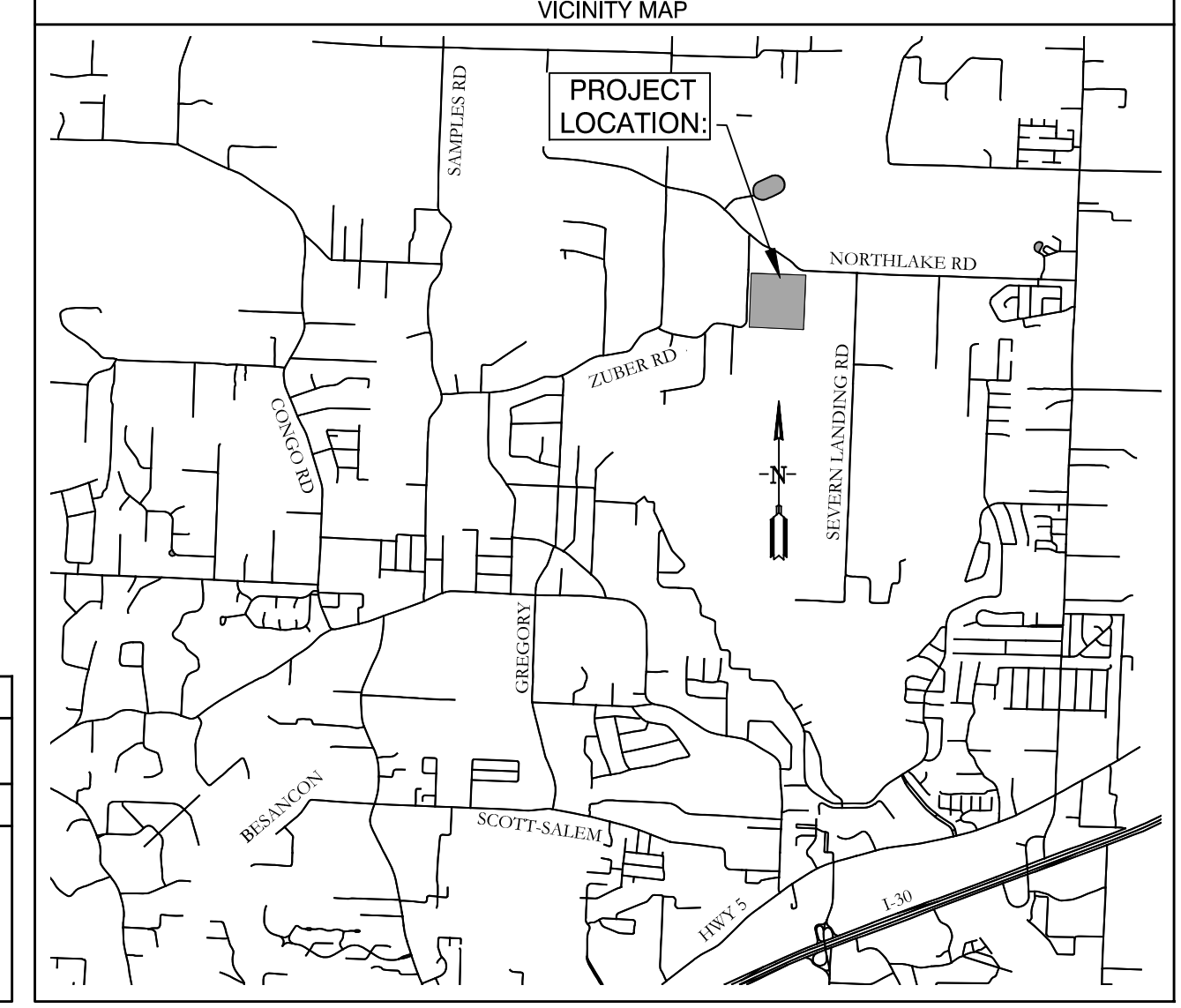

OWNER:
 Name: Thomas D.B. Collins LTD
 Address: 9360 Gilbert Road, Benton, AR 72019

DEVELOPER:
 Name: Thomas D.B. Collins LTD
 Address: 9360 Gilbert Road, Benton, AR 72019

CERTIFICATE OF OWNER:
 We, the undersigned, owners of the real estate shown and described herein do hereby certify that we have laid off, platted and subdivided, and do hereby lay off, plat and subdivide said real estate in accordance with the within plat.
 Date: _____ Signed: _____
 Name: Phillip Pengelly
 Address: 9360 Gilbert Road, Benton, Arkansas 72019

CERTIFICATE OF ENGINEERING ACCURACY:
 I, Vernon J. Williams, hereby certify that this plat correctly represents a survey and a plan made by me or under my supervision; that all monuments shown hereon actually exist and their locations, size, type, and material are correctly shown; and that all requirements of the City of Bryant Subdivision Rules and Regulations have been fully complied with.
 Date: _____ Signed: _____
 Vernon J. Williams
 Registered Professional Engineer
 No. 9551, Arkansas

CERTIFICATE OF RECORDING:

CERTIFICATE OF SURVEYING ACCURACY:
 I, George P. Wooden, hereby certify that this plat correctly represents a boundary survey made by me or under my supervision on August 18, 2020; that the boundary lines shown hereon correspond with the description in the deeds cited in the above Source of Title; and that all monuments which were found or placed on the property are correctly described and located.
 Date: _____ Signed: _____
 George P. Wooden
 Registered Land Surveyor
 No. 1573, Arkansas

CERTIFICATE OF FINAL PLAT APPROVAL:
 Pursuant to the City of Bryant Subdivision Rules and Regulations, this document was given approval by the Bryant Planning Commission at a meeting held December 11, 2023. All of the document is hereby accepted, and this certificate executed under the authority of said rules and regulations.
 Date: _____ Signed: _____
 Rick Johnson, Chairman
 Bryant Planning Commission

BY _____

REVISION _____

DATE _____

GNE Designing our client's success
GarNat Engineering, LLC
 3825 Mt Carmel Road
 Bryant, Arkansas 72022
 P.O. Box 116
 Benton, Arkansas 72018
 Ph (501) 408-4650
 gannatengr@gmail.com

KENSINGTON PLACE SUBDIVISION, PHASE 3, CITY OF BRYANT, SALINE COUNTY, ARKANSAS

REGISTERED PROFESSIONAL SURVEYOR
 STATE OF ARKANSAS
 NO. 1573
 SIGNATURE
 GEORGE P. WOODEN

CONTENTS:
FINAL PLAT

PROJECT NO:
16044

DATE:
NOV. 2023

SHEET NO:
1

J:\Projects\2023\Projects\16044\Kensington Place\Drawings\Subdivision\Phase 3\Final\16044-Subdivision-Phase 3-Final-PLAT-100223.dwg

**BILL OF ASSURANCE
KENSINGTON PLACE SUBDIVISION
PHASE 2 AND PHASE 3**

PART A. PREAMBLE

WHEREAS, THOMAS D.B. COLLINS, LTD. is the Owner, by virtue of Instrument 2016-017259 and 2017-023009, of the following land situated in Saline County, Arkansas, to wit:

PART OF TRACT 2A LOCATED IN THE NORTHWEST QUARTER OF THE SOUTHEAST QUARTER (NW/4 SE/4) OF SECTION 7, TOWNSHIP 1 SOUTH, RANGE 14 WEST, DEED BOOK 2017 PAGE 024362 OF THE SALINE COUNTY, ARKANSAS CIRCUIT CLERK'S RECORDS MORE PRECISELY DESCRIBED AS FOLLOWS: COMMENCING AT A FOUND 5/8" REBAR AT THE SOUTHEAST CORNER OF SAID NW/4 SE/4 OF SECTION 7; THENCE N87°12'45"W, ALONG THE SOUTH LINE OF SAID NW/4 SE/4, A DISTANCE OF 925.95 FEET TO A SET 1/2" REBAR WITH CAP #1573 FOR THE POINT OF BEGINNING; THENCE N87°12'45"W, CONTINUING ALONG SAID SOUTH LINE, A DISTANCE OF 391.80 FEET TO A FOUND 1/2" REBAR WITH CAP AT THE SOUTHWEST CORNER OF THE SAID NW/4 SE/4 OF SECTION 7; THENCE N2°03'22"E, ALONG THE WEST LINE OF SAID NW/4 SE/4, A DISTANCE OF 653.35 FEET TO A SET 1/2" REBAR WITH CAP #1573; THENCE S87°57'40"E, LEAVING SAID WEST LINE, 737.45 FEET TO A FOUND 1/2" REBAR WITH CAP AT THE NORTHWEST CORNER OF LOT 14 OF KENSINGTON PLACE PHASE 1; THENCE S2°02'20"W, ALONG THE WEST LINE OF KENSINGTON PLACE PHASE 1 AND PHASE 2, A DISTANCE OF 363.35 FEET TO A SET 1/2" REBAR WITH CAP #1573; THENCE N87°57'42"W, CONTINUING ALONG SAID KENSINGTON PLACE PHASE 2 BOUNDARY, 327.50 FEET TO A SET 1/2" REBAR WITH CAP #1573 LOCATED AT THE NORTHWEST CORNER OF LOT 69 OF KENSINGTON PLACE PHASE 2; THENCE S2°02'21"W, ALONG WEST LINE OF SAID LOT 69, A DISTANCE OF 120.00 FEET TO A SET 1/2" REBAR LOCATED ON THE NORTH RIGHT OF WAY OF MERIDIAN DRIVE AT THE SOUTHWEST CORNER OF SAID LOT 69; THENCE N87°57'40"W, ALONG SAID NORTH RIGHT OF WAY, A DISTANCE OF 18.38 FEET TO A POINT; THENCE S2°02'20"W, LEAVING SAID RIGHT OF WAY, A DISTANCE OF 175.12 FEET TO THE POINT OF BEGINNING AND CONTAINING 8.83 ACRES, OR 384,781 SQUARE FEET, MORE OR LESS.

ALL OF TRACT 2B LOCATED IN THE NORTHWEST QUARTER OF THE SOUTHEAST QUARTER (NW/4 SE/4) OF SECTION 7, TOWNSHIP 1 SOUTH, RANGE 14 WEST, DEED BOOK 2018 PAGE 003206 OF THE SALINE COUNTY, ARKANSAS CIRCUIT CLERK'S RECORDS MORE PRECISELY DESCRIBED AS FOLLOWS: BEGINNING AT A FOUND RAILROAD SPIKE AT THE NORTHWEST CORNER OF SAID NW/4 SE/4 OF SECTION 7; THENCE S87°57'40"E A DISTANCE OF 699.75 FEET TO A FOUND 1/2" REBAR WITH CAP; THENCE, LEAVING SAID NORTH LINE OF SAID NW/4 SE/4, S2°02'20"W A DISTANCE OF 290.00 FEET TO A FOUND 1/2" REBAR WITH CAP; THENCE S87°57'40"E A DISTANCE OF 37.50 FEET TO A FOUND 1/2" REBAR WITH CAP; THENCE S2°02'20"W A DISTANCE OF 360.00 FEET TO A FOUND 1/2" REBAR WITH CAP;

THENCE N87°57'40"W A DISTANCE OF 737.45 FEET TO A FOUND 1/2" REBAR WITH CAP; THENCE N2°03'22"E A DISTANCE OF 650.00 FEET TO THE POINT OF BEGINNING. CONTAINING 10.75 ACRES, OR 468,404 SQUARE FEET, MORE OR LESS.

WHEREAS, Owner has caused said land to be surveyed and a plat thereof made, dividing said land into lots as shown on said plat and showing the dimensions of each lot and the width of the streets as known as KENSINGTON PLACE SUBDIVISION, PHASE 2 AND PHASE 3, Saline County, Arkansas.

WHEREAS, the Saline County Real Estate Assessor and Office of Emergency Services have approved said Subdivision and road names.

NOW THEREFORE, Thomas D.B. Collins, Ltd., in consideration of the purposes herein stated, does hereby designate said land and make part hereof to be known as KENSINGTON PLACE SUBDIVISION, PHASE 2 AND PHASE 3, to the City of Bryant, Saline County, Arkansas, and that hereafter any conveyance by the Owners of said land by lot number shall forever be held to be good and legal description and the streets shown on said plat in said Subdivision are hereby and will become a public road to be accepted by Saline County for maintenance. The property owners of KENSINGTON PLACE SUBDIVISION are subject to and are joined as members of the KENSINGTON PLACE Property Owner's Association for the purpose of maintaining and ownership of common areas and appurtenants belonging thereto. The use of the land in said Subdivision being subject to the following Protective and Restrictive Covenants:

PART B. AREA OF APPLICATION

B-1 FULLY PROTECTED RESIDENTIAL AREA. The residential area covenants in Part C in their entirety shall apply to the entire Subdivision.

PART C: RESIDENTIAL AREA COVENANTS:

C-1 LAND USE AND BUILDING TYPE. No lot shall be used except for residential purposes. Not business of any nature or kind shall at any time be conducted in any building located on any of the lots. No building shall be erected, altered, placed or allowed to remain on any lot other than one detached, single-family dwelling not to exceed two stories in height, excluding basement area. No lot can be subdivided for any purpose without the prior approval from the Saline County Planning Board and the consent of 51 % of the voting members of the Property owners associations.

C-2 ARCHITECTURAL CONTROL. No dwelling or structure shall be erected, placed or altered on any lot until the construction plans and specifications and a plan showing the location of the structure, including landscaping, have been approved by the architectural control committee as to quality of workmanship and materials, harmony of external design with existing structures, and as to location with respect to topography and finish grade elevation, and intended objectives of

the Architectural Control Committee to achieve a subdivision that accomplishes the desired architectural design in the structure and subdivision ascetics. No fence or wall shall be erected, placed or altered on any lot nearer than the setbacks as shown on the Plat. The term structure is defined to include any and all types of fences, antennas, decks, basketball goals, swimming pools and television satellite dishes, which in no event shall be placed in front of dwellings. Each property owner requesting approval shall submit to the Architectural Control Committee at least two weeks prior to the time approval is needed, a complete set of house plans and completed material and specifications list. Approval shall be a provided in Part D.

C-3 DWELLING COST, QUALITY AND SIZE. No dwelling shall be permitted on any lot unless the dwelling has at least 1,800 square feet, it being the intention and purpose of the covenants to assure that all dwellings shall be of a quality of workmanship and materials substantially the same or better than that for the minimum permitted dwelling size. Each dwelling shall have a minimum of a two car garage. No open carports are allowed. No manufactured houses are allowed, site built homes only.

C-4 BUILDING LOCATION. No building shall be located on any lot, nearer to the side street line, than the minimum building set back lines as shown on the recorded plat. For the purposes of this covenant, eaves and steps shall not be considered as part of the building. No lot shall be subdivided and no more than one dwelling shall be permitted on any one lot.

C-5 BUILDING REQUIREMENTS. All buildings shall have roof pitch of no less than 6/12. A 2 car enclosed garage, No chain link fences shall be allowed, and all fences shall be of a wood type approved by the Architectural control committee.

C-6 EASEMENTS. Easements for installation and maintenance of utilities and drainage facilities, and construction, repair and maintenance of adequate walls, roofs and eaves are reserved as shown on recorded plat.

C-7 NUISANCES. No noxious or offensive trade or activities shall be carried on, nor shall anything be done thereon which may be or become a nuisance to the neighborhood.

C-8 TEMPORARY STRUCTURES. No structure of a temporary character, basement, tent, shack, garage, barn or other out building shall be used on any tract at any time as a residence either temporarily or permanently; except that the developer may have a temporary construction and/or sales office.

C-9 OUTBUILDINGS. One outbuilding for storage shall be permitted, if approved by the Architectural Control Committee and shall conform to the same architectural design and construction of the dwelling. Above ground swimming pools are prohibited.

C-10 SIGNS. No sign of any kind shall be displayed to the public view on any lot, except, one professional sign of not more than one square foot; one sign of not more than five square feet advertising the property for sale or rent or any signs used by a builder to advertise the property during the construction and sales period.

C-11 OWNER RESPONSIBILITY. Any property owner shall insure that any contractor performing services for the property owner shall comply with the provisions of this Bill of Assurance.

C-12 CONTRACTOR RESPONSIBILITY. No contractor shall damage in any way the utilities or streets in any manner.

C-13 OIL AND MINING OPERATIONS. No oil drilling, oil development operations, oil refining, quarrying or mining operations of any kind shall be permitted upon or in any lot, nor shall oil wells, tanks, tunnels, mineral excavations or shafts be permitted upon or in any lot. No derrick or structures designated for use in boring for oil or natural gas shall be erected, maintained or permitted upon any lot.

C-14 LIVESTOCK AND POULTRY. No animals, livestock or poultry of any kind may be raised, bred or kept on any tract, except that dogs or cats may be kept, on any lot provided that they are not kept, bred or maintained for any commercial purpose and provided that facilities for maintenance of same are approved by the Architectural Control Committee and that the keeping of same does not constitute a nuisance.

C-15 GARBAGE AND REFUSE DISPOSAL. No lot or easement shall be used or maintained as a dumping ground for rubbish. Trash, garbage and other waste shall not be kept except in sanitary containers. There shall be no burning of trash, rubbish, leaves or yard waste.

C-16 SIGHT DISTANCE AT INTERSECTIONS. No fence, wall, hedge or shrub planting which obstructs sight lines at elevations between 2 and 6 feet above the roadways shall be placed or permitted to remain on any lot corner which the triangular area formed by the street property lines and the line connecting them at points 15 feet from the intersection of street right of way lines, or in the case of a rounded property corner, from the intersection of the street property line extended. The same sight line limitations shall apply on any lot within 10 feet from the intersection of the street property line with the edge of a driveway pavement. No tree shall be permitted to remain within such distances or such intersections unless the foliage line is maintained at sufficient height to prevent obstruction of such sight lines.

C-17 LOT, YARD AND HOME MAINTENANCE. All property owners, after acquisition of any lot, shall keep all grounds and yards mowed, trimmed and clean. All houses shall be painted and stained. No deviation from the original plans shall be permitted without approval of the Architectural Control Committee.

C-18 COMMENCEMENT OF CONSTRUCTION. A property owner must start construction of an approved dwelling within a period of one (1) year from date of purchase. The developer reserves the option to repurchase any lot for the amount of the original purchase price if construction is not commenced within such period of time. This option shall be exercised in writing within a period of thirty (30) days after the one (1) year period.

C-19 COMPLETION OF CONSTRUCTION. Any dwelling must be completed in its entirety within a period of one year from date such construction is commenced.

C-20 MOTOR VEHICLE PARKING. Abandoned or unused motor vehicles shall not be parked or permitted to remain on any lot or within the dedicated street. Boats, recreational vehicles and trailers cannot be parked at the front or side of any dwelling or in the dedicated street and must be parked in back of the dwelling. Owners or permanent residents are prohibited from parking in the street. There shall be no non-functioning vehicles kept on the lot or in view of the public. There shall be no repair work done outside of the garage.

C-21 MINIMUM FLOOR LEVEL ELEVATIONS. The Architectural Control Committee reserves the right to prescribe the minimum floor elevations for lots. All homes shall have a minimum floor elevation of one foot above the back of the curb unless waived in writing by the Architectural Control Committee.

C-22 SEWER SERVICE. No Septic systems shall be allowed on individual lots.

PART D. ARCHITECTURAL CONTROL COMMITTEE:

D-1 MEMBERSHIP. The Architectural Control Committee shall be composed of Jody Petty, Kelsey Kehrees and Mark Kehrees. A majority of the committee may designate a representative to act for it. In the event of death or resignation of any member of the committee, the remaining members shall have full authority to designate a successor. Neither the members of the committee nor its designated representative shall be entitled to any compensation for thence services performed pursuant to this covenant.

D-2 PROCEDURE. The committee's approval or disapproval as required in these covenants shall be in writing and in the form hereto attached marked Exhibit "A" which, when executed, should be retained by the owner/builder as proof of the Committee's approval. In the event the committee or its designated representative fails to approve or disapprove within 30 days after plans and specification have been submitted to it or in the event no suit to enjoin the construction or compliance with these covenants has been commenced within 180 days after the completion thereof will not be required and the related covenants shall be deemed to have been fully complied with. The Committee will with Buyer's will with Buyer's permission and at the expense of the Buyer refer Buyer's plan to an architect for revisions and changes to comply with the Bill of Assurance.

PART E. PROPERTY OWNERS ASSOCIATION

E-1 OWNERS EASEMENTS OF ENJOYMENT. Every owner shall have a right and easement of enjoyment in and to the common area which shall be appurtenant to and shall pass with the title to every tract. Subject to the following provision:

- (a) The right of the Association to charge reasonable fees for maintenance of the

common area;

E-2 MEMBERSHIP AND VOTING RIGHTS

SECTION 1: Every owner of a tract which is subject of assessment shall be a member of the Association. Membership shall be appurtenant to and may not be separated from ownership of any tract which is subject to assessment.

SECTION 2: The Association shall have two classes of voting membership:

Class A: Class A members shall be all owners, with the exception of the Declarant, and shall be entitled to one vote for each tract owned, which may be voted at such time as all tracts are sold by the Declarant. When more than one person holds an interest in any tract, all such persons shall be members. The vote for such tract shall be exercised as they determine, but in no event shall more than one vote be cast with respect to any Tract.

Class B: The Class B member(s) shall be the Declarant and shall be entitled to ten votes per tract owned. The Class B membership shall cease on the happening of the following events.

(a) when all tracts are sold by declarant.

E-3 COVENANT FOR MAINTENANCE ASSESSMENTS

SECTION 1: Creation of the Lien and Personal Obligation of Assessments: The Declarant, for each tract owned within the properties, hereby covenants, and each owner of any tract by acceptance of a deed therefore, whether or not it shall be so expressed in such deed, is deemed to covenant and agree to pay to the Association annual assessment or charges, such assessments to be established and collected as hereinafter provided. The annual assessments, together with interest, costs and reasonable attorneys' fees, shall be a charge on the land and shall be a continuing lien upon the property against which each such assessment is made. Each such assessment, together with interest, costs, and reasonable attorneys' fees, shall also be the personal obligation of the person who is the owner of such property at the time when the assessment fell due. The personal obligation for delinquent assessments shall not pass to his successors in title unless expressly assumed by them.

SECTION 2: Purpose of Assessment: The assessments levied by the Association shall be used as follows:

- (a) For the maintenance and upkeep of all common areas
- (b) For any other purposes deemed in the best interest of the property owners by the Association

SECTION 3: Annual Assessment: Commencing on the date of filing of this Bill of Assurance, the property owners association will assume total responsibility for operation and maintenance of amenities and common areas and assess each property owner and annual assessment of \$100.00, which shall commence as to all Lots on the first day of January following the date of recordation of this instrument and then effective per annually thereafter. The fees may be adjusted after January 1 of the year immediately following the conveyance of the Lot to an Owner. The sole intent and purpose of these fees are for operation, maintenance, and improvements of the green space, street lights and other amenities in a manner determined by the association membership.

SECTION 4: Notice and Quorum for Any Action Authorized Under Section 3: Written Notice of any meeting called for the purpose of taking any action authorized under Section 3 shall be sent to all members not less than 10 days in advance of the meeting. At the first such meeting called, the presence of member or proxies entitled to cast 60% of all votes shall constitute a quorum. If the required quorum is not present, another meeting may be called subject to the same notice requirement, and the required quorum at the preceding meeting shall be one-half (1/2) of the required quorum at the preceding meeting. No such subsequent meeting shall be held more than 60 days following the preceding meeting. Each tract as conveyed by Declarant shall have one vote.

SECTION 5: Uniform Rate of Assessment: Both annual and special assessments must be fixed at a uniform rate and may be collect on a semi-annual or annual basis.

SECTION 6: Date of Commencement of Annual Assessments: Due Dates: The annual assessments provided for herein shall commence as to all Lots on the first day of January following the date of recordation of this instrument. The Board of Directors shall fix the amount of the annual assessment against each Lot at least thirty (30) day in advance of each annual assessment period. Written notice of the annual assessment shall be sent to every Owner subject thereto. The due date shall be established by the Board of Directors. The Association shall, upon demand, and for a reasonable charge, furnish a certificate signed by an officer of the Association setting forth whether the assessments on a specified Lot have been paid. A properly executed certificate of the Association as to the status of assessments on a Lot is binding upon the Association as of the date of its issuance.

SECTION 7: Effect of Nonpayment of Assessments: Remedies of the Association: Any assessment not paid within thirty (30) days after the due date shall bear interest from the due date at the rate of ten percent per annum. The Association may bring an action at law against the owner personally obligated to pay the same, or foreclose the lien against the property. No owner may waive or otherwise escape liability for the assessments provided for herein by non-use of the common area or abandonment of the property.

SECTION 8: Subordination of the Lien to Mortgages: The lien of the assessments provided for herein shall be subordinate to the lien of any first mortgage. Sale or transfer of any tract shall not affect the assessment lien. However, the sale or transfer of any tract pursuant to

mortgage foreclosure or any proceeding in lieu thereof, shall extinguish the lien of such assessments as to payments which became due prior to such sale or transfer. No sale or transfer shall relieve such tract from liability for any assessments thereafter becoming due or from the lien thereon.

SECTION 9: Special Assessments for Capital Improvements: In addition to the annual assessments authorized above, the members may levy, in any assessment year, a special assessment applicable to that year only for the purpose of defraying, in whole or in part, the cost of any construction, reconstruction, repair or replacement of a capital improvement upon the common areas, provided that such assessment shall have the assent of two-thirds (2/3) of the votes of the members who are voting in person or by proxy at a meeting duly called for this purpose.

PART F. GENERAL PROVISIONS:

F-1 TERM. These covenants are to run with the land and shall be binding on all parties and all persons claiming under them for a period of twenty-five years from the date these covenants are recorded after which time, said covenants shall be automatically extended for successive period of ten years, subject to the express provision that these covenants may be amended at any time after the date of execution hereby by an instrument signed by the members of the Architectural Control Committee and the owner or owners of a majority of the lots herein platted

are recorded after which time, said covenants shall be automatically extended for successive period of ten years, subject to the express provision that these covenants may be amended at any time after the date of execution hereby by an instrument signed by the members of the Architectural Control Committee and the owner or owners of a majority of the lots herein platted.

F-2 ENFORCEMENT. Enforcement shall be by proceedings at law or in equity against any person or persons violating or attempting to violate any covenant either to restrain violations or to recover damages.

F-3 SEVERABILITY Invalidation of any one of these covenants by judgment or court order shall in no way affect any of the other provisions which shall remain in full force and effect.

IN WITNESS WHEREOF, the name of Owner is hereby affixed by its Members this 6th day of Aug., 2020.

THOMAS D.B. COLLINS, LTD

BY: 
Phillip Pengelly

ACKNOWLEDGEMENT

STATE OF ARKANSAS)
)ss
COUNTY OF SALINE)

On this day appeared before me, a Notary Public, Phillip Pengelly, known to me to be the President of THOMAS D.B. COLLINS, LTD. and acknowledged that he was authorized to execute the foregoing on its behalf and that they had executed same for the consideration and purpose therein mentions and set forth.

Witness my hand and seal this 6th day of Aug, 2020.

Notary Public

My Commission Expires: 6-18-2029

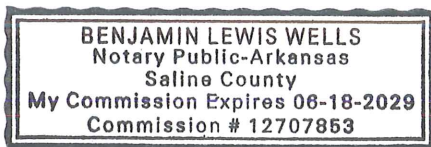

KENSINGTON PLACE PHASE 3

Bryant Planning Commission

Subdivision Checklist

Approved by
Bryant Planning Commission
07/14/2003 Revised 6/18/2007

Instructions

The attached checklist must be completed by the owner and subdivision engineer and must be submitted along with the Preliminary Plat Plan and other specified documentation for review and approval by the Planning Commission. The owner may not begin developing the subdivision until the review of the Preliminary Plat plan is approved.

No changes or alterations can be made to the approved Preliminary Plat Plan without Planning Commission approval.

When all lots have been surveyed, the utilities and drainage measures are in place, and roads have been constructed, the owner and engineer will submit a Final Plat Plan for approval by the Commission. This Final Plat Plan will incorporate all approved changes and will be verified by the City Engineer. No lots will be sold or rights-of-way and easements conveyed until the Final Plat has been submitted and approved.

Fees due to City of Bryant upon submission of Preliminary Plat application

- \$300.00 + \$3.00 per lot - for Subdivision preliminary plat review
- \$250.00 or \$25.00 per lot (**whichever is greater**) - Stormwater Detention and Drainage Plan Engineering Fee
- A Surety Bond or Cashier's check in the amount of 10% of the estimated development cost must be furnished within 10 days after Preliminary Plat approval.

Fees due to Bryant Water and Sewer Department upon submission of Final Plat application

- \$100 per lot - Water/Sewer Impact Fee
- \$100 per Subdivision Phase - Water/Sewer Flushing Fee

Fees due to City of Bryant upon submission of Final Plat application

- \$25.00 + \$1.00 per lot - for Subdivision Final Plat review

City of Bryant Subdivision Checklist

Subdivision/Project Name KENSINGTON PLACE PHASE 3
Contact Person VERNON WILLIAMS Phone (501) 408-4650
Mailing Address 3825 MT CARMEL ROAD, BRYANT, AR
72022

I. BASIC INFORMATION NEEDED ON THE PLAT

- ▲ 1. Name of Subdivision/Project
- ▲ 2. Current zoning R-1.5
- ▲ 3. Name and Address of owner of Record
- ▲ 4. Illustrate Source of Title giving deed record book and page number
- ▲ 5. Name & address of the sub-divider
- ▲ 6. Date of Survey
- ▲ 7. Vicinity map locating streets, highways, section lines, railroad, schools, & parks within ½ mile
- ▲ 8. Legal description of the property with exact boundary lines
- ▲ 9. Acreage of property
- ▲ 10. Number of Lots
- ▲ 11. Lot area in square feet
- ▲ 12. Lot lines with appropriate dimensions
- ▲ 13. Building setback lines
- ▲ 14. Preliminary Engineering certificate seal and signature on each page
- ▲ 15. Certificate of Engineering Accuracy
- ▲ 16. Certificate of Owner
- ▲ 17. Certificate of Final Plat Approval
- ▲ 18. Certificate of Recording
- ▲ 19. Show scale (not less than 1" = 100')
- ▲ 20. North Arrow
- ▲ 21. Show Title block
- ▲ 22. Show adjoining property owners
- ▲ 23. Layout of all proposed streets including traffic control devices (stop signs, speed limit, etc.)
- ▲ 24. Layout of all subdivision entrance street upgrades
- ▲ 25. Layout of all proposed alleys
- ▲ 26. Layout of all proposed sidewalk systems
- ▲ 27. Layout identifies any FEMA flood plain and flood way property within the 100-year flood elevation. (Provide Corp of Engineers 404 Permit if required)
- ▲ 28. Drainage easements for stormwater run-off and detention giving dimensions, locations, and purpose
- ▲ 29. Layout accommodates Master Street Plan segments within the boundaries
- ▲ 30. Street layout ties to existing adjoining subdivision stub-out streets and provides stub-out streets for future adjoining subdivisions.
- ▲ 31. Street width and right-of-way properly shown for each functional classification
- ▲ 32. Street centerlines showing angles of deflection, intersection, radii, length oftangents and arcs, and degree of curvature with basis of curve data
- ▲ 33. Typical cross section of streets
- ▲ 34. Location and name of existing streets
- ▲ 35. New street names that are not similar to existing street names
- ▲ 36. Show street lights
- ▲ 37. Show Fire Hydrant placement

- ▲ 38. Show and label all permanent & proposed easements
- ▲ 39. Any proposed open space must be shown
- ▲ 40. Show the direction and flow of all water courses entering the tract
- ▲ 41. Show the direction and flow of all water courses leaving the tract
- ▲ 42. The drainage area of all water courses above the points of entry.
- ▲ 43. The downstream drainage channel and drainage structures substantially impacted by the subdivision/project.
- ▲ 44. Show source of water supply
- ▲ 45. Show location of waste water connection to municipal main & sanitary sewer layout
- ▲ 46. A phasing plan outlining the boundaries for each phase

II. ADDITIONAL INFORMATION NEEDED, BUT NOT NECESSARILY ON THE PLAT

- ▲ 47. Natural features within the proposed subdivision including drainage channels, bodies of water, wooded areas, and other significant features
- ▲ 48. Existing streets, buildings, water courses, railroads. Culverts, utilities and easement on and adjacent to the tract.
- ▲ 49. Where method of disposal of wastewater is other than connection to a public waste water system, detailed information shall accompany the plat.
- ▲ 50. Calculations and field notes, including drainage calculations along with support drawing
 - 51. Stormwater detention plan approval from City Engineer (attach copy of approval)
- ▲ 52. The Certificate of Preliminary Engineering Accuracy on each set of street and drainage plans.
- ▲ 53. ADA Accessibility Standard Form completed (and attached)
- ▲ 54. A Bill of Assurance has been prepared for this subdivision (and attached)
- ▲ 55. All lots comply with minimum square footage area and minimum lot width at the front building line
- ▲ 56. Street pavement design will be as specified by City or AHTD design procedures, approved by the City Engineer.
- ▲ 57. Made the "One Call" prior to site clearance or other excavation activity

III. PRELIMINARY PLAT ATTACHMENTS

(APPLICATION WILL NOT BE ACCEPTED UNTIL ALL ATTACHMENT REQUIREMENTS ARE MET)

- ▲ 58. Letter to Planning Commission stating your request
- ▲ 59. Completed Checklist
- ▲ 60. Completed agreement to provide performance assurance
- ▲ 61. Subdivider Performance Bond or Cashier's Check for infrastructure installation
- ▲ 62. Landscaping plan of any proposed common open space
- ▲ 63. Draft of Bill of Assurance proposed for the subdivision (if applicable)
- ▲ 64. 20 copies of Preliminary Plat Plan (folded) that includes vicinity map (minimum size 17" X 34" paper)
- ▲ 65. Two (2) IBM compatible diskettes or CDR's with pertinent data and Plat in CAD compatible .DXF electronic file format
- ▲ 66. Copy of Stormwater Detention approval
- ▲ 67. 2 copies Plan and profile of all streets
- ▲ 68. Receipt for \$300.00 + \$3.00 per lot for preliminary Subdivision fee
- ▲ 69. Receipt for \$250.00 or \$25.00 per lot (whichever is greater) for Stormwater Detention and Drainage Plan review
- ▲ 70. Copy of ADEQ Stormwater Pollution Prevention Plan for property parcel containing one acre or larger.

III. FINAL PLAT ATTACHMENTS

(APPLICATION WILL NOT BE ACCEPTED UNTIL ALL ATTACHMENT REQUIREMENTS ARE MET)

- ▲ 71. Letter to Planning Commission stating your request
- ▲ 72. Completed Checklist
- ▲ 73. 20 copies of Final Plat Plan (folded) that includes vicinity map (minimum size 17" X 34" paper)
- ▲ 74. Two (2) IBM compatible diskettes or CDR's with pertinent data and Plat in CAD compatible .DXF electronic file format
- ▲ 75. Bill of Assurance including provisions set out in Title 15 Subdivision Regulations 15.16.01
- ▲ 76. Copy of Water & Sewer Commission approval or....
- ▲ 77. State Health Department approval of any new water supply and/or sewage system.
- ▲ 78. Letter submitted by a Registered Professional Engineer, certifying that all infrastructure improvements and installations have been installed in accordance with the submitted construction plans and drawings and the standards established by the City of Bryant and are functioning properly.
- ▲ 79. Infrastructure Maintenance Bond or Cashier's check.
- ▲ 80. Check for \$25.00 + \$1.00 per lot for final Subdivision fee
- ▲ 81. Check for Water Sewer impact fees (\$100.00 Flushing Fee and \$100.00 impact fee per lot)

KENSINGTON PLACE PHASE 3

Name of Subdivision

Surveyor

I HAVE COMPLIED WITH THE REQUIREMENTS LISTED ABOVE AND HAVE CHECKED ALL OF THE BOXES ON THE CHECKLIST WHICH APPLY TO THIS PROJECT SUBMITTAL.

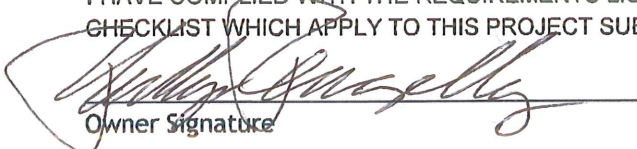
Owner Signature

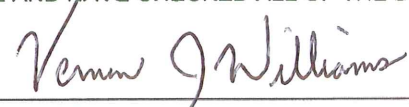
Engineer Signature

CITY USE

Preliminary Plat Approved _____

Planning Commission Date _____

Final Plat Approved _____

Planning Commission Date _____

Proof of Recording - County _____

County Clerk _____

Date _____



3825 Mt Carmel Rd.
Bryant, AR 72022

GarNat Engineering, LLC

P.O. Box 116
Benton, AR 72018

November 14, 2023

Truett Smith
Planning & Community Development
210 S.W. 3rd Street
Bryant, AR 72022

Re: Final Plat Certification
Kensington Place Subdivision Phase 3

Dear Mr. Smith:

Please allow this letter to serve as the certification for the referenced project required by Paragraph 15.12.05.a of the City of Bryant Subdivision Regulations. To that end, we certify that all improvements and installation to the subdivision required for its approval under the terms of the City of Bryant Subdivision Rules and Regulations have been made, added, or installed. Furthermore, these improvements were constructed in accordance with the approved plans and specifications.

If you have questions or need any additional information, please do not hesitate to contact us.

Sincerely,
GarNat Engineering, LLC

Vernon J. Williams, P.E., President

Thomas D.B. Collins

Phillip Pengelly

GNE

3825 Mt Carmel Rd.
Bryant, AR 72022

GarNat Engineering, LLC

P.O. Box 116
Benton, AR 72018

January 2, 2024

Mr. Truett Smith
Bryant Planning Coordinator/Planning Commission Secretary
210 SW 3rd Street
Bryant, AR 72022

Re: Final Plat – Kensington Place Subdivision, Phase 3

Dear Mr. Smith:

Please allow this letter and following list of enclosures to serve as my application for approval of the referenced final plat. It is my desire that this matter be included on the agenda for your February 12, 2024 City of Bryant Planning Commission meeting. The developer for the project is Thomas D.B. Collins, Ltd, 9360 Gilbert Road, Benton, Arkansas, 72019 owencreek@comcast.net (501) 680-0970.

List of Enclosures

- Final Plat
- As Builts
- Bryant Subdivision Checklist
- Certification letter signed by developer and professional engineer

If you have questions or need any additional information, please do not hesitate to contact me.

Sincerely,
GarNat Engineering, LLC

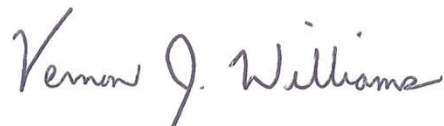

Vernon J. Williams, P.E., President



PHILLIP LEWIS ENGINEERING

Structural + Civil Consultants

23620 Interstate 30 | Bryant, AR
PH: 501-350-9840

December 10, 2023

Truett Smith
Community Development
Community development Director
tsmith@cityofbryant.com

RE: SUMMERWOOD SPORTS GYM #3 REVISED SITE PLAN

To whom it may concern:

Please find below our responses to each planning/engineering review comment. Design plans with comments attached have been revised and re-submitted along with this letter.

Review Comments:

1. 2" meter service to be installed in green space not in asphalt.
 - Revised meter setting location to be installed in island.
2. Field verify location and depth of existing 8" water main running east and west and add to plans
 - Added existing 8" water main location to plans.
3. Possible conflict with dumpster pad area and existing 8" water main.
 - After verifying location of existing 8" water main, the dumpster pad doesn't conflict with water main.
4. How is existing pond to be re-established.
 - The rim elevations will be brought back up to 400' elevation. The bottom of the pond will be re-graded. A trickle channel will be added to allow all the water to reach the outlet structure.
5. Possible conflict with exiting 8" water main.
 - The storm pipe is existing pipe ran from the past project. We are dropping new inlets to the existing pipe.
6. Fire line to remain private from demarcation valve and to be 8" ductile iron per specification 1100-1-1.03 and 1100-2-1.05.
 - Added demarcation valve and 8" DI pipe to plans.
7. Will this sidewalk have an ADA ramp to allow access through parking lot and into building?
 - Yes, this will have an ADA ramp to allow access. Shown on plans.
8. Submit drainage calculations for pond.
 - Please see the attached stormwater drainage report attached with this letter.
9. Saw cut, match existing elevation and grade, and provide smooth transition???
 - Added notes to plans.
10. Street Name???
 - Added street name to plans.

11. How is pedestrian trail transitioned into drive?
 - The drive will come up to the existing pedestrian trail and match elevations. Detailed on plans.
12. Show that grades are to meet ADA requirements.
 - Added slope to plans.
13. Transition to handicap access?
 - The parking spaces will be flush with the sidewalk. No curb will be installed at this location.
14. Submit drainage calculations for site which meet City of Bryant stormwater requirements.
 - Please see the attached stormwater drainage report attached with this letter.
15. Provide calculations for depth of flow in parking spaces.
 - Please see the attached stormwater drainage report attached with this letter.
16. How is water managed at this low point?
 - Adjusted gutter elevations so water will flow east from this point.
17. Demonstrate that existing pond has a sufficient outfall control structure to meet the city requirements for detention ponds.
 - Please see the attached stormwater drainage report attached with this letter.
18. How is the stormwater managed in this area?
 - This will bypass the pond. Rip rap will be installed at end of road for erosion control.
19. How is this graded? This water does not appear to go to the detention pond.
 - This will bypass the pond.
20. Verify grades here. Is this a discharge point? If so, submit drainage calculations to demonstrate that this opening is sufficient for new design flows.
 - This will be a discharge point. This will also bypass the pond.
21. Provide stormwater calculations which reflect capacity and also hydraulic grade of stormwater through boxes and pipes.
 - Please see the attached stormwater drainage report attached with this letter.
22. Show inlet calculations.
 - Please see the attached stormwater drainage report attached with this letter.
23. Fire hydrants not listed on plans. FDC shall be equipped with 5" storz connection. fire hydrant shall be within 100' of FDC.
 - Added fire hydrant to plans.
24. Where is this pipe going to?
 - This pipe is going to the detention pond.
25. Show drainage arrows in direction of flow.
 - Added to plans.
26. Are there roof drains? Where do they discharge?
 - Yes, there will be roof drains on the back of the building. These will be collected in a 12" HDPE pipe and discharged into the detention pond.

27. Please clarify how the drainage basins were determined.

- Drainage basins have been revised after field verifying the grades. The existing southwest building, the west half of the building water shed is flowing into the storm sewer that leads to the larger pond on the northwest of the property. A portion of both buildings water shed is flowing into the existing storm water pipe that we are using to tie-in the new area inlets. The existing southeast building, the east half of the building water shed ultimately flows to the curb cut by the new dumpster pad. Drainage Basin D3 is collected by the area inlet A2 by the ADA parking spaces. Drainage Basin D4 is collected by the area inlet A3. Drainage Basin D5 is collected by the 4'-0" flume that leads into the detention pond. Drainage Basin D6 is collected by downspouts leading into the detention pond. Drainage Basin D7 is bypassing the pond.

28. Are the arrows based upon the proposed or existing grades?

- These arrows are based on existing grades.

If you have any questions, please give me a call.

Sincerely,

Phillip Lewis, P.E.

501-350-9840

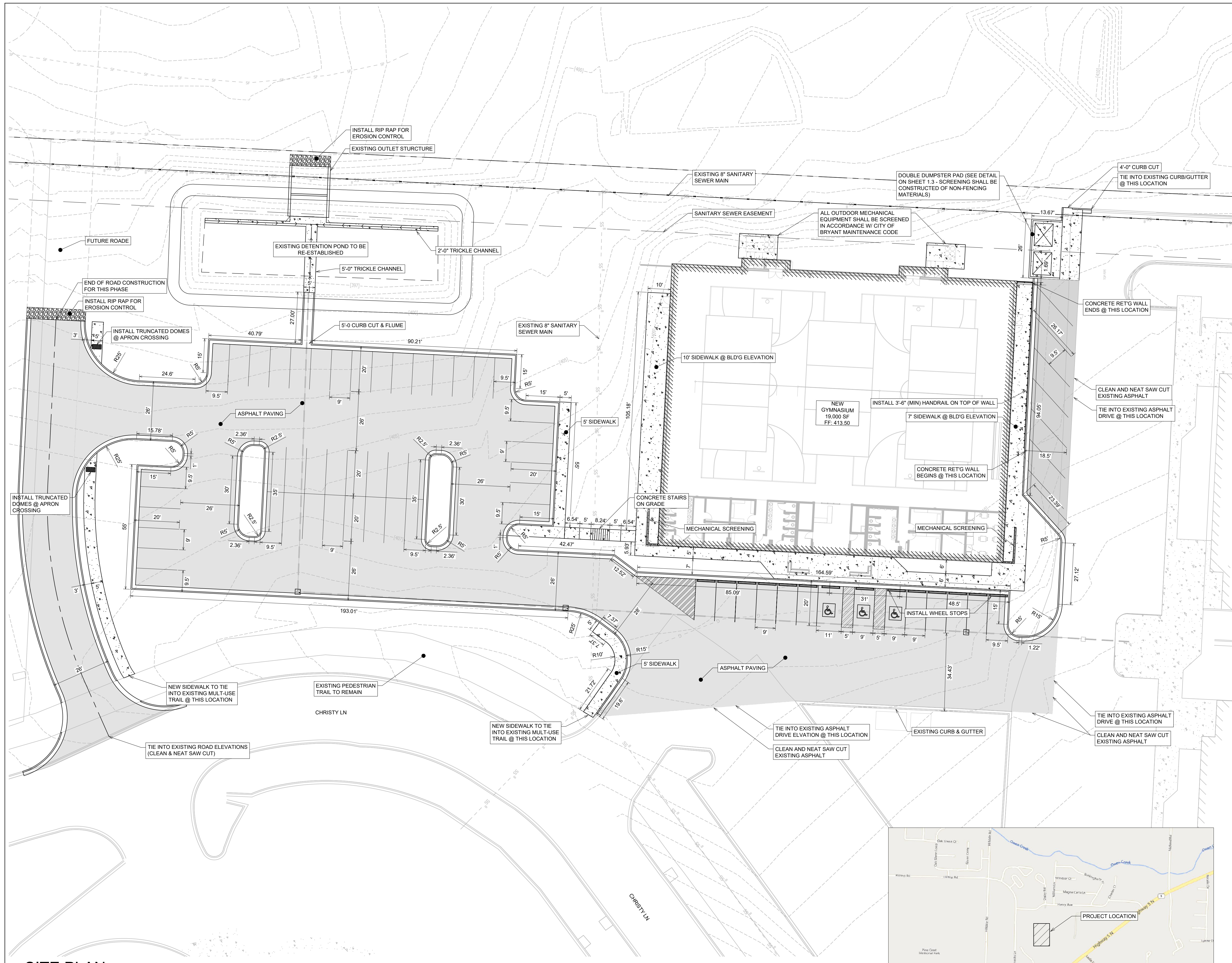

GENERAL CONSTRUCTION NOTES

- A. THE CONTRACTOR WILL BE HELD SOLELY RESPONSIBLE FOR DAMAGES OCCURRING TO ANY PROPERTY DURING THE CONSTRUCTION OF THIS PROJECT. SAID CONTRACTOR SHALL TAKE ALL NECESSARY PRECAUTIONS TO PREVENT PROPERTY DAMAGE.
- B. IN ACCORDANCE WITH GENERALLY ACCEPTED CONSTRUCTION PRACTICES, THE CONTRACTOR WILL SOLELY AND COMPLETELY BE RESPONSIBLE FOR CONDITIONS OF THE JOB SITE, INCLUDING SAFETY WORK. THIS REQUIREMENT WILL APPLY CONTINUOUSLY AND WILL NOT BE LIMITED TO NORMAL WORKING HOURS.
- C. THE DUTY OF BRYANT UTILITIES TO CONDUCT CONSTRUCTION INSPECTION REVIEWS OF THE CONTRACTOR'S PERFORMANCE IS NOT AN INSPECTION OR REVIEW OF THE ADEQUACY OF THE CONTRACTOR'S SAFETY MEASURES IN, ON, OR NEAR THE CONSTRUCTION SITE.
- D. ALL WATER AND SEWER IMPROVEMENTS SHALL BE CONSTRUCTED IN ACCORDANCE WITH THE LATEST REVISION TO THE CITY OF BRYANT'S WATER AND WASTEWATER (SANITARY SEWER) STANDARD SPECIFICATIONS.
- E. THE CONTRACTOR IS SPECIFICALLY CAUTIONED THAT THE LOCATION AND/OR ELEVATION OF EXISTING UTILITIES AS SHOWN ON THESE PLANS IS BASED ON RECORDS OF THE VARIOUS UTILITY COMPANIES AND, WHERE POSSIBLE, MEASUREMENTS TAKEN IN THE FIELD. THE INFORMATION IS NOT TO BE RELIED ON AS BEING EXACT OR COMPLETE. THE CONTRACTOR MUST CALL THE APPROPRIATE UTILITY COMPANY AT LEAST 48 HOURS BEFORE ANY EXCAVATION TO REQUEST EXACT FIELD LOCATION OF ALL UTILITIES. IT SHALL BE THE RESPONSIBILITY OF THE CONTRACTOR TO LOCATE ALL EXISTING UTILITIES WHICH CONFLICT WITH PROPOSED IMPROVEMENTS SHOWN ON THE PLAN.
- F. CONTRACTOR IS TO REMOVE AND DISPOSE OF ALL DEBRIS, RUBBISH, AND OTHER MATERIALS RESULTING FROM PREVIOUS AND CURRENT DEMOLITION OPERATIONS. DISPOSAL WILL BE IN ACCORDANCE WITH ALL LOCAL, STATE AND/OR FEDERAL REGULATIONS GOVERNING SUCH OPERATIONS.
- G. PRIOR TO INSTALLATION OF ANY UTILITIES, THE CONTRACTOR IS TO EXCAVATE, VERIFY AND CALCULATE ALL CROSSINGS AND INFORM ANY AND ALL UTILITIES OF ANY CONFLICTS PRIOR TO CONSTRUCTION.
- H. CONSTRUCTION SHALL NOT START ON ANY WATER UTILITY TIE-INS UNTIL APPROVAL IS GIVEN BY BRYANT UTILITIES. SAID CONTRACTOR SHALL NOT OPERATE ANY VALVE, HYDRANT, OR WATER UTILITY APPURTENANCE NOR SHALL HE ATTACH TO OR TAP ANY WATER UTILITY MAIN WITHOUT APPROVAL. THE CONTRACTOR SHALL BEAR THE COST AND CONSEQUENCE OF ANY DISRUPTION OF UTILITY OPERATION CAUSED BY CONSTRUCTION.
- I. FIBER OPTIC CABLE ON AND/OR ADJACENT TO THIS SITE WERE NOT LOCATED BY THE SURVEY AND ARE NOT SHOWN. IT IS THE RESPONSIBILITY OF THE CONTRACTOR TO LOCATE ANY FIBER OPTIC CABLES ASSOCIATED WITH THIS SITE AND TAKE ALL NECESSARY AND REQUIRED PRECAUTIONS TO PROTECT ANY EXISTING FIBER OPTIC CABLES. CONTRACTORS SHALL COORDINATE ALL EFFORTS WITH OWNER OF FIBER OPTIC CABLES OR THEIR DESIGNATED REPRESENTATIVE.
- J. THE CONTRACTOR IS RESPONSIBLE FOR CONTACTING "ONECALL" SERVICE TO MARK ALL UTILITIES PRIOR TO ANY DEMOLITION, EARTHWORK, OR UTILITY WORK ON THIS SITE.

SITE PLAN

1. 64 PARKING SPACES PROVIDED INCLUDING 3 ADA ACCESSIBLE PARKING SPACES
2. ALL DIMENSIONS ARE TO THE BACK OF CURB AND/OR EDGE OF PAVEMENT
3. DAMAGE TO PUBLIC AND PRIVATE PROPERTY DUE TO HAULING OPERATIONS OR OPERATIONS OF CONSTRUCTION RELATED EQUIPMENT FROM A CONSTRUCTION SITE SHALL BE REPAIRED BY THE RESPONSIBLE PARTY PRIOR TO THE ISSUANCE OF A CERTIFICATE OF OCCUPANCY.
4. REPAIR, REPLACE, OR EXTEND EXISTING DAMAGED OR MISSING CURB AND GUTTER, SIDEWALK OR RAMPS WITHIN THE PUBLIC RIGHT OF WAY.
5. ALL SIGNAGE, PAVEMENT MARKING AND PARKING LOT STRIPING SHALL CONFORM TO REQUIREMENTS GIVEN IN MANUAL OF UNIFORM TRAFFIC CONTROL DEVICES (MUTCD). MUTCD REQUIRES THAT PARKING SPACES BE MARKED IN WHITE.

SCALE 1" = 20'

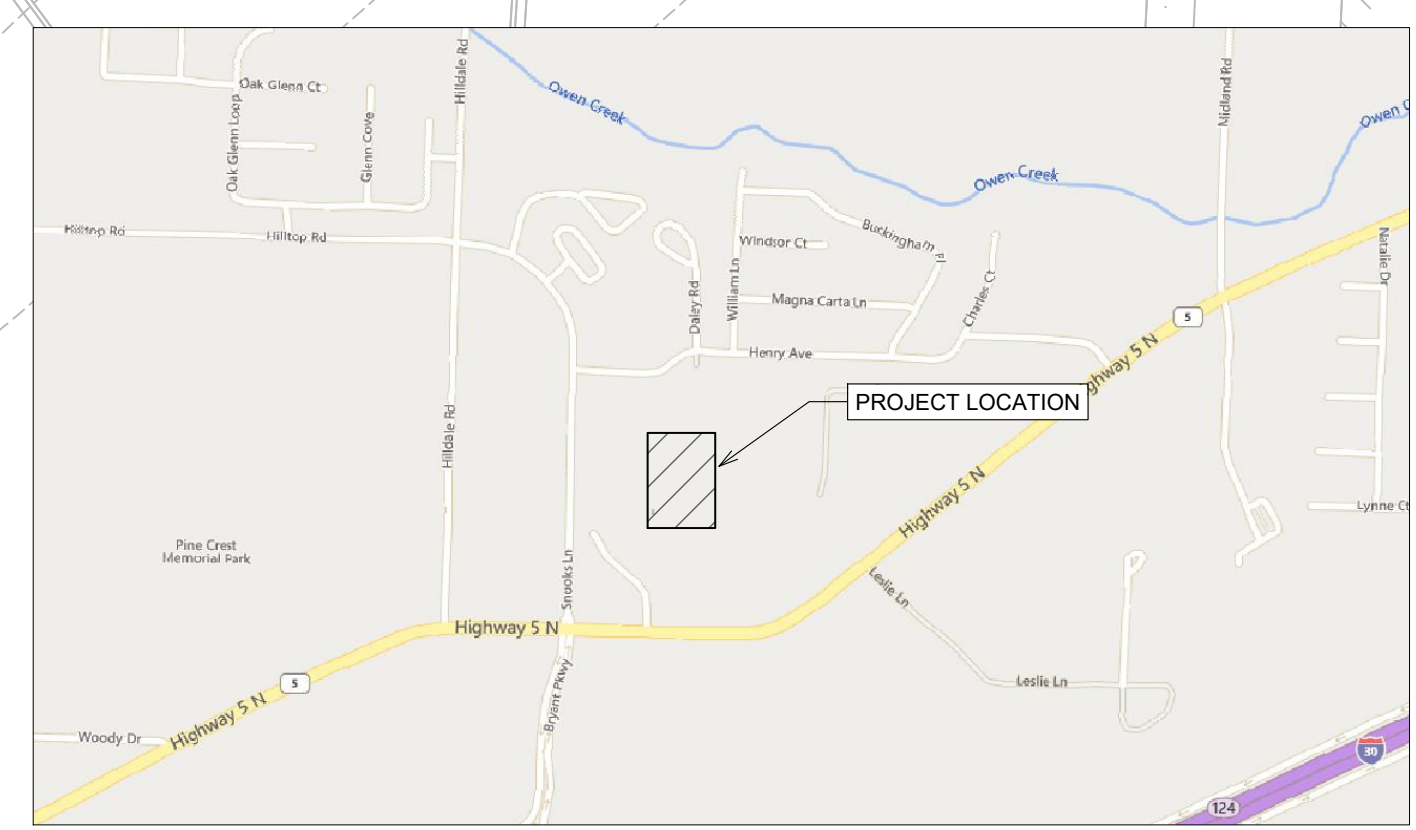

VICINITY MAP
SCALE 1" = 1000'

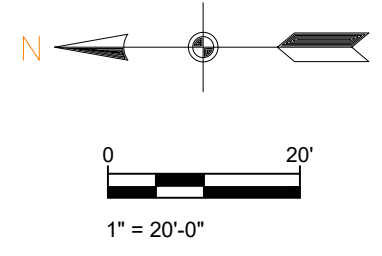

PHILLIP LEWIS ENGINEERING, INC.
Structural + Civil Consultants
23620 Interstate 30 | Bryant, Arkansas
PH: 501-350-9840

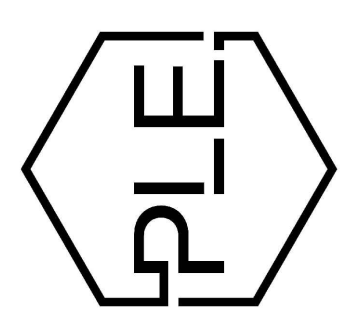

REVISION:

SUMMERWOOD SPORTS GYMNASIUM #3
7817 Hwy 5 N
Bryant, Arkansas

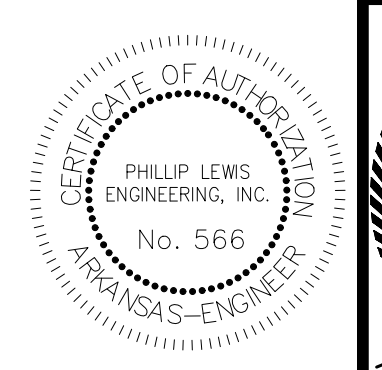

PROJECT NUMBER:
SHEET ISSUE DATE: 1/10/2024
PAGE TITLE: **SITE PLAN**
SHEET NUMBER: **C1.1**

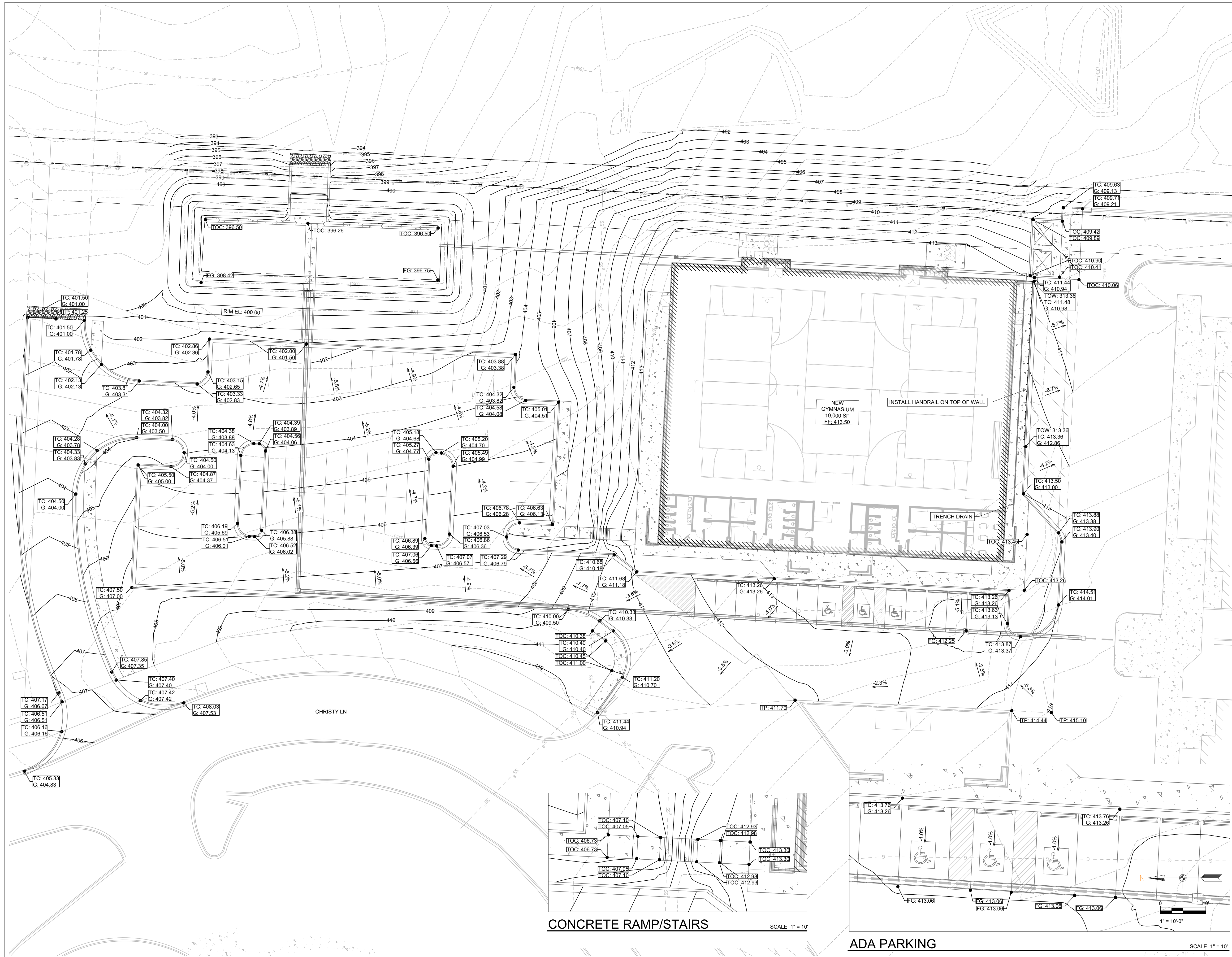

GRADING PLAN

- G = GUTTER ELEVATION
- TP = TOP OF PAVEMENT ELEVATION
- TOC = TOP OF CONCRETE ELEVATION
- FG = FINAL GRADE ELEVATION (NON PAVED AREAS)
- TC = TOP OF CURB ELEVATION
- TOW = TOP OF WALL

SCALE 1" = 20'

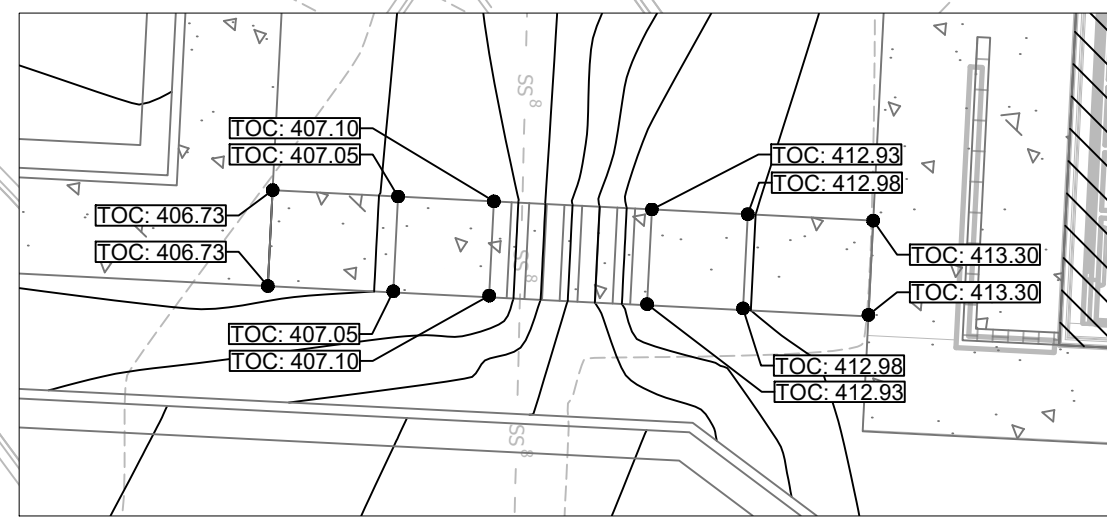

CONCRETE RAMP/STAIRS

SCALE 1" = 10'

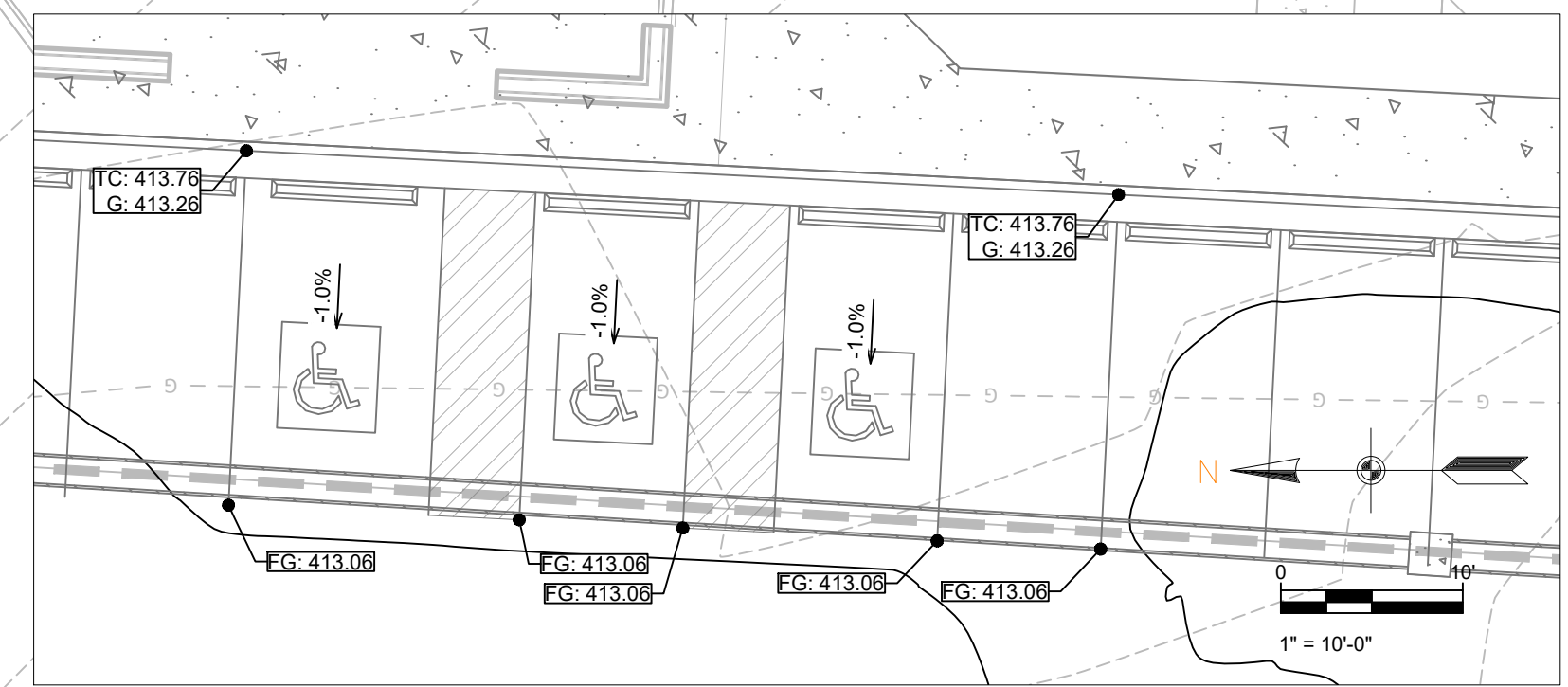

ADA PARKING

SCALE 1" = 10'

GENERAL CONSTRUCTION NOTES

- A. THE CONTRACTOR WILL BE HELD SOLELY RESPONSIBLE FOR DAMAGES OCCURRING TO ANY PROPERTY DURING THE CONSTRUCTION OF THIS PROJECT. SAID CONTRACTOR SHALL TAKE ALL NECESSARY PRECAUTIONS TO PREVENT PROPERTY DAMAGE.
- B. IN ACCORDANCE WITH GENERALLY ACCEPTED CONSTRUCTION PRACTICES, THE CONTRACTOR WILL SOLELY AND COMPLETELY BE RESPONSIBLE FOR CONDITIONS OF THE JOB SITE, INCLUDING SAFETY WORK. THIS REQUIREMENT WILL APPLY CONTINUOUSLY AND WILL NOT BE LIMITED TO NORMAL WORKING HOURS.
- C. THE DUTY OF BRYANT UTILITIES TO CONDUCT CONSTRUCTION INSPECTION REVIEWS OF THE CONTRACTOR'S PERFORMANCE IS NOT AN INSPECTION OR REVIEW OF THE ADEQUACY OF THE CONTRACTOR'S SAFETY MEASURES IN, ON, OR NEAR THE CONSTRUCTION SITE.
- D. ALL WATER AND SEWER IMPROVEMENTS SHALL BE CONSTRUCTED IN ACCORDANCE WITH THE LATEST REVISION TO THE CITY OF BRYANT'S WATER AND WASTEWATER (SANITARY SEWER) STANDARD SPECIFICATIONS.
- E. THE CONTRACTOR IS SPECIFICALLY CAUTIONED THAT THE LOCATION AND/OR ELEVATION OF EXISTING UTILITIES AS SHOWN ON THESE PLANS IS BASED ON RECORDS OF THE VARIOUS UTILITY COMPANIES AND, WHERE POSSIBLE, MEASUREMENTS TAKEN IN THE FIELD. THE INFORMATION IS NOT TO BE RELIED ON AS BEING EXACT OR COMPLETE. THE CONTRACTOR MUST CALL THE APPROPRIATE UTILITY COMPANY AT LEAST 48 HOURS BEFORE ANY EXCAVATION TO REQUEST EXACT FIELD LOCATION OF ALL UTILITIES. IT SHALL BE THE RESPONSIBILITY OF THE CONTRACTOR TO LOCATE ALL EXISTING UTILITIES WHICH CONFLICT WITH PROPOSED IMPROVEMENTS SHOWN ON THE PLAN.
- F. CONTRACTOR IS TO REMOVE AND DISPOSE OF ALL DEBRIS, RUBBISH, AND OTHER MATERIALS RESULTING FROM PREVIOUS AND CURRENT DEMOLITION OPERATIONS. DISPOSAL WILL BE IN ACCORDANCE WITH ALL LOCAL, STATE AND/OR FEDERAL REGULATIONS GOVERNING SUCH OPERATIONS.
- G. PRIOR TO INSTALLATION OF ANY UTILITIES, THE CONTRACTOR IS TO EXCAVATE, VERIFY AND CALCULATE ALL CROSSINGS AND INFORM ANY AND ALL UTILITIES OF ANY CONFLICTS PRIOR TO CONSTRUCTION.
- H. CONSTRUCTION SHALL NOT START ON ANY WATER UTILITY TIE-INS UNTIL APPROVAL IS GIVEN BY BRYANT UTILITIES. SAID CONTRACTOR SHALL NOT OPERATE ANY VALVE, HYDRANT, OR WATER UTILITY APPURTENANCE NOR SHALL HE ATTACH TO OR TAP ANY WATER UTILITY MAIN WITHOUT APPROVAL. THE CONTRACTOR SHALL BEAR THE COST AND CONSEQUENCE OF ANY DISRUPTION OF UTILITY OPERATION CAUSED BY CONSTRUCTION.
- I. FIBER OPTIC CABLE ON AND/OR ADJACENT TO THIS SITE WERE NOT LOCATED BY THE SURVEY AND ARE NOT SHOWN. IT IS THE RESPONSIBILITY OF THE CONTRACTOR TO LOCATE ANY FIBER OPTIC CABLES ASSOCIATED WITH THIS SITE AND TAKE ALL NECESSARY AND REQUIRED PRECAUTIONS TO PROTECT ANY EXISTING FIBER OPTIC CABLES. CONTRACTORS SHALL COORDINATE ALL EFFORTS WITH OWNER OF FIBER OPTIC CABLES OR THEIR DESIGNATED REPRESENTATIVE.
- J. THE CONTRACTOR IS RESPONSIBLE FOR CONTACTING "ONECALL" SERVICE TO MARK ALL UTILITIES PRIOR TO ANY DEMOLITION, EARTHWORK, OR UTILITY WORK ON THIS SITE.

PHILLIP LEWIS ENGINEERING, INC.
Structural + Civil Consultants
23620 Interstate 30 | Bryant, Arkansas
PH: 501-350-9840



REVISION:

SUMMERWOOD SPORTS GYMNASIUM #3
7817 Hwy 5 N
Bryant, Arkansas



PROJECT NUMBER:
SHEET ISSUE DATE: 1/10/2024
PAGE TITLE: GRADING PLAN
SHEET NUMBER: C1.2

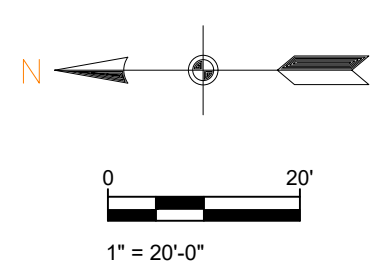

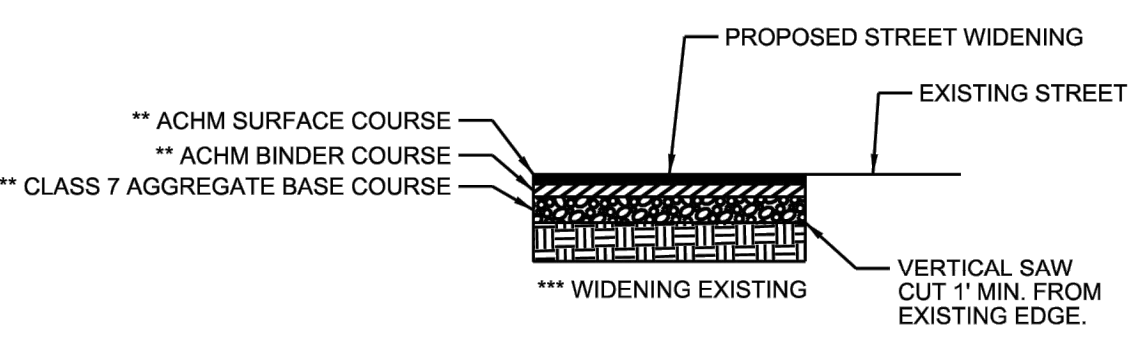
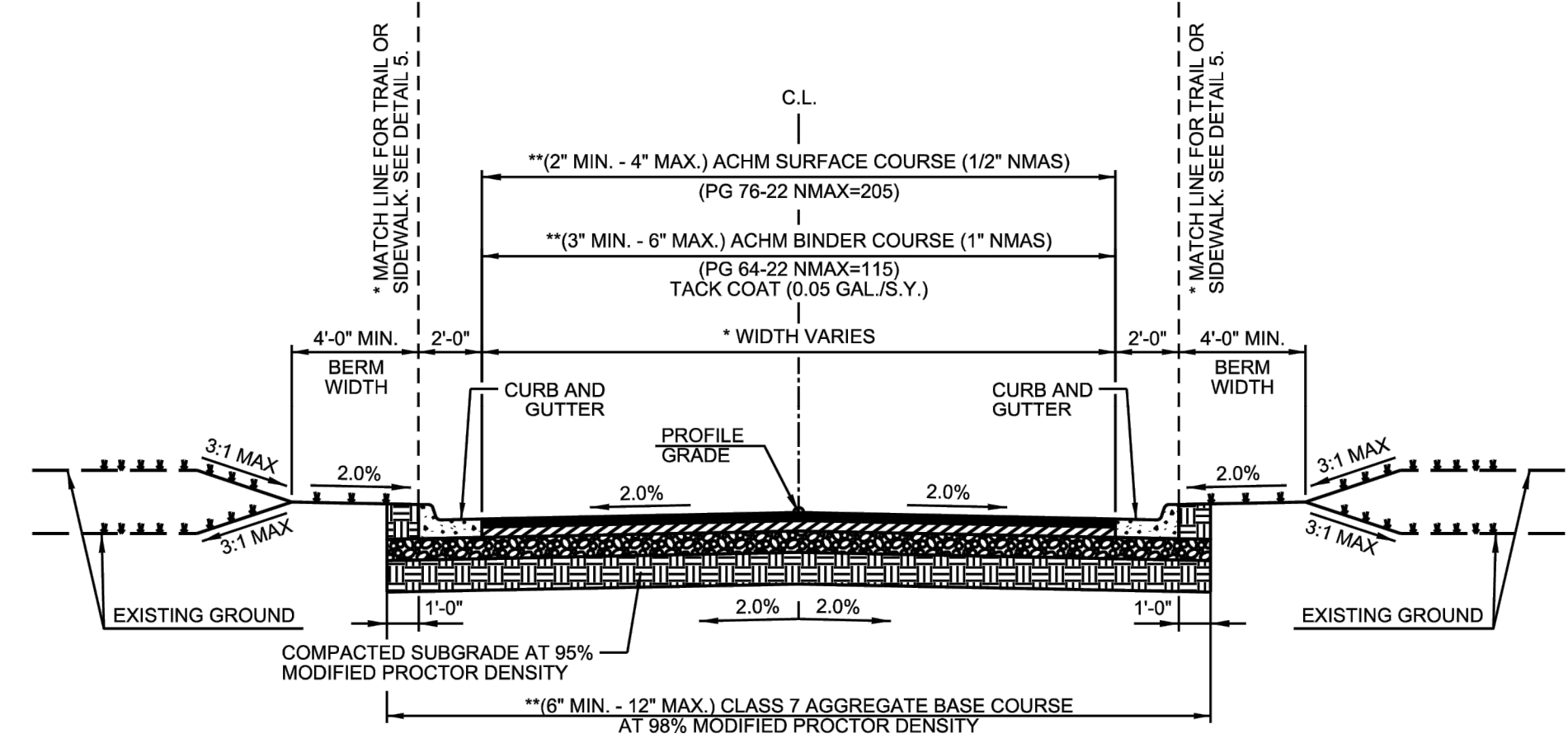

- GENERAL NOTES**
- IN AREAS TO RECEIVE BITUMINOUS PAVING, CONCRETE DRIVEWAYS OR CURB AND GUTTER, SUBGRADE SHALL BE COMPACTED TO A DENSITY NOT LESS THAN 95% OF MAXIMUM MODIFIED DENSITY OBTAINED AT OPTIMUM MOISTURE CONTENT.
 - FOR AREAS OF SUBGRADE PREPARATION TO RECEIVE CONCRETE SIDEWALKS, SUBGRADE SHALL BE COMPACTED TO DENSITY OF 90% MAXIMUM MODIFIED DENSITY.
 - CRUSHED STONE - MATERIAL IN EACH COURSE SHALL BE COMPACTED TO A DENSITY OF 98% MAXIMUM MODIFIED DENSITY.
 - ACHM BASE COURSE (4" MIN. - 12" MAX.) (1 1/2" NMAS) MAY BE USED IF INCLUDED IN AN APPROVED PAVEMENT DESIGN.
- CROSS SECTIONS AND RIGHT-OF-WAY SHALL ADHERE TO THE MINIMUM WIDTH REQUIREMENTS SHOWN IN THE CITY OF BRYANT MASTER TRANSPORTATION PLAN. THE DEVELOPMENT REVIEW COMMITTEE SHALL DETERMINE WHICH VERSION OF STREET CLASSIFICATION AND WHAT WIDTHS WILL BE REQUIRED.**
- THICKNESS TO BE DETERMINED BY PAVEMENT DESIGN IN ACCORDANCE WITH SECTION 5.0 OF THE MINIMUM STANDARD SPECIFICATIONS FOR STREETS.**
- PAVEMENT RECONSTRUCTION TO CENTERLINE IS REQUIRED WHEN EXISTING STREET DOES NOT MEET THESE STANDARDS.**

CITY OF BRYANT

TYPICAL SECTION MINOR ARTERIAL

ISSUE DATE: AUGUST 2021

REVISION DATE:

DETAIL 1

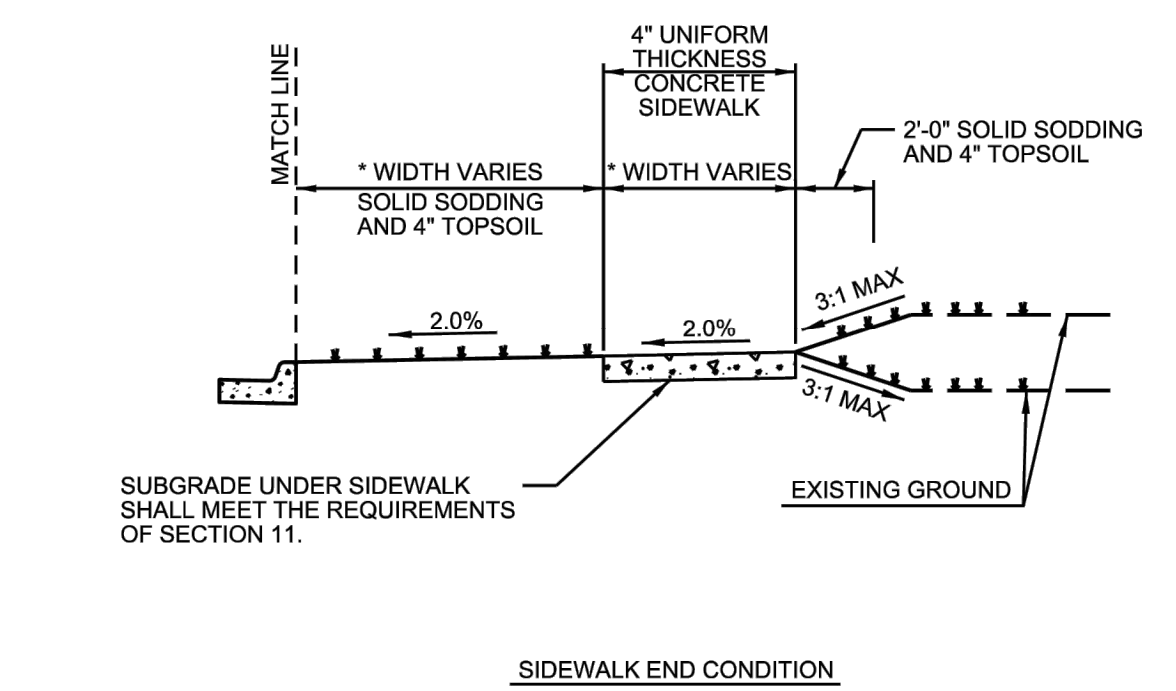
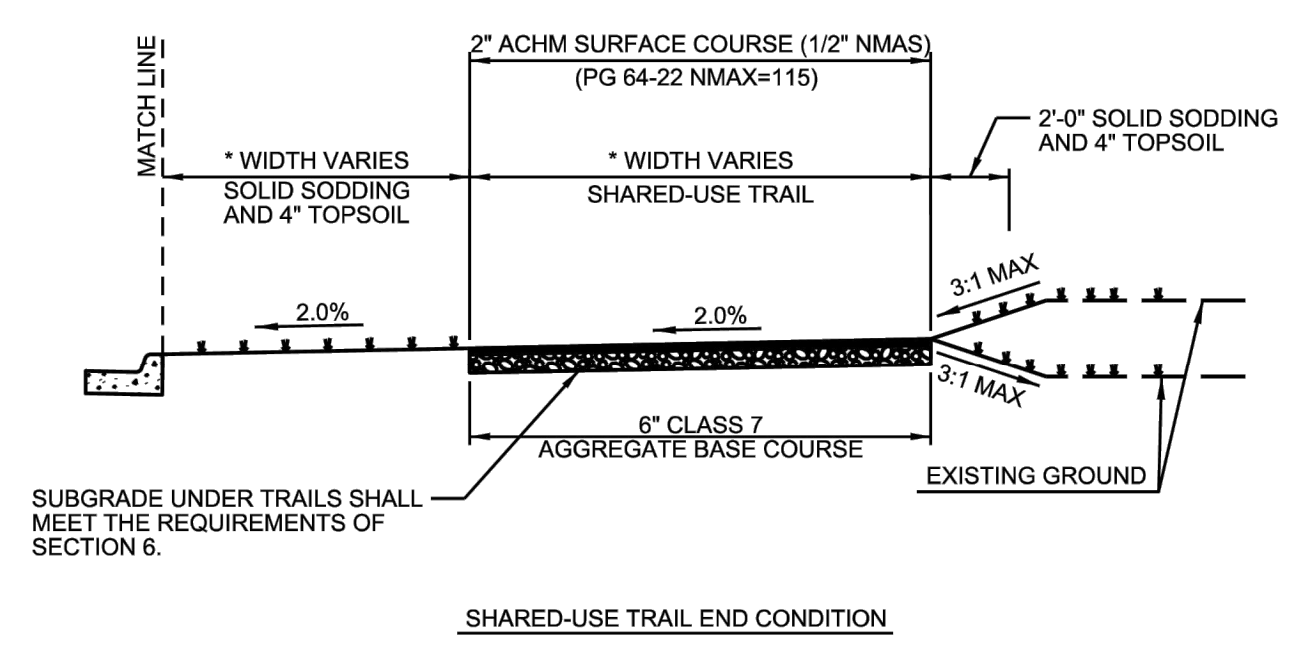

* WIDTH SHALL ADHERE TO THE MINIMUM WIDTH REQUIREMENTS SHOWN IN THE CITY OF BRYANT MASTER TRANSPORTATION PLAN. THE DEVELOPMENT REVIEW COMMITTEE SHALL DETERMINE WHICH VERSION OF STREET CLASSIFICATION AND WHAT WIDTHS WILL BE REQUIRED.

CITY OF BRYANT

TYPICAL SECTION END CONDITIONS

ISSUE DATE: AUGUST 2021

REVISION DATE:

DETAIL 5

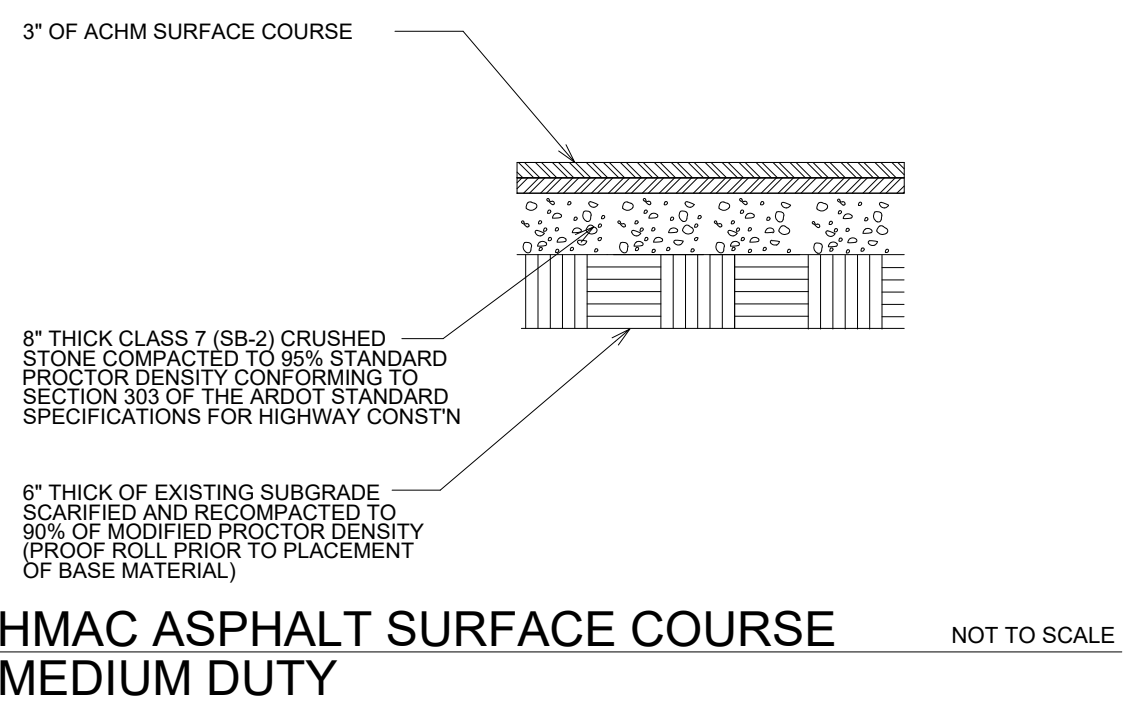

HMAC ASPHALT SURFACE COURSE MEDIUM DUTY NOT TO SCALE

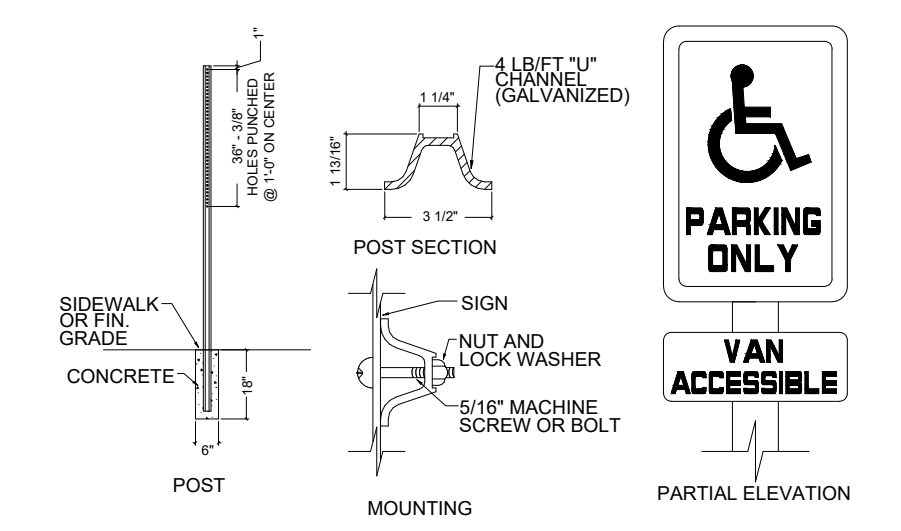

HANDICAP SIGN DETAIL NOT TO SCALE

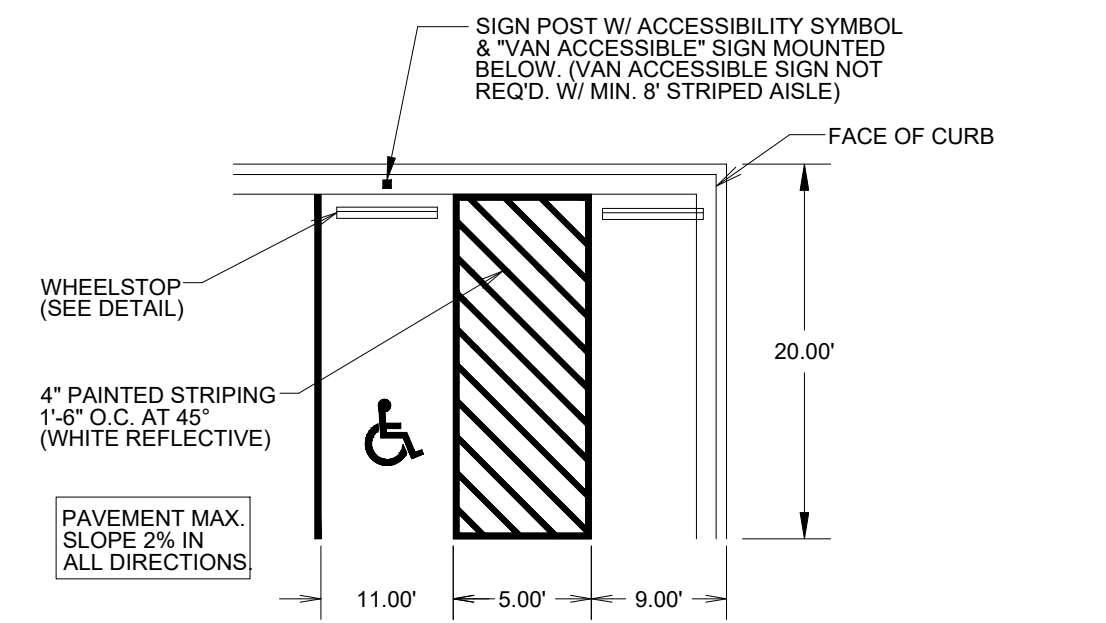

TYPICAL ACCESSIBLE PARKING STALLS

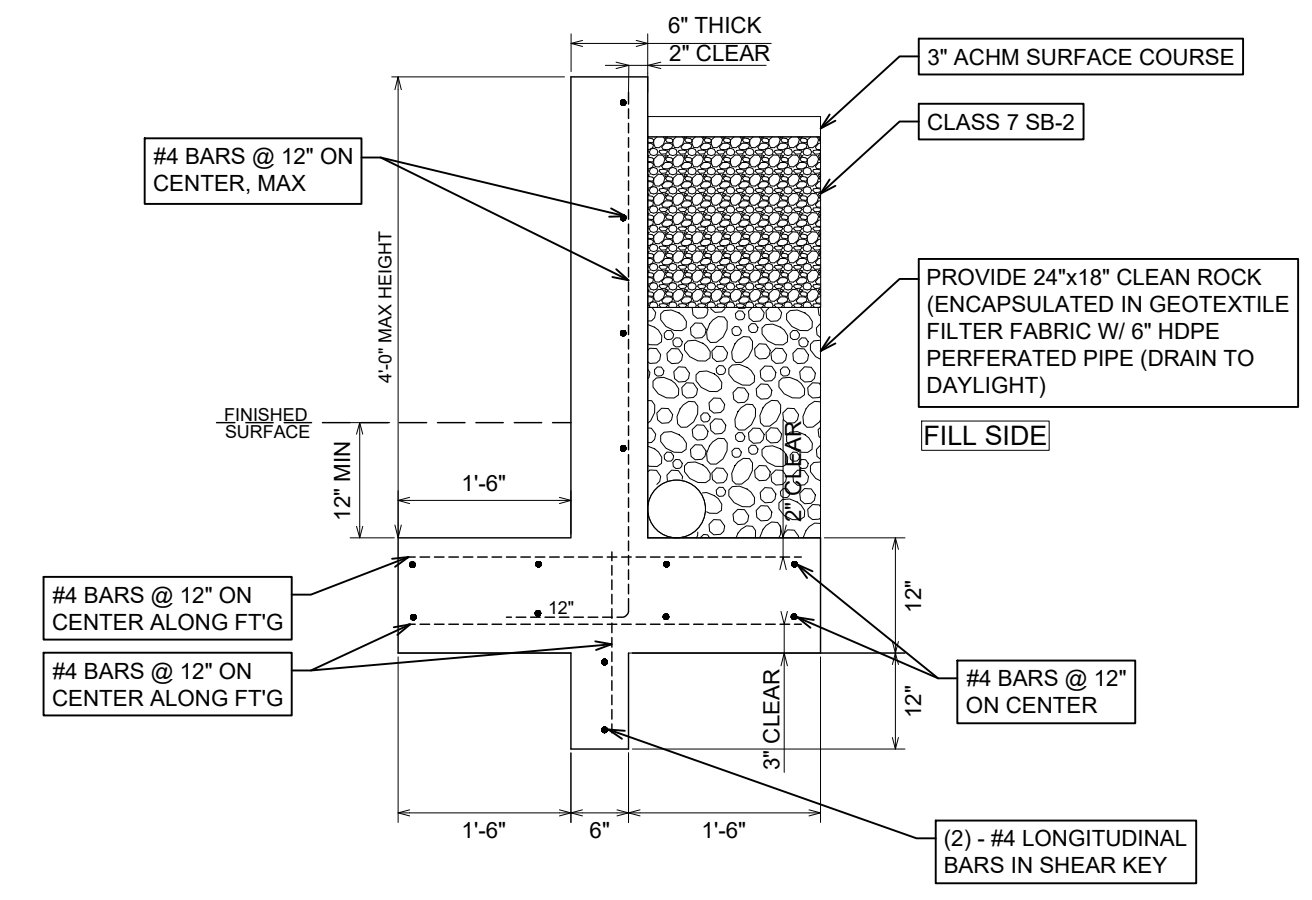

RETAINING WALL NOT TO SCALE

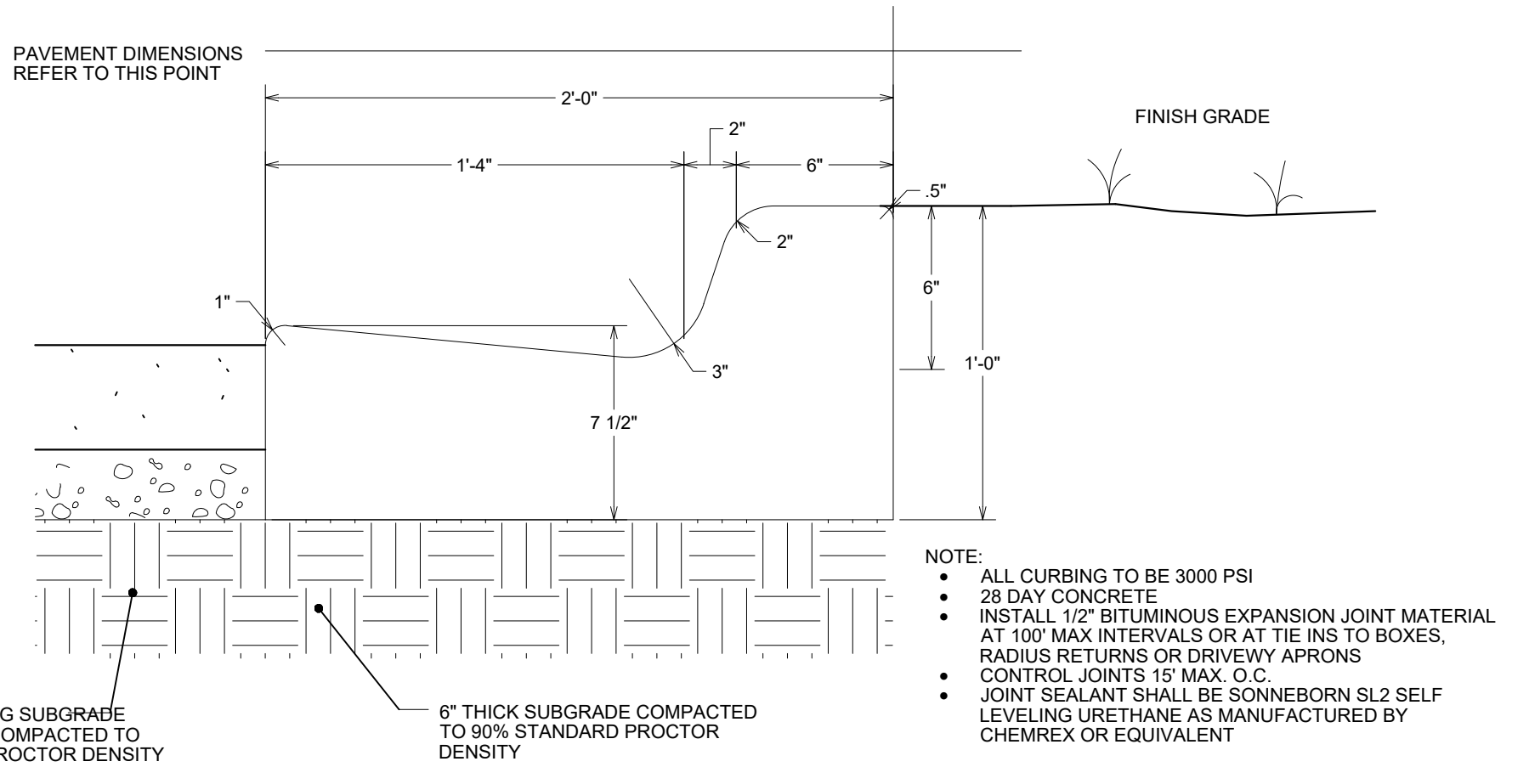

2-0" CONCRETE CURB & GUTTER NOT TO SCALE

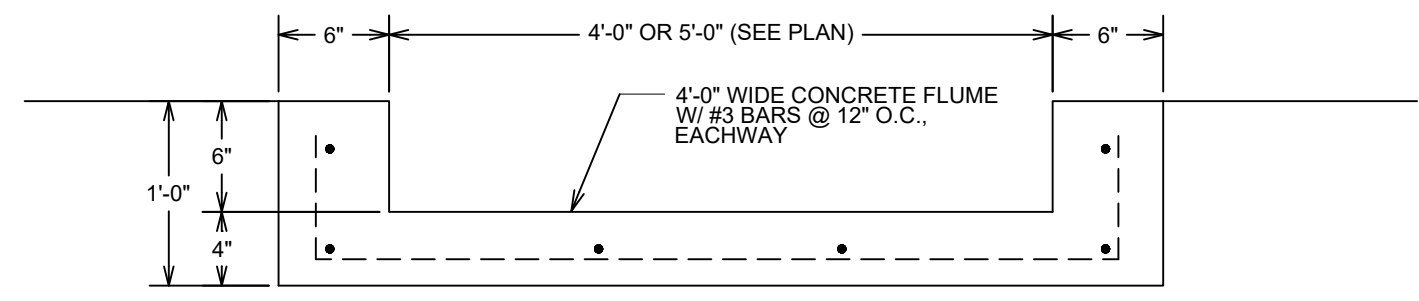

CONCRETE FLUME DETAIL NOT TO SCALE

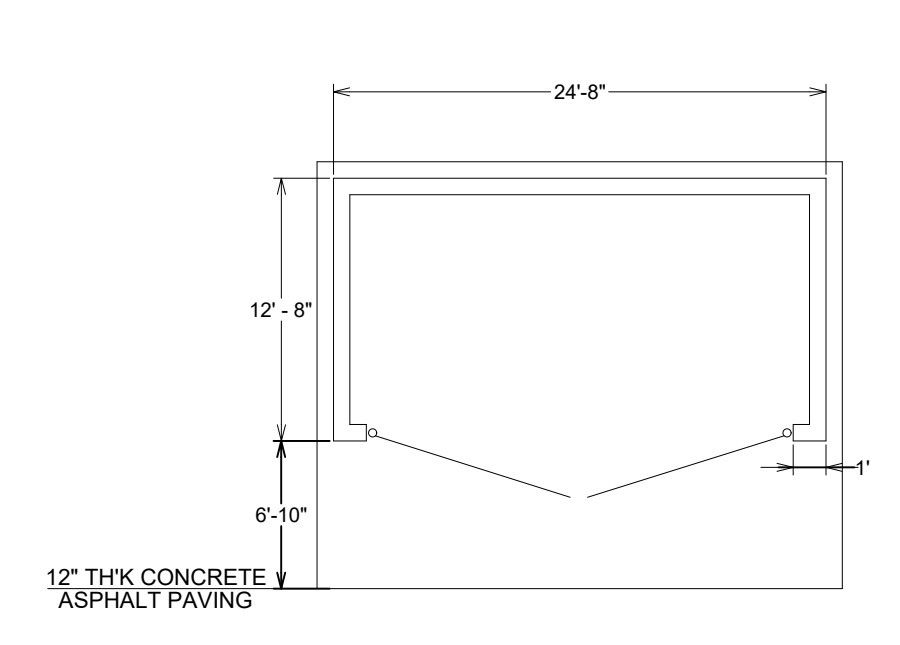

DUMPSTER PAD/ENCLOSURE DETAIL

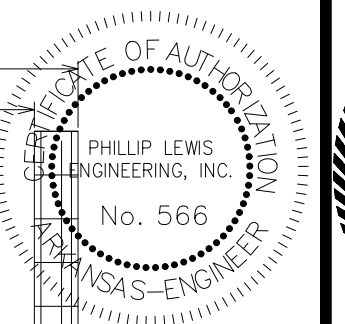
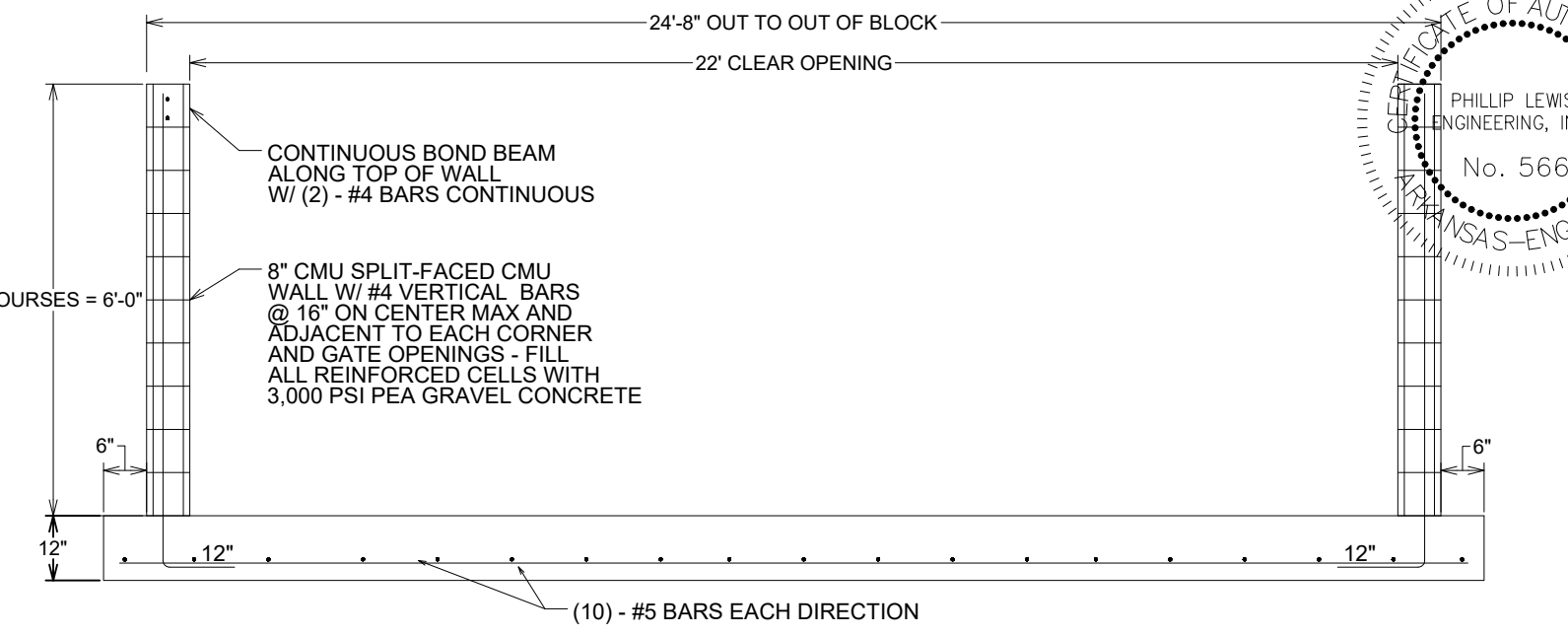

PROJECT NUMBER:

SHEET ISSUE DATE: 1/10/2024

PAGE TITLE: SITE DETAILS

SHEET NUMBER: C1.3

PHILLIP LEWIS ENGINEERING, INC.
Structural + Civil Consultants
23620 Interstate 30 | Bryant, Arkansas
PH: 501-350-9840

PLE

REVISION:

SUMMERWOOD SPORTS GYMNASIUM #3
7817 Hwy 5 N
Bryant, Arkansas

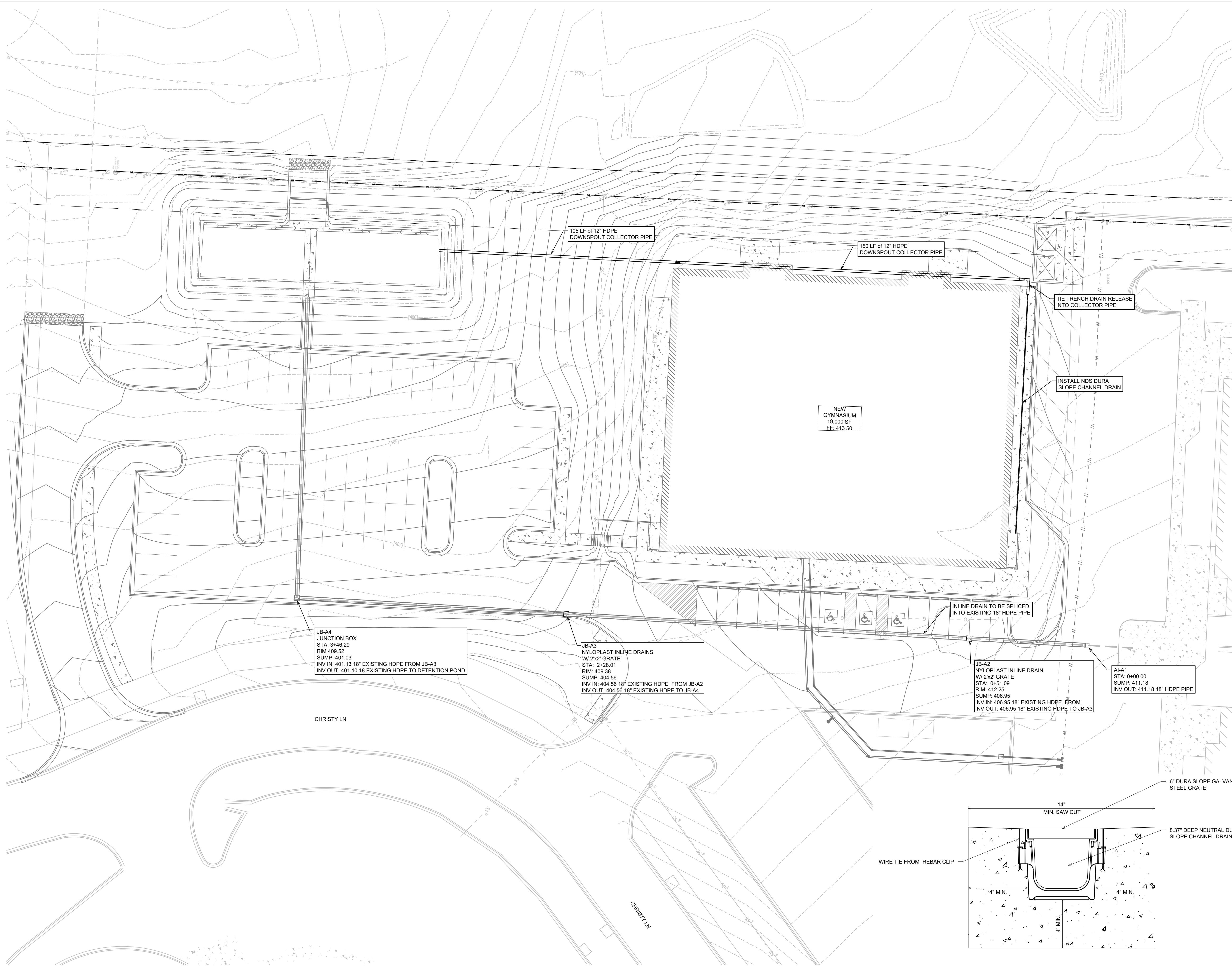

GENERAL CONSTRUCTION NOTES

- A. THE CONTRACTOR WILL BE HELD SOLELY RESPONSIBLE FOR DAMAGES OCCURRING TO ANY PROPERTY DURING THE CONSTRUCTION OF THIS PROJECT. SAID CONTRACTOR SHALL TAKE ALL NECESSARY PRECAUTIONS TO PREVENT PROPERTY DAMAGE.
- B. IN ACCORDANCE WITH GENERALLY ACCEPTED CONSTRUCTION PRACTICES, THE CONTRACTOR WILL SOLELY AND COMPLETELY BE RESPONSIBLE FOR CONDITIONS OF THE JOB SITE, INCLUDING SAFETY WORK. THIS REQUIREMENT WILL APPLY CONTINUOUSLY AND WILL NOT BE LIMITED TO NORMAL WORKING HOURS.
- C. THE DUTY OF BRYANT UTILITIES TO CONDUCT CONSTRUCTION INSPECTION REVIEWS OF THE CONTRACTOR'S PERFORMANCE IS NOT AN INSPECTION OR REVIEW OF THE ADEQUACY OF THE CONTRACTOR'S SAFETY MEASURES IN, ON, OR NEAR THE CONSTRUCTION SITE.
- D. ALL WATER AND SEWER IMPROVEMENTS SHALL BE CONSTRUCTED IN ACCORDANCE WITH THE LATEST REVISION TO THE CITY OF BRYANT'S WATER AND WASTEWATER (SANITARY SEWER) STANDARD SPECIFICATIONS.
- E. THE CONTRACTOR IS SPECIFICALLY CAUTIONED THAT THE LOCATION AND/OR ELEVATION OF EXISTING UTILITIES AS SHOWN ON THESE PLANS IS BASED ON RECORDS OF THE VARIOUS UTILITY COMPANIES AND, WHERE POSSIBLE, MEASUREMENTS TAKEN IN THE FIELD. THE INFORMATION IS NOT TO BE RELIED ON AS BEING EXACT OR COMPLETE. THE CONTRACTOR MUST CALL THE APPROPRIATE UTILITY COMPANY AT LEAST 48 HOURS BEFORE ANY EXCAVATION TO REQUEST EXACT FIELD LOCATION OF ALL UTILITIES. IT SHALL BE THE RESPONSIBILITY OF THE CONTRACTOR TO LOCATE ALL EXISTING UTILITIES WHICH CONFLICT WITH PROPOSED IMPROVEMENTS SHOWN ON THE PLAN.
- F. CONTRACTOR IS TO REMOVE AND DISPOSE OF ALL DEBRIS, RUBBISH, AND OTHER MATERIALS RESULTING FROM PREVIOUS AND CURRENT DEMOLITION OPERATIONS. DISPOSAL WILL BE IN ACCORDANCE WITH ALL LOCAL, STATE AND/OR FEDERAL REGULATIONS GOVERNING SUCH OPERATIONS.
- G. PRIOR TO INSTALLATION OF ANY UTILITIES, THE CONTRACTOR IS TO EXCAVATE, VERIFY AND CALCULATE ALL CROSSINGS AND INFORM ANY AND ALL UTILITIES OF ANY CONFLICTS PRIOR TO CONSTRUCTION.
- H. CONSTRUCTION SHALL NOT START ON ANY WATER UTILITY TIE-INS UNTIL APPROVAL IS GIVEN BY BRYANT UTILITIES. SAID CONTRACTOR SHALL NOT OPERATE ANY VALVE, HYDRANT, OR WATER UTILITY APPURTENANCE NOR SHALL HE ATTACH TO OR TAP ANY WATER UTILITY MAIN WITHOUT APPROVAL. THE CONTRACTOR SHALL BEAR THE COST AND CONSEQUENCE OF ANY DISRUPTION OF UTILITY OPERATION CAUSED BY CONSTRUCTION.
- I. FIBER OPTIC CABLE ON AND/OR ADJACENT TO THIS SITE WERE NOT LOCATED BY THE SURVEY AND ARE NOT SHOWN. IT IS THE RESPONSIBILITY OF THE CONTRACTOR TO LOCATE ANY FIBER OPTIC CABLES ASSOCIATED WITH THIS SITE AND TAKE ALL NECESSARY AND REQUIRED PRECAUTIONS TO PROTECT ANY EXISTING FIBER OPTIC CABLES. CONTRACTORS SHALL COORDINATE ALL EFFORTS WITH OWNER OF FIBER OPTIC CABLES OR THEIR DESIGNATED REPRESENTATIVE.
- J. THE CONTRACTOR IS RESPONSIBLE FOR CONTACTING "ONECALL" SERVICE TO MARK ALL UTILITIES PRIOR TO ANY DEMOLITION, EARTHWORK, OR UTILITY WORK ON THIS SITE.

PHILLIP LEWIS ENGINEERING, INC.
 Structural + Civil Consultants
 23620 Interstate 30 | Bryant, Arkansas
 PH: 501-350-9840

REVISION:

SUMMERWOOD SPORTS GYMNASIUM #3
 7817 Hwy 5 N
 Bryant, Arkansas

JB-A4
 JUNCTION BOX
 STA: 3+46.29
 RIM: 409.52
 SUMP: 401.03
 INV IN: 401.13 18" EXISTING HDPE FROM JB-A3
 INV OUT: 401.10 18" EXISTING HDPE TO DETENTION POND

JB-A3
 NYLOPLAST INLINE DRAINS
 W/ 2x2" GRATE
 STA: 2+28.01
 RIM: 409.38
 SUMP: 404.56
 INV IN: 404.56 18" EXISTING HDPE FROM JB-A2
 INV OUT: 404.56 18" EXISTING HDPE TO JB-A4

JB-A2
 NYLOPLAST INLINE DRAIN
 W/ 2x2" GRATE
 STA: 0+51.09
 RIM: 412.25
 SUMP: 406.95
 INV IN: 406.95 18" EXISTING HDPE FROM
 INV OUT: 406.95 18" EXISTING HDPE TO JB-A3

AI-A1
 STA: 0+00.00
 SUMP: 411.18
 INV OUT: 411.18 18" HDPE PIPE

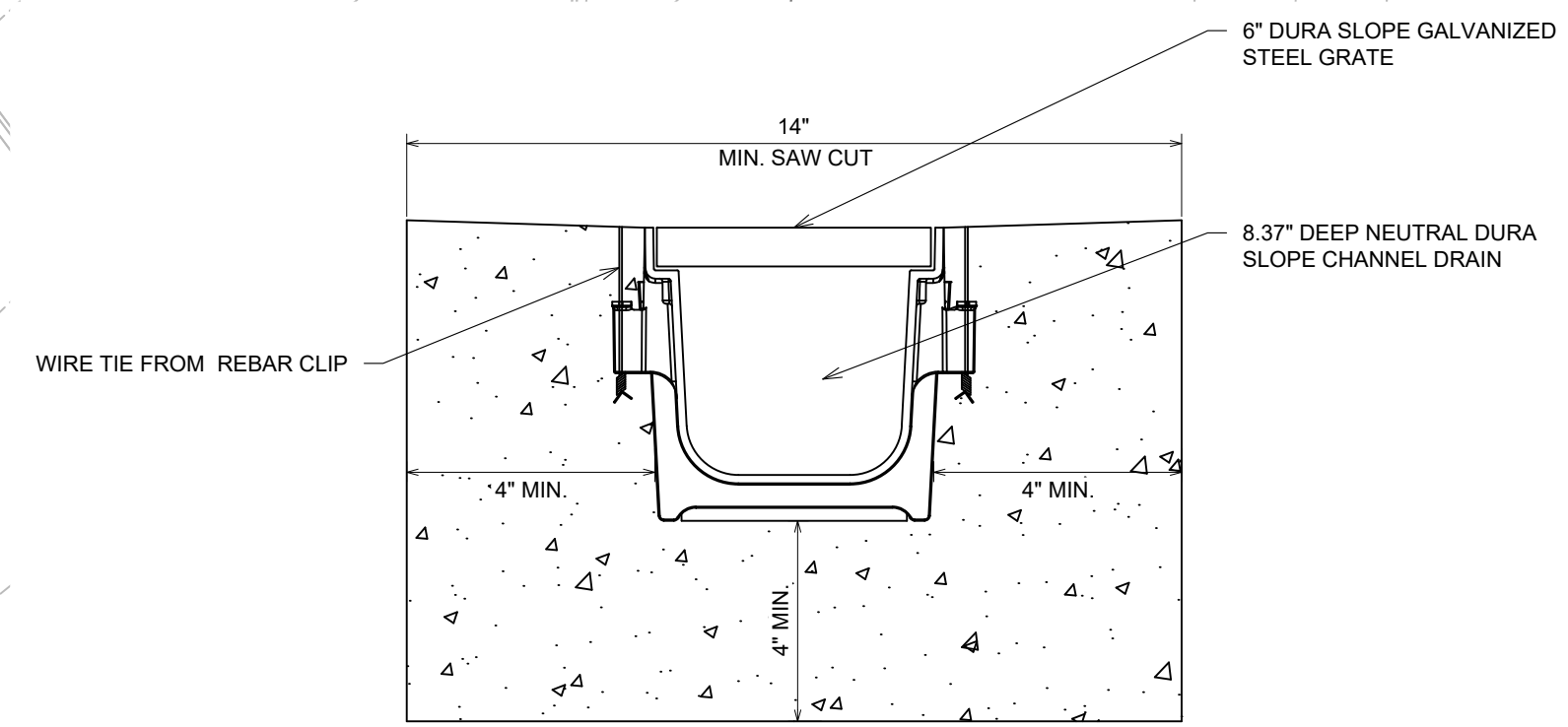

- NOTES:
 1. CHANNELS TO BE INSTALLED WITH GRATE. GRATE TO BE PROTECTED FROM CONCRETE POUR.
 2. INSTALLATION TO BE COMPLETED IN ACCORDANCE WITH MANUFACTURER'S SPECIFICATIONS.

NDS DURA SLOPE CHANNEL DRAIN SYSTEM
 TYPICAL CHANNEL DRAIN DETAIL. INSTALL SPECIFIED DRAIN SERIES OR SIMILAR LOAD RATING SERIES.

STORMWATER PLAN

SCALE 1" = 20'

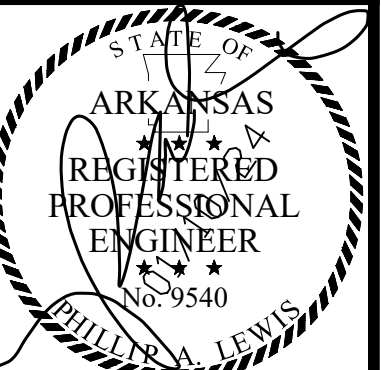
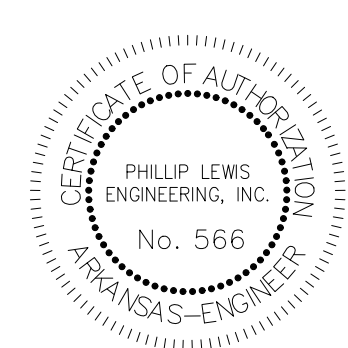
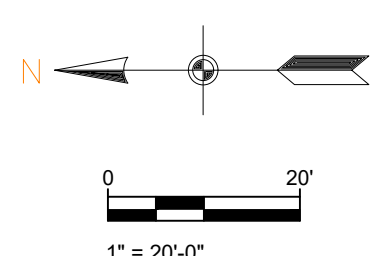

PROJECT NUMBER:

SHEET ISSUE DATE:
1/10/2024

PAGE TITLE:

STORMWATER PLAN

SHEET NUMBER:

C1.4

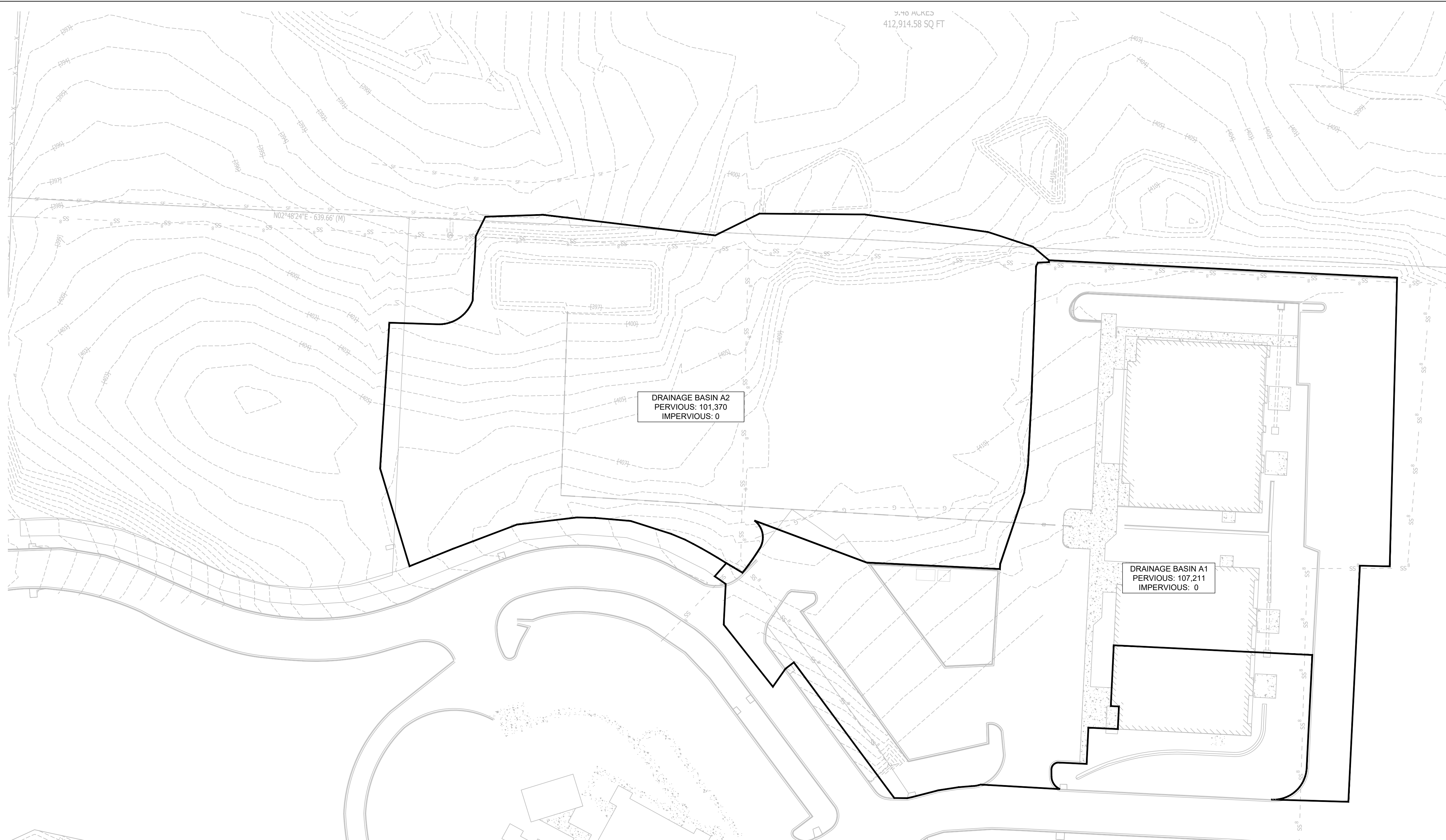

PRE-DEV DRAINAGE MAP

SCALE 1" = 40'

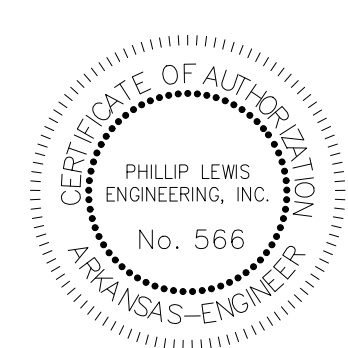
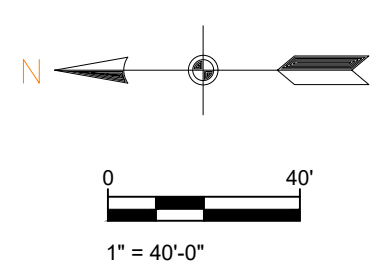

REVISION:

SUMMERWOOD SPORTS GYMNASIUM #3
 7817 Hwy 5 N
 Bryant, Arkansas

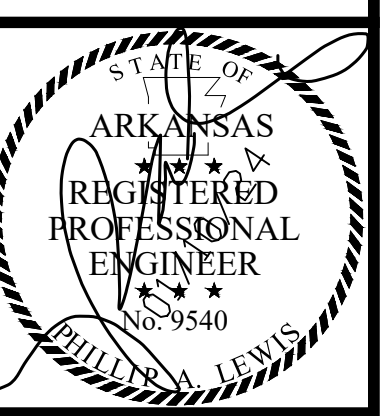

PROJECT NUMBER:

SHEET ISSUE DATE:
1/10/2024

PAGE TITLE:

PRE-DEV DRAINAGE MAP

SHEET NUMBER:

C1.5

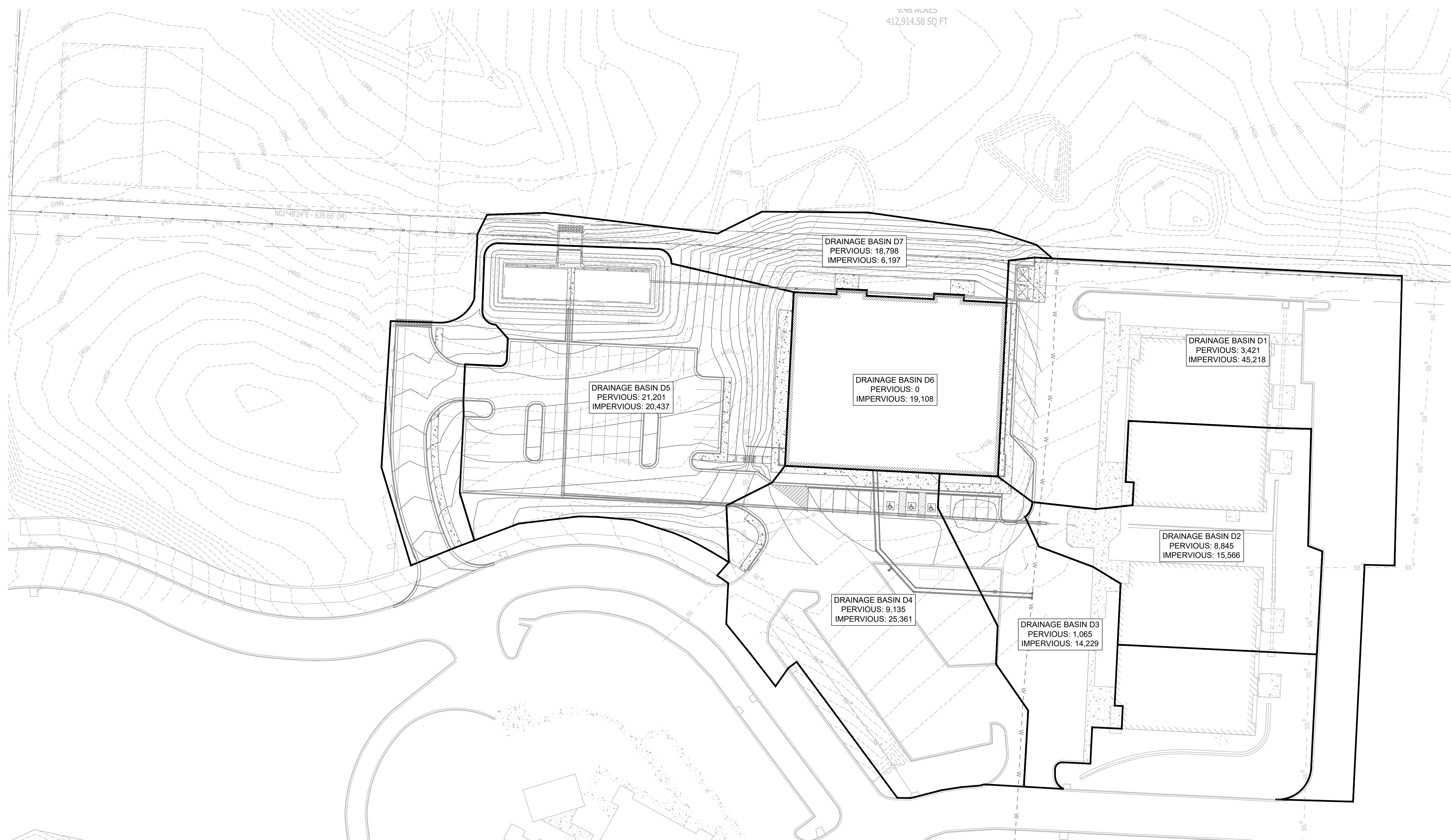

POST-DEV DRAINAGE MAP

SCALE 1" = 40'

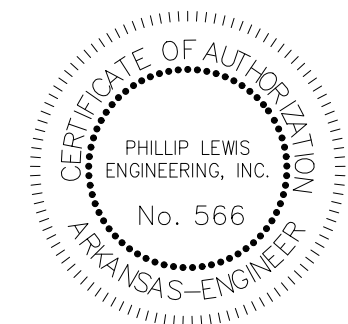
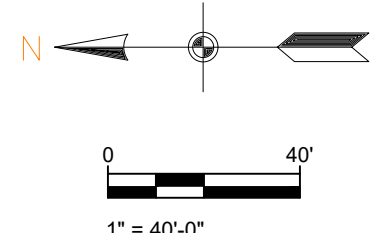

PHILLIP LEWIS ENGINEERING, INC.
Structural + Civil Consultants
23620 Interstate 30 | Bryant, Arkansas
PH: 501-350-9840

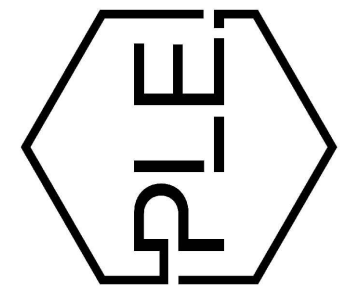

REVISION:

**SUMMERWOOD SPORTS
GYMNASIUM #3**
7817 Hwy 5 N
Bryant, Arkansas

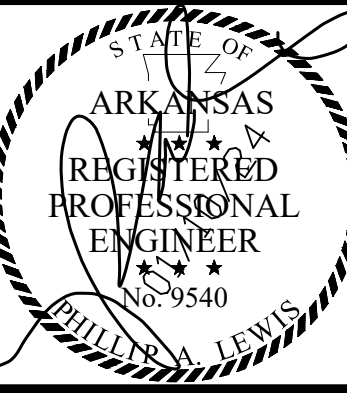

PROJECT NUMBER:

SHEET ISSUE DATE:
1/10/2024

PAGE TITLE:

POST-DEV
DRAINAGE MAP

SHEET NUMBER:

C1.6

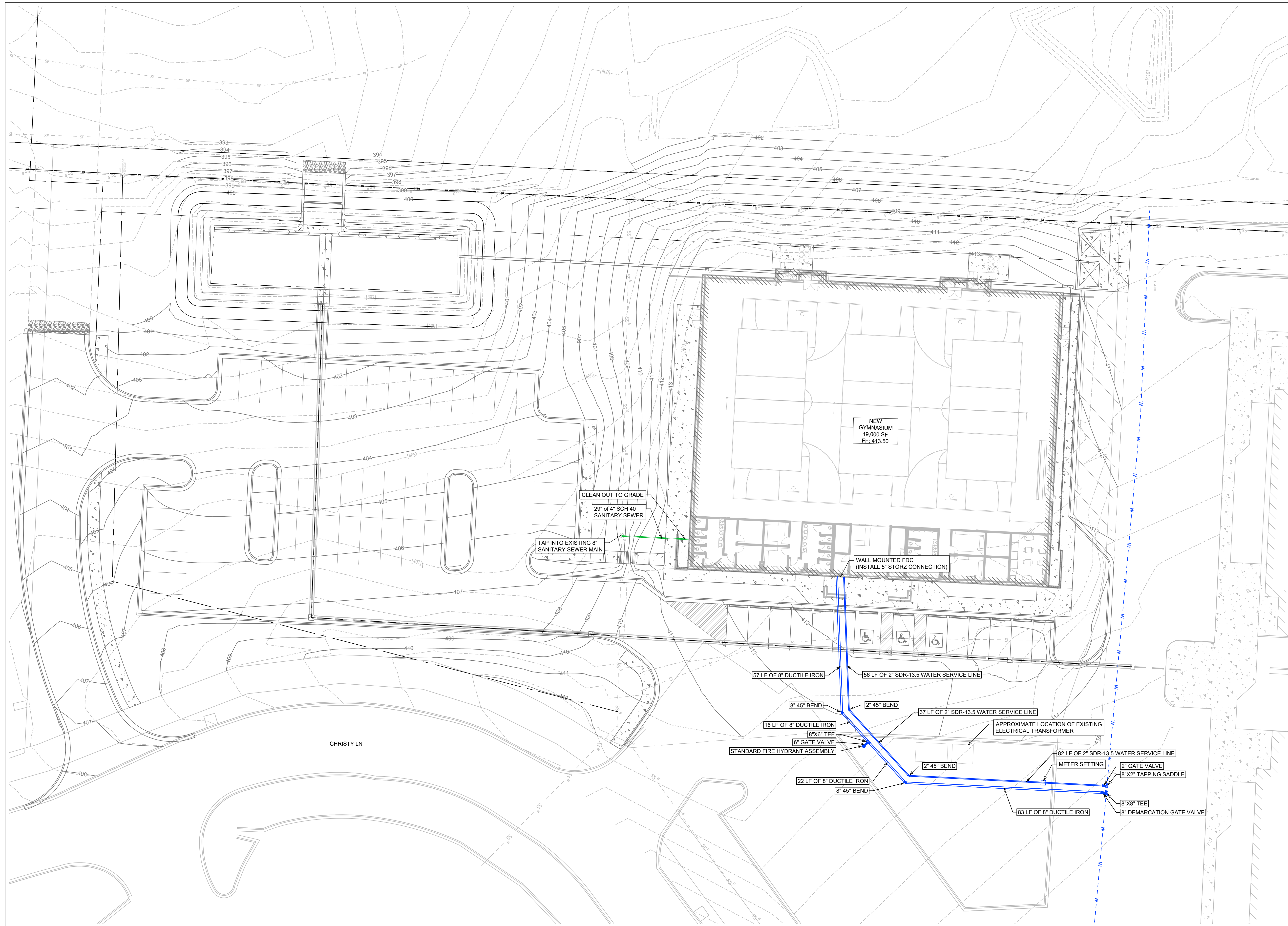

UTILITY PLAN

SCALE 1" = 20'

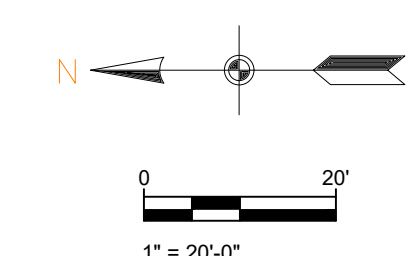

GENERAL CONSTRUCTION NOTES

- A. THE CONTRACTOR WILL BE HELD SOLELY RESPONSIBLE FOR DAMAGES OCCURRING TO ANY PROPERTY DURING THE CONSTRUCTION OF THIS PROJECT. SAID CONTRACTOR SHALL TAKE ALL NECESSARY PRECAUTIONS TO PREVENT PROPERTY DAMAGE.
- B. IN ACCORDANCE WITH GENERALLY ACCEPTED CONSTRUCTION PRACTICES, THE CONTRACTOR WILL SOLELY AND COMPLETELY BE RESPONSIBLE FOR CONDITIONS OF THE JOB SITE, INCLUDING SAFETY WORK. THIS REQUIREMENT WILL APPLY CONTINUOUSLY AND WILL NOT BE LIMITED TO NORMAL WORKING HOURS.
- C. THE DUTY OF BRYANT UTILITIES TO CONDUCT CONSTRUCTION INSPECTION REVIEWS OF THE CONTRACTOR'S PERFORMANCE IS NOT AN INSPECTION OR REVIEW OF THE ADEQUACY OF THE CONTRACTOR'S SAFETY MEASURES IN, ON, OR NEAR THE CONSTRUCTION SITE.
- D. ALL WATER AND SEWER IMPROVEMENTS SHALL BE CONSTRUCTED IN ACCORDANCE WITH THE LATEST REVISION TO THE CITY OF BRYANT'S WATER AND WASTEWATER (SANITARY SEWER) STANDARD SPECIFICATIONS.
- E. THE CONTRACTOR IS SPECIFICALLY CAUTIONED THAT THE LOCATION AND/OR ELEVATION OF EXISTING UTILITIES AS SHOWN ON THESE PLANS IS BASED ON RECORDS OF THE VARIOUS UTILITY COMPANIES AND, WHERE POSSIBLE, MEASUREMENTS TAKEN IN THE FIELD. THE INFORMATION IS NOT TO BE RELIED ON AS BEING EXACT OR COMPLETE. THE CONTRACTOR MUST CALL THE APPROPRIATE UTILITY COMPANY AT LEAST 48 HOURS BEFORE ANY EXCAVATION TO REQUEST EXACT FIELD LOCATION OF ALL UTILITIES. IT SHALL BE THE RESPONSIBILITY OF THE CONTRACTOR TO LOCATE ALL EXISTING UTILITIES WHICH CONFLICT WITH PROPOSED IMPROVEMENTS SHOWN ON THE PLAN.
- F. CONTRACTOR IS TO REMOVE AND DISPOSE OF ALL DEBRIS, RUBBISH, AND OTHER MATERIALS RESULTING FROM PREVIOUS AND CURRENT DEMOLITION OPERATIONS. DISPOSAL WILL BE IN ACCORDANCE WITH ALL LOCAL, STATE AND/OR FEDERAL REGULATIONS GOVERNING SUCH OPERATIONS.
- G. PRIOR TO INSTALLATION OF ANY UTILITIES, THE CONTRACTOR IS TO EXCAVATE, VERIFY AND CALCULATE ALL CROSSINGS AND INFORM ANY AND ALL UTILITIES OF ANY CONFLICTS PRIOR TO CONSTRUCTION.
- H. CONSTRUCTION SHALL NOT START ON ANY WATER UTILITY TIE-INS UNTIL APPROVAL IS GIVEN BY BRYANT UTILITIES. SAID CONTRACTOR SHALL NOT OPERATE ANY VALVE, HYDRANT, OR WATER UTILITY APPURTENANCE NOR SHALL HE ATTACH TO OR TAP ANY WATER UTILITY MAIN WITHOUT APPROVAL. THE CONTRACTOR SHALL BEAR THE COST AND CONSEQUENCE OF ANY DISRUPTION OF UTILITY OPERATION CAUSED BY CONSTRUCTION.
- I. FIBER OPTIC CABLE ON AND/OR ADJACENT TO THIS SITE WERE NOT LOCATED BY THE SURVEY AND ARE NOT SHOWN. IT IS THE RESPONSIBILITY OF THE CONTRACTOR TO LOCATE ANY FIBER OPTIC CABLES ASSOCIATED WITH THIS SITE AND TAKE ALL NECESSARY AND REQUIRED PRECAUTIONS TO PROTECT ANY EXISTING FIBER OPTIC CABLES. CONTRACTORS SHALL COORDINATE ALL EFFORTS WITH OWNER OF FIBER OPTIC CABLES OR THEIR DESIGNATED REPRESENTATIVE.
- J. THE CONTRACTOR IS RESPONSIBLE FOR CONTACTING "ONECALL" SERVICE TO MARK ALL UTILITIES PRIOR TO ANY DEMOLITION, EARTHWORK, OR UTILITY WORK ON THIS SITE.

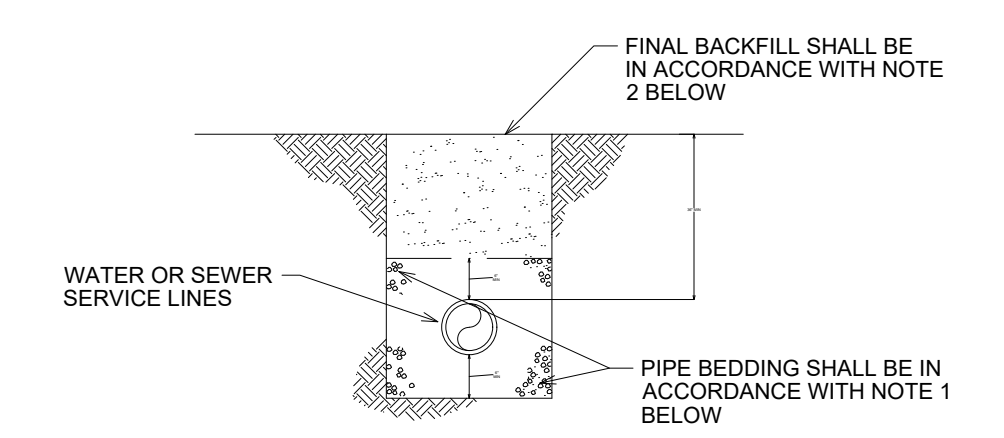

WATER AND SEWER LINES BEDDING DETAIL

- NOT TO SCALE
- NOTES:
 - 1. BEDDING SHALL BE "GRIT" PER ASTM 2774 OR ASTM D448 SIZE 67 A MINIMUM OF 6" ALL AROUND PIPE.
 - 2. INITIAL BACKFILL NOT UNDER PAVED AREAS CAN BE CLASS III COMPACTED TO 90% STANDARD PROCTOR. ALL BACKFILL UNDER PAVED AREAS SHALL BE CLASS 7 CRUSHED STONE (SB-2) COMPACTED TO 95% STANDARD PROCTOR DENSITY.
 - 3. ALL MATERIALS ARE CLASSIFIED IN ACCORDANCE WITH ASTM D2321-89.
 - 4. ALL MATERIALS SHALL BE INSTALLED IN MAXIMUM 8" LIFTS IN ACCORDANCE WITH ASTM D998. CLASS III AND IV-A MATERIALS SHALL BE COMPACTED TO NEAR OPTIMUM MOISTURE CONTENT.
 - 5. FILL SALVAGED FROM EXCAVATION SHALL BE FREE OF DEBRIS, ORGANICS, AND ROCKS LARGER THAN 3".
 - 6. ALL TRENCH EXCAVATIONS SHALL BE SLOPED, SHORED, SHEETED, BRACED, OR OTHERWISE SUPPORTED IN COMPLIANCE WITH OSHA REGULATIONS AND LOCAL ORDINANCES.

PHILLIP LEWIS ENGINEERING, INC.
Structural + Civil Consultants
23620 Interstate 30 | Bryant, Arkansas
PH: 501-350-9840

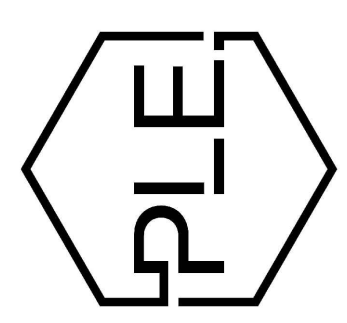

REVISION:

SUMMERWOOD SPORTS GYMNASIUM #3
7817 Hwy 5 N
Bryant, Arkansas

PRELIMINARY
NOT FOR CONSTRUCTION

PROJECT NUMBER:
SHEET ISSUE DATE:
1/10/2024
PAGE TITLE:
UTILITY PLAN
SHEET NUMBER:
C1.7

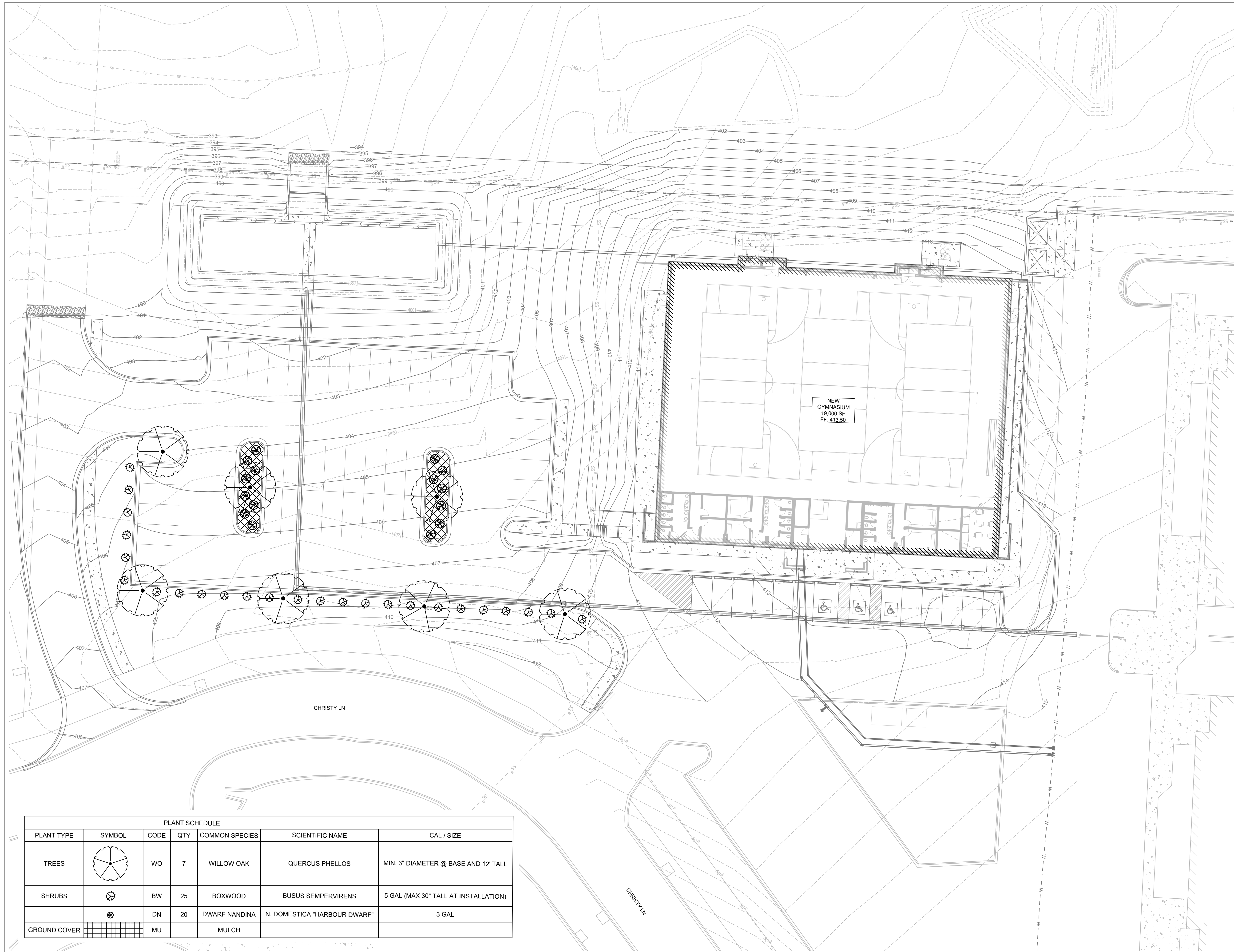

PLANT SCHEDULE						
PLANT TYPE	SYMBOL	CODE	QTY	COMMON SPECIES	SCIENTIFIC NAME	CAL / SIZE
TREES		WO	7	WILLOW OAK	QUERCUS PHELLOS	MIN. 3" DIAMETER @ BASE AND 12' TALL
SHRUBS		BW	25	BOXWOOD	BUSUS SEMPERVIRENS	5 GAL (MAX 30" TALL AT INSTALLATION)
		DN	20	DWARF NANDINA	N. DOMESTICA "HARBOUR DWARF"	3 GAL
GROUND COVER		MU		MULCH		

LANDSCAPING PLAN

THE ABOVE SPECIES IS OPTIONAL IF OWNER WANTS TO GO WITH THE SAME SPECIES AS ADJACENT PROPERTY

SCALE 1" = 20'

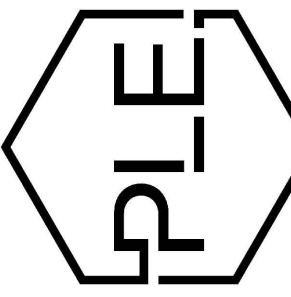
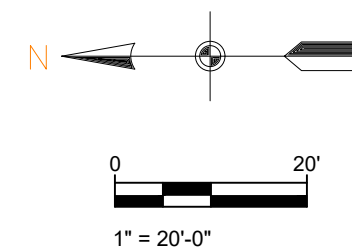

REVISION:

SUMMERWOOD SPORTS GYMNASIUM #3

7817 Hwy 5 N
Bryant, Arkansas

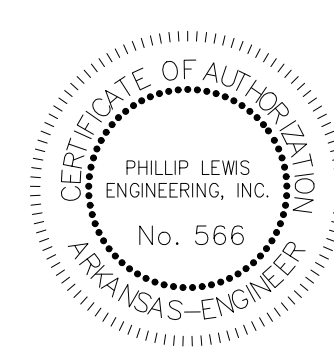

PROJECT NUMBER:

SHEET ISSUE DATE:
1/10/2024

PAGE TITLE:

LANDSCAPING PLAN

SHEET NUMBER:

C1.8



SWPPP PH. 1

SCALE 1" = 50'

LEGEND

- DISTURBED AREA
- UNDISTURBED AREA
- GRASS SEED
- SEDIMENT FENCE WITH WIRE BACKING
- DRAINAGE DIRECTION

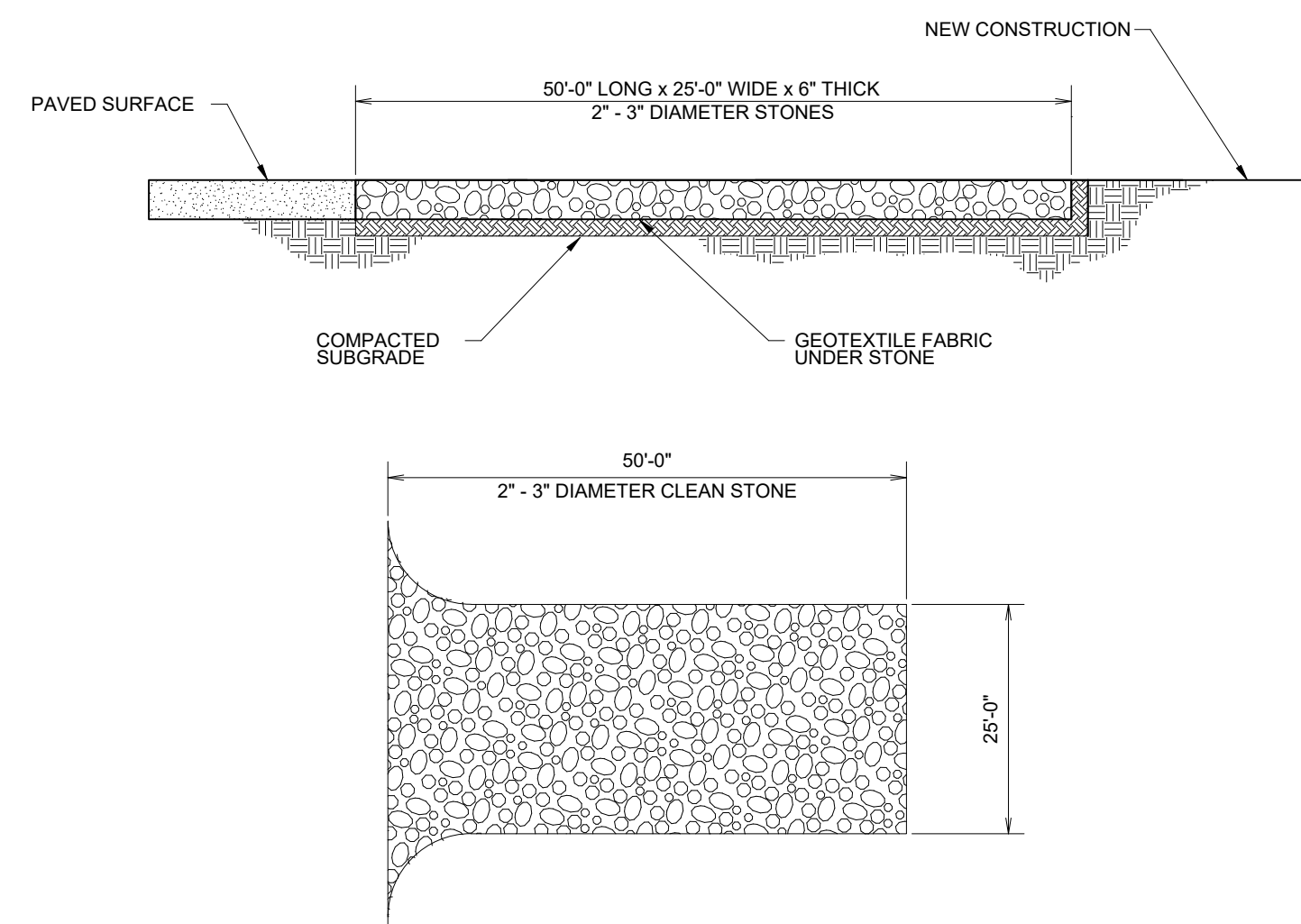

CONSTRUCTION ENTRANCE NOT TO SCALE

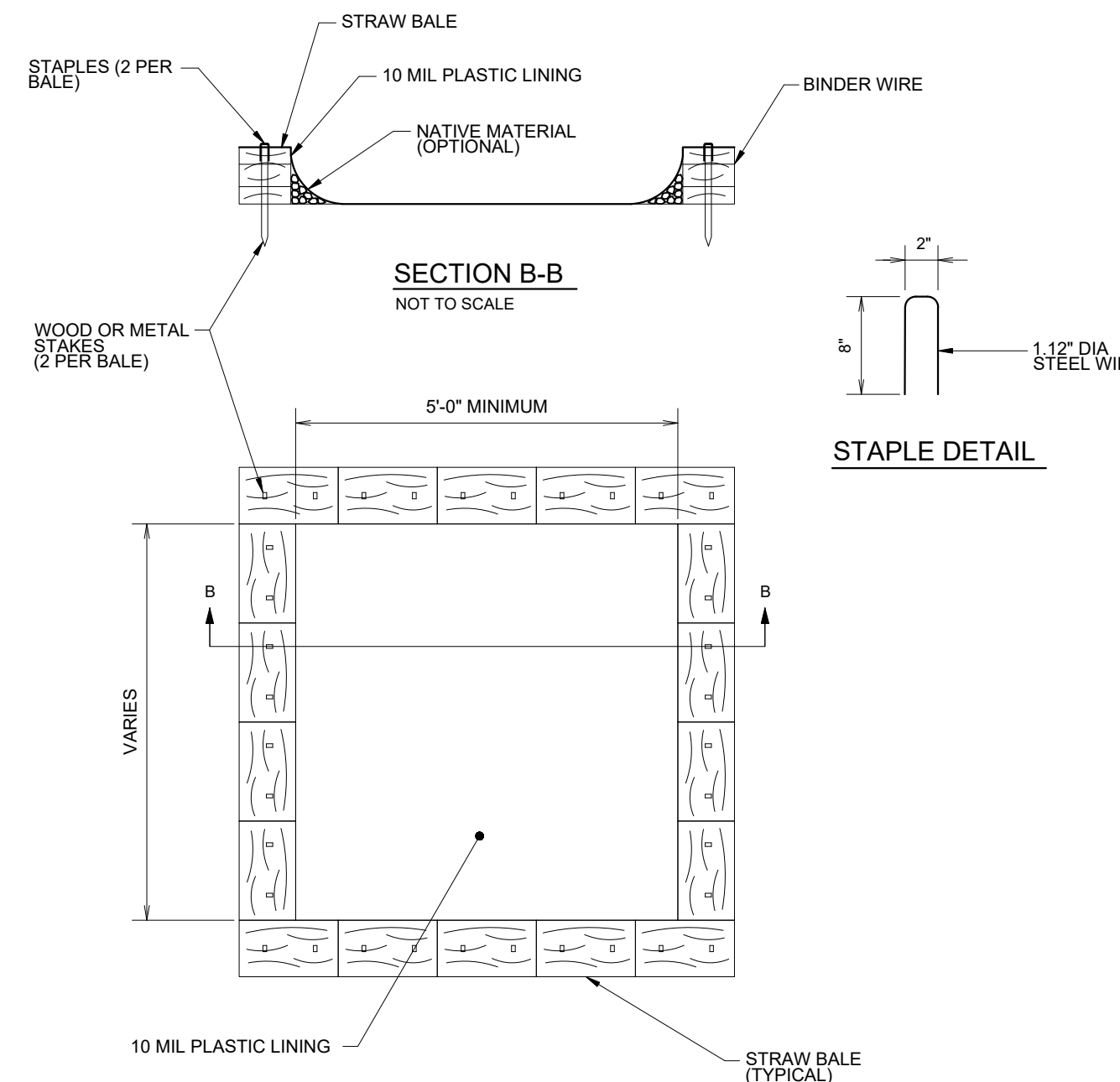

CONCRETE WASHOUT NOT TO SCALE

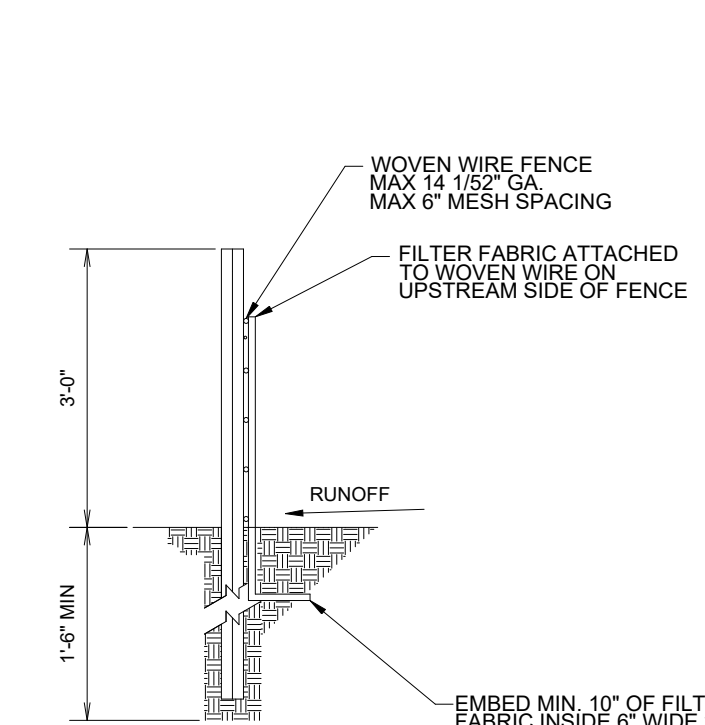

SILT FENCE NOT TO SCALE



STAPLE DETAIL

NOTES AND SPECIFICATIONS:

1. POSTS SHALL BE A MINIMUM OF 36 INCHES CONSTRUCTED OF EITHER OF THE FOLLOWING MATERIALS: STEEL 1" OR 1 1/2" TYPE, OR 2" x 2" HARDWOOD.
2. WOVEN WIRE USED AS ADDITIONAL FENCE SUPPORT SHALL BE MINIMUM 14.5 GA. WITH 6" MAXIMUM SPACING.
3. WOVEN WIRE SHALL BE PLACED ALONG THE UPHILL SIDE OF THE FENCE AND FASTENED WITH WIRE TIES OR 1" STAPLES ALONG THE UPHILL SIDE OF THE POSTS.
4. FILTER FABRIC SHALL BE FASTENED TO WOVEN WIRE ACCORDING TO MANUFACTURER'S RECOMMENDATION, OR WITH TIES EVERY 24" AT THE TOP AND MID-SECTIONS.
5. WHERE TWO PIECES OF FILTER FABRIC ADJOIN EACH OTHER THEY SHALL BE OVERLAPPED BY 6 INCHES AND FOLDED TOGETHER.
6. WHERE TWO POSTS MEET TO JOIN FENCE SECTIONS, THE TOPS OF THE POSTS SHALL BE SECURED TOGETHER WITH WIRE.
7. THE FENCE SHALL BE CONSTRUCTED ALONG THE CONTOUR AS MUCH AS POSSIBLE.
8. ENDS OF FENCES SHALL BE EXTENDED UP THE SLOPE TO PREVENT RUNOFF FROM MIGRATING AROUND THE END OF THE FENCE.
9. INSPECTION OF THE FENCE SHALL BE PERFORMED WEEKLY, OR IMMEDIATELY AFTER A RAIN EVENT, OR WHEN BULGES APPEAR IN THE FENCE. ACCUMULATED SILT SHALL NOT BE ALLOWED TO EXCEED HALF THE HEIGHT OF THE FABRIC. REPAIR AND OR REPLACEMENT OF DAMAGED FENCE SHALL BE COMPLETED PROMPTLY.
10. ACCUMULATED SILT SHALL BE REMOVED AND DISPOSED OF IN AN APPROVED SITE IN SUCH A MANNER THAT IT WILL NOT CONTRIBUTE TO OFF-SITE SILTATION.
11. ALL FENCING SHALL BE REMOVED WITH THE CONSTRUCTION SITE IS FULLY STABILIZED SO AS TO NOT IMPEDE STORM FLOW OR DRAINAGE.
12. PRE-FABRICATED UNITS DO NOT REQUIRE THE USE OF WOVEN WIRE FENCE.

NOTES (GENERAL):

1. SEE EROSION CONTROL DETAILS IN SWPPP FOR EROSION CONTROL FACILITIES.
2. SEE SWPPP FOR INSTALLATION, MAINTENANCE, INSPECTION, AND RECORD KEEPING REQUIREMENTS.
3. CONTRACTOR SHALL SHOW EROSION CONTROL MEASURE ON SITE MAP.
4. EROSION AND SEDIMENT CONTROL STRUCTURES TO MEET SWPPP DETAILS - APPENDIX D
5. INSTALL ROCK DITCH, CHECK, OR SAND BAG CHECKS AS NECESSARY TO PREVENT SCOUR UNTIL LANDSCAPING IS ESTABLISHED.
6. CONTRACTOR MUST PLACE SEDIMENT BASIN WITH SEDIMENT FENCE OUTLET FOR ANY SEDIMENT CONTAMINATED DEWATERING DISCHARGE.
7. FINAL SLOPE WILL BE SAME DIRECTION AS EXISTING SLOPE.

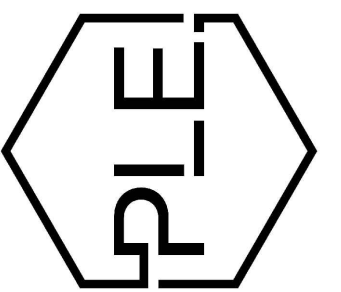
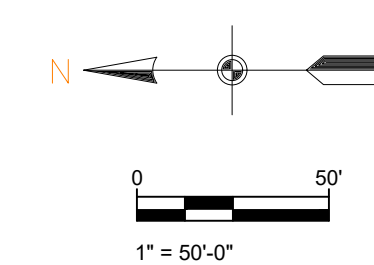

REVISION:

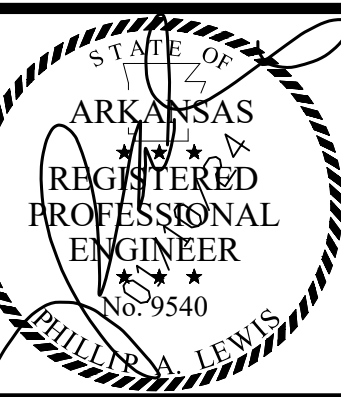
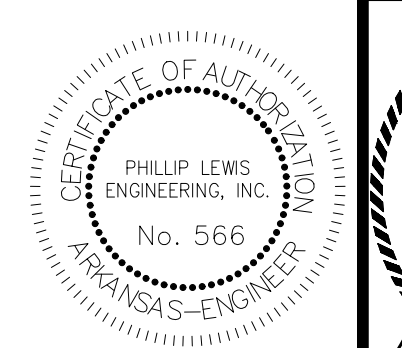

PROJECT NUMBER:

SHEET ISSUE DATE:
1/10/2024

PAGE TITLE:

SWPPP PH. 1

SHEET NUMBER:



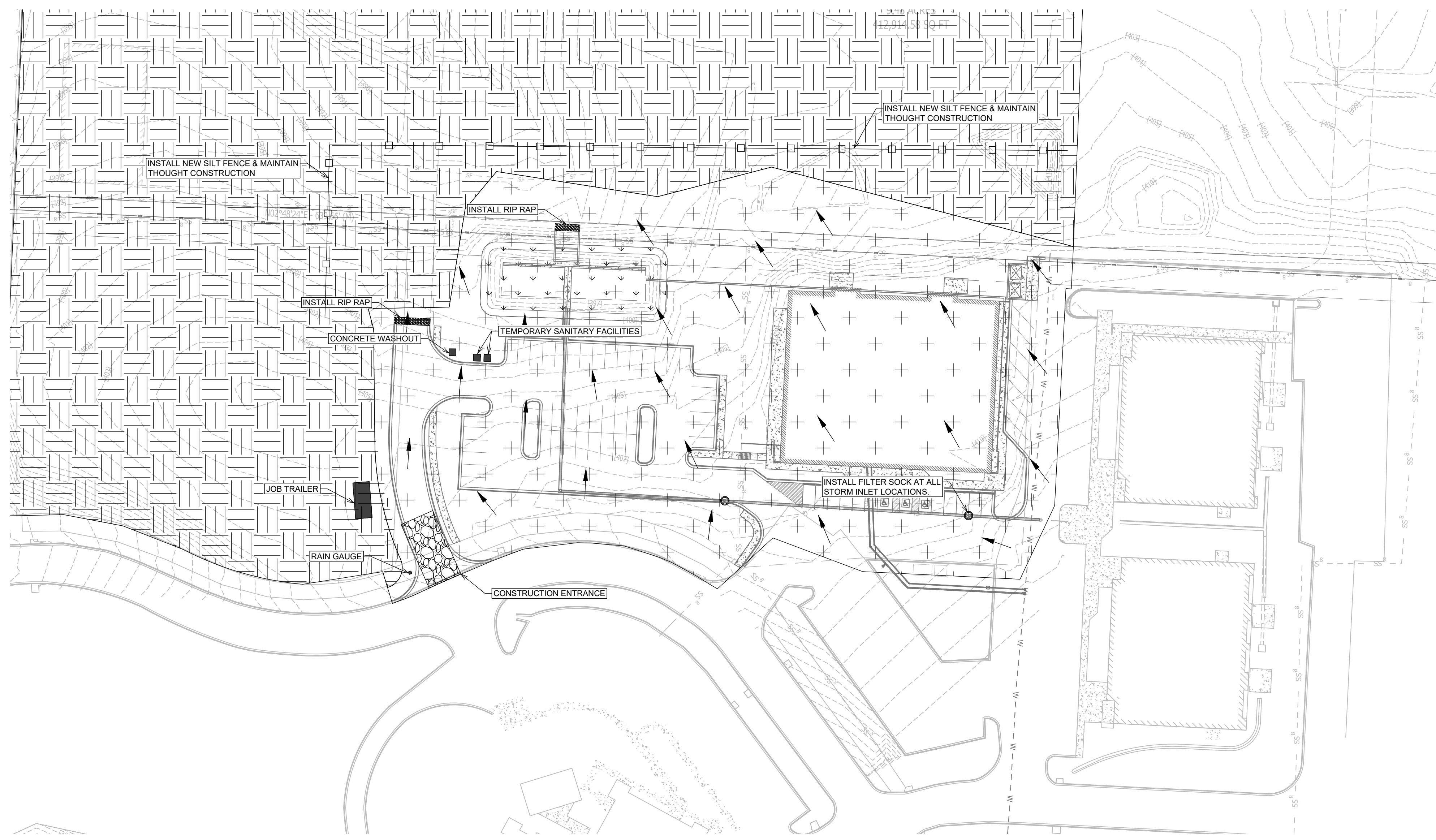

C1.9



SWPPP PH. 2

SCALE 1" = 50'

LEGEND

-  DISTURBED AREA
-  UNDISTURBED AREA
-  GRASS SEED
-  SEDIMENT FENCE WITH WIRE BACKING
-  DRAINAGE DIRECTION

NOTES (GENERAL):

1. SEE EROSION CONTROL DETAILS IN SWPPP FOR EROSION CONTROL FACILITIES.
2. SEE SWPPP FOR INSTALLATION, MAINTENANCE, INSPECTION, AND RECORD KEEPING REQUIREMENTS.
3. CONTRACTOR SHALL SHOW EROSION CONTROL MEASURE ON SITE MAP.
4. EROSION AND SEDIMENT CONTROL STRUCTURES TO MEET SWPPP DETAILS - APPENDIX D
5. INSTALL ROCK DITCH, CHECK, OR SAND BAG CHECKS AS NECESSARY TO PREVENT SCOUR UNTIL LANDSCAPING IS ESTABLISHED.
6. CONTRACTOR MUST PLACE SEDIMENT BASIN WITH SEDIMENT FENCE OUTLET FOR ANY SEDIMENT CONTAMINATED DEWATERING DISCHARGE
7. FINAL SLOPE WILL BE SAME DIRECTION AS EXISTING SLOPE.

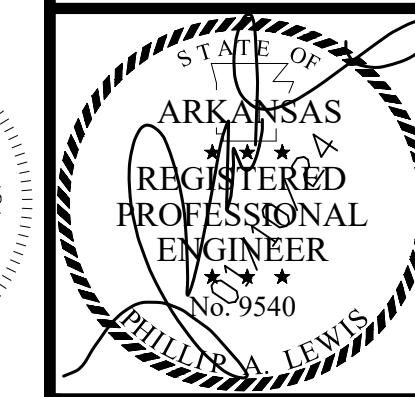
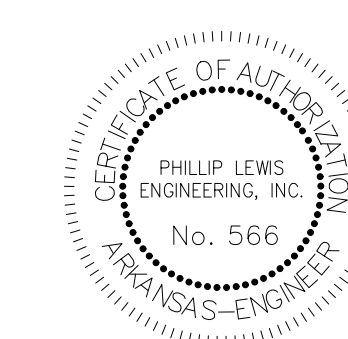
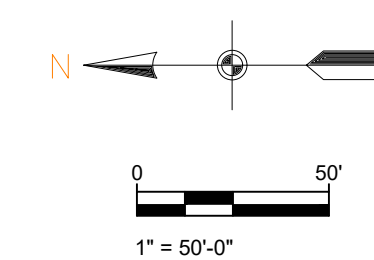

PROJECT NUMBER:

SHEET ISSUE DATE:
1/10/2024

PAGE TITLE:

SWPPP PH. 2

SHEET NUMBER:

C1.10

PHILLIP LEWIS ENGINEERING, INC.
Structural + Civil Consultants
23620 Interstate 30 | Bryant, Arkansas
PH: 501-350-9840

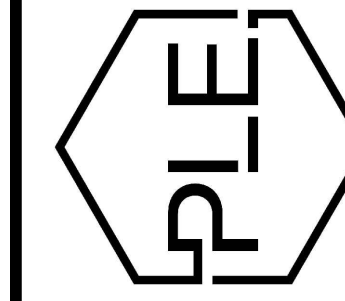

REVISION:

**SUMMERWOOD SPORTS
GYMNASIUM #3**
7817 Hwy 5 N
Bryant, Arkansas



PHILLIP LEWIS ENGINEERING

Structural + Civil Consultants

23620 Interstate 30 | Bryant, AR
PH: 501-350-9840

January 10, 2023

Colton Leonard
City Planner
City of Bryant
210 SW 3rd St.
Bryant, AR 72022

To whom it may concern,

This is a formal request to be placed on the upcoming Design Review Committee agenda for a Small Scale Development application pertaining to the Summerwood Sports Gymnasium #3 project. This is the third gym installment of the Summerwood Sports complex located along Hwy 5 and Bryant Parkway. The civil and architectural plans accompany this letter.

If you have any questions, please give me a call.

Sincerely,
Phillip Lewis, P.E.
501-350-9840

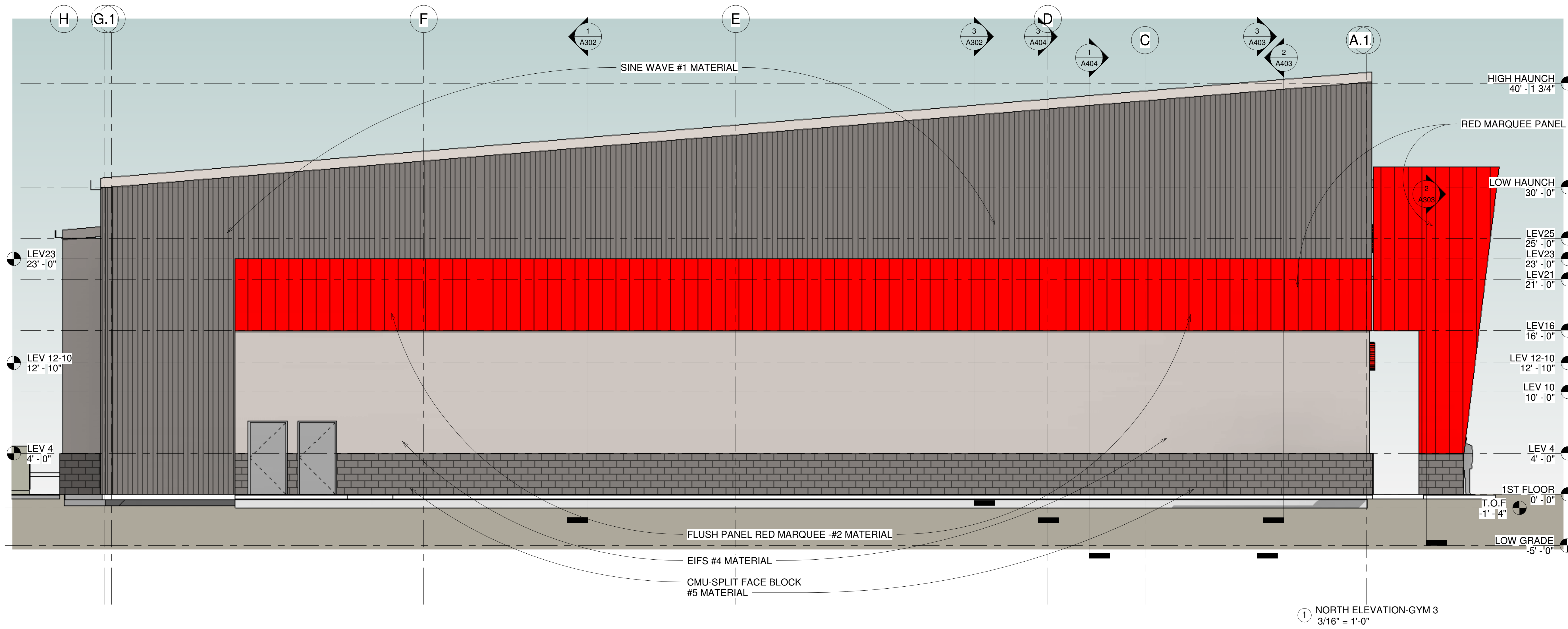

FRONT ELEVATION-% OF AREA MATERIALS LISTED

1. TOP-CHARCOAL COLOR -METAL PANELS WITH SINE WAVE=2,336 SF
2. RED COLOR -FLUSH METAL PANELS =1,394 SF
3. BLUE COLOR- GLASS AND DOORS=308 SF
4. DARK GRAY COLOR - EIFS TYPE STUCCO=1,472 SF
5. BASE-CHARCOAL COLOR -SPLIT FACE BLOCK=544 SF

TOTAL SF FRONT ELEVATION=6,054 SF
 CHARCOAL COLOR SINE WAVE METAL =38.5% OF AREA
 RED COLOR FLUSH METAL PANEL= 23% OF AREA
 GLASS= 5.0% OF AREA

SIDE ELEVATIONS -% OF AREA MATERIALS LISTED
 EAST AND WEST ELEVATIONS ARE IDENTICAL BUT MIRRORED

1. TOP-CHARCOAL COLOR -METAL PANELS WITH SINE WAVE=1,771 SF
2. RED COLOR -FLUSH METAL PANELS = 1,020 SF
3. LIGHT GRAY COLOR - EIFS TYPE STUCCO= 1,326 SF
4. BASE-CHARCOAL COLOR -SPLIT FACE BLOCK= 452 SF

TOTAL SF SIDE ELEVATION=4,569 SF
 TOP-CHARCOAL SINE WAVE METAL =38% OF AREA
 RED COLOR FLUSH METAL PANEL = 22.3% OF AREA

EXTERIOR MATERIALS LISTED FROM TOP OF BUILDING TO FLOOR-ALL METAL SIDING HAS CONCEALED FASTENERS

1. TOP-CHARCOAL COLOR -METAL PANELS WITH SINE WAVE AND W/CONCEALED FASTENERS AT TOP OF WALL
2. RED COLOR WALL STRIPE -FLUSH METAL PANELS W/CONCEALED FASTENERS AT 16' TO 23' ABOVE FLR.
3. RED COLOR AT COVERED ENTRY FEATURES-FLUSH METAL PANELS W/CONCEALED FASTENERS
4. BLUE COLOR=INSULATED GLASS AND STOREFRONT TYPE DOORS
5. LIGHT GRAY COLOR - EIFS TYPE STUCCO-FROM 4'-0" TO 16' ABOVE FLR.
6. BASE-CHARCOAL COLOR -SPLIT FACE BLOCK AT BASE OF WALL TO 4'-0" ABOVE FLR.
7. LIGHT GRAY COLOR-PAINTED METAL EXIT DOORS

REAR ELEVATION -% OF AREA MATERIALS LISTED

RECESSED MATERIALS ARE COUNTED AS SF- SEE OTHER SHEET FOR REAR ELEVATION

1. TOP-CHARCOAL COLOR -METAL PANELS WITH SINE WAVE= 2,013 SF
2. DARK GRAY COLOR - EIFS TYPE STUCCO= 2,098 SF
3. BASE-CHARCOAL COLOR -SPLIT FACE BLOCK= 456 SF

TOTAL SF REAR ELEVATION=4,567 SF
 TOP-CHARCOAL SINE WAVE METAL =44 % OF WALL AREA

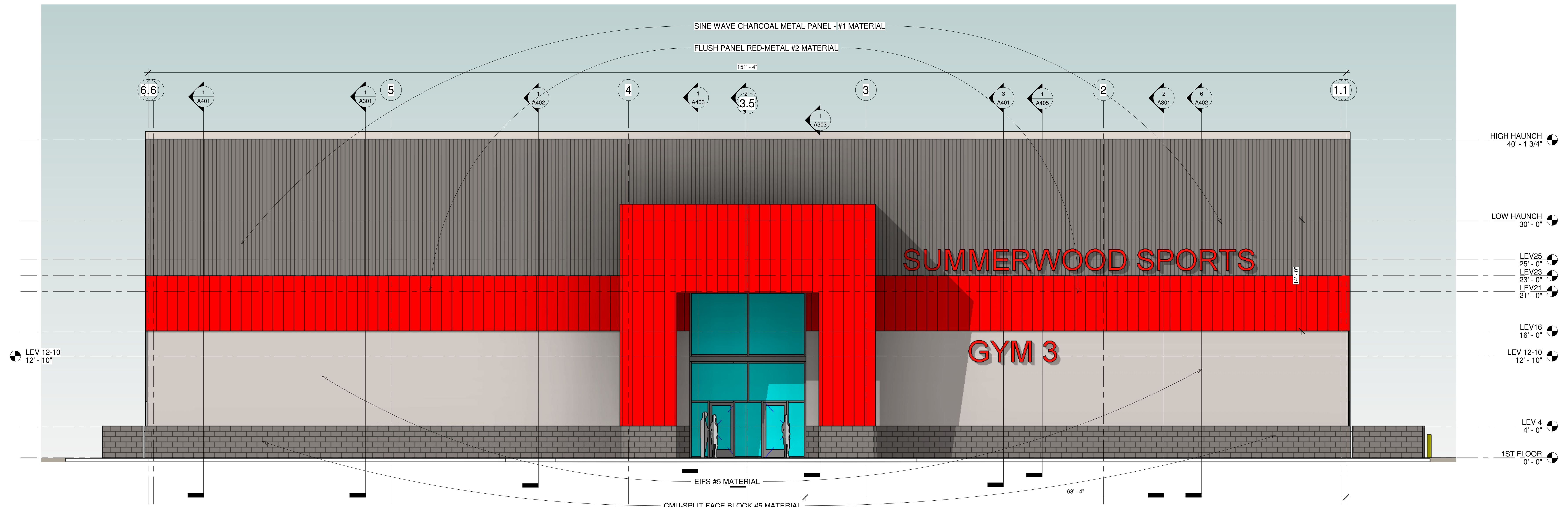

② FRONT WEST ELEVATION-GYM 3
 3/16" = 1'-0"

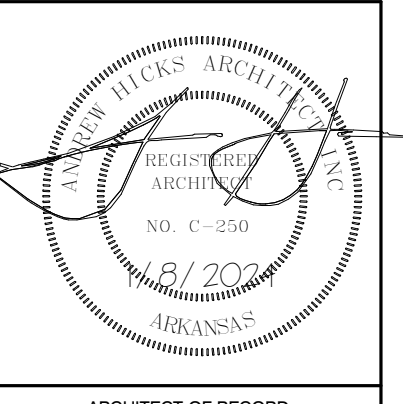

ARCHITECT OF RECORD
 ANDREW F. HICKS
 FOR SUMMERWOOD PARTNERS
 VERNIA OFFICE PARK, BRYANT PARKWAY
 BRYANT, ARKANSAS

andrew hicks | architect
AHIA
 P.O. BOX 1000
 BRYANT, AR 72015
 P: 501-660-0789
 F: 501-660-0789
 WWW.ANDREWHICKSARCHITECT.COM

REVISIONS	
NO.	DATE

ELEVATIONS-GYM 3
A200

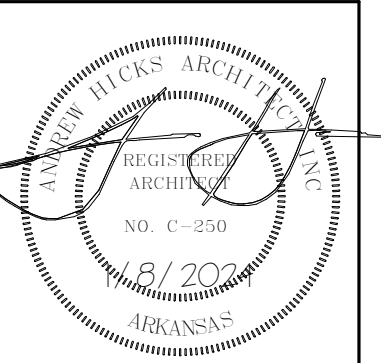

ARCHITECT OF RECORD
ANDREW F. HICKS

FOR SUMMERWOOD PARTNERS
VERNIA OFFICE PARK, BRYANT PARKWAY
BRYANT, ARKANSAS

andrew hicks | architect
AHIA
P.O. BOX 1000
600 N. Mission Blvd.
Fayetteville, AR 72701
PH: 479-332-5050
WWW.ANDREWHICKSARCHITECT.COM

ISSUE DATE: 1/8/2024

REVISIONS	
NO.	DATE

ELEVATIONS-GYM 3

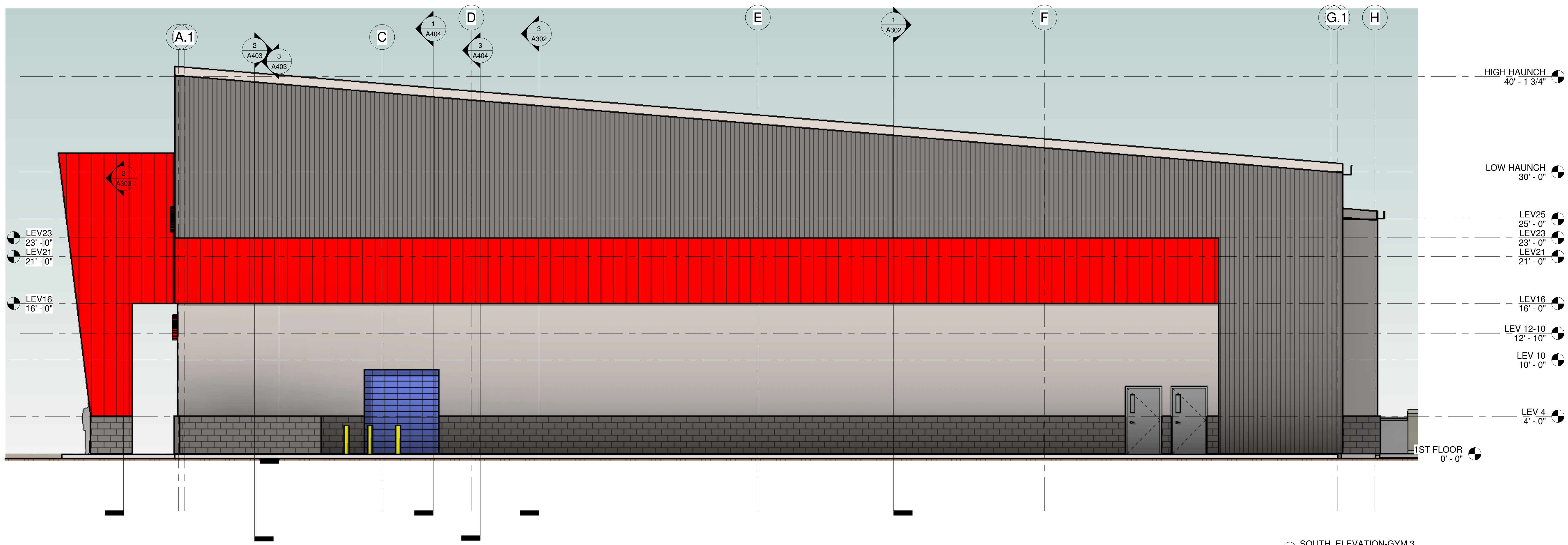

HIGH HAUNCH
40' - 1 3/4"

LOW HAUNCH
30' - 0"

LEV25
25' - 0"

LEV23
23' - 0"

LEV21
21' - 0"

LEV16
16' - 0"

LEV 12-10
12' - 10"

LEV 10
10' - 0"

LEV 4
4' - 0"

1ST FLOOR
0' - 0"

1 SOUTH ELEVATION-GYM 3
3/16" = 1'-0"

EXTERIOR MATERIALS LISTED FROM TOP OF BUILDING TO FLOOR-ALL METAL SIDING HAS CONCEALED FASTENERS

1. TOP-CHARCOAL COLOR -METAL PANELS WITH SINE WAVE AND W/CONCEALED FASTENERS AT TOP OF WALL
2. RED COLOR WALL STRIPE -FLUSH METAL PANELS W/CONCEALED FASTENERS AT 16' TO 23' ABOVE FLR.
3. RED COLOR AT COVERED ENTRY FEATURES-FLUSH METAL PANELS W/CONCEALED FASTENERS
4. BLUE COLOR=INSULATED GLASS AND STOREFRONT TYPE DOORS
5. LIGHT GRAY COLOR - EIFS TYPE STUCCO-FROM 4'-0" TO 16' ABOVE FLR.
6. BASE-CHARCOAL COLOR -SPLIT FACE BLOCK AT BASE OF WALL TO 4'-0" ABOVE FLR.
7. LIGHT GRAY COLOR-PAINTED METAL EXIT DOORS

**REAR ELEVATION -% OF AREA MATERIALS LISTED
RECESSED MATERIALS ARE COUNTED AS SF**

1. TOP-CHARCOAL COLOR -METAL PANELS WITH SINE WAVE= 2,013 SF
 2. DARK GRAY COLOR - EIFS TYPE STUCCO= 2,098 SF
 3. BASE-CHARCOAL COLOR -SPLIT FACE BLOCK= 456 SF
- TOTAL SF REAR ELEVATION=4,567 SF
TOP-CHARCOAL SINE WAVE METAL =44 % OF WALL AREA

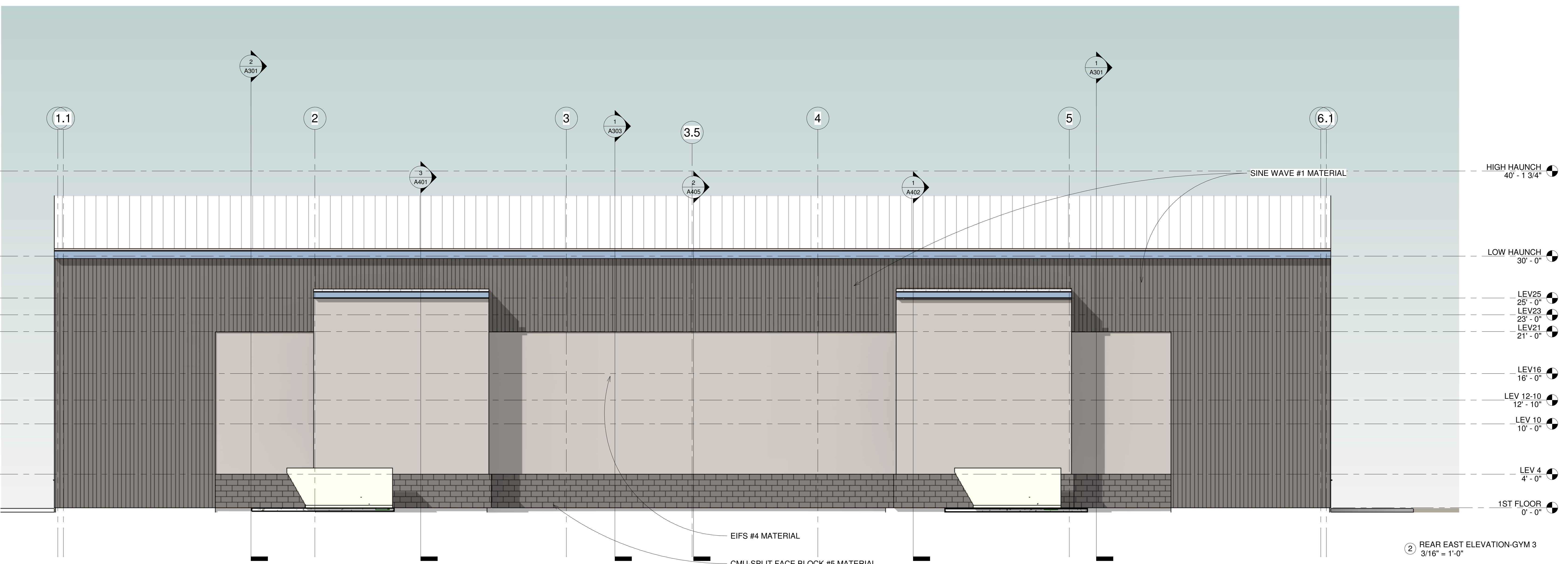

HIGH HAUNCH
40' - 1 3/4"

LOW HAUNCH
30' - 0"

LEV25
25' - 0"

LEV23
23' - 0"

LEV21
21' - 0"

LEV16
16' - 0"

LEV 12-10
12' - 10"

LEV 10
10' - 0"

LEV 4
4' - 0"

1ST FLOOR
0' - 0"

2 REAR EAST ELEVATION-GYM 3
3/16" = 1'-0"

SUMMERWOOD SPORTS GYM #3

DRAINAGE REPORT

Date: 01-10-2024

Located in: Bryant, Arkansas

Prepared for:
City of Bryant, Arkansas

Prepared by:

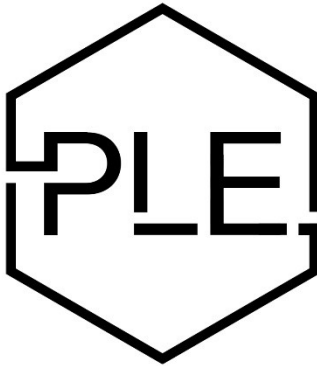

PHILLIP LEWIS ENGINEERING

Structural + Civil Consultants

23620 Interstate 30 | Bryant, AR
PH: 501-350-9840

CERTIFICATION

I hereby state that this Final Drainage has been prepared by me or under my supervision and meets the standard of care and expertise which is usual and customary in this community of professional engineers. The analysis has been prepared utilizing procedures and practices by the City of Bryant and within the standard accepted practices.



Phillip A. Lewis, PE.

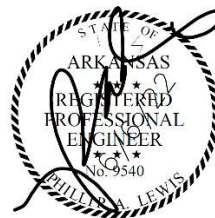
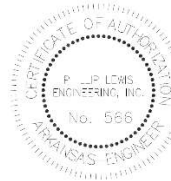

DATE: 01-10-2024

PROJECT LOCATION MAP



DESCRIPTION OF PROPERTY

The proposed project is for the construction of the third gymnasium of the Summerwood Sports Complex located along Bryant Parkway and Hwy 5. The proposed development is a 19,000 sq. ft. building and parking lot.

The intent of this drainage analysis is to reevaluate the previous drainage design and ensure that the completion of this development still meets the design intent and capacity of the previous constructed onsite detention facilities.

The existing ground coverage for the entire development drainage basin consisted of and partially still consists of natural vegetation (3%-8% slope), hydrologic soil group C/D (C = 0.50).

According to FEMA Flood Insurance Rate Map, Panel 05125C0240E, this property lies within Zone X, areas determined to be outside the 0.2% annual chance floodplain. A copy of the map can be found in the appendix.

DRAINAGE CRITERIA

In accordance with the requirements of the City of Bryant, the proposed developments drainage plan and this drainage report were developed with the criteria established in the Bryant Stormwater Management & Drainage Manual provided on cityofbryant.com.

All drainage calculations were performed using HydroCAD software to determine and analyze the changes in storm runoff volume, flow rates, and design the outlet release structure. Hydraflow Express software was used to appropriately design and size all storm sewer inlets, pipes and channels.

Calculations were performed using the Rational Method, using NOAA rainfall data, and the pond volume and outlet structure was determined by the 100-year storm event while

the outlet structure is designed to match or reduce pre-development flow rates for all storm events: 2-yr, 10-yr, 25-yr, and 100-yr storms.

Detention Basin Design Specifications:

- *3:1 maximum side slopes*
- *Outlet structures designed to reduce flow rate to match or reduce the pre-development runoff rates for the 2-yr, 5-yr, 10-yr, 25-yr and 100-yr storms.*
- *The pond bottom and side is to be solid sod to prevent erosion*
- *The basins are located and designed to allow access for continued maintenance after construction is completed*

DESCRIPTION OF PREVIOUS DETENTION FACILITIES

Phillip Lewis Engineering has evaluated the previously supplied drainage analysis and made site investigations to fully understand the current drainage situation.

The previous drainage analysis studied the pre vs. post scenarios as a single 6 acre node. Post development was studied as one node routing through the detention pond that is now constructed on the site. Due to the nature of how phase one construction evolved, some areas were not routed to this detention pond. Some of these areas ultimately discharge to other detention facilities located elsewhere on the site, and some are freely discharged to the adjacent eastern parcel.

This drainage study is intended to account for these discrepancies and ensure that the detention basin is throttling appropriately to offset the free discharges from the previous phase and this new proposed phase.

PROPOSED DRAINAGE SYSTEM

This development is designed to capture the majority of runoff within the parking lot curb and gutter, collecting stormwater with “Nyloplast” area inlets, and downspout collector pipes. The existing storm sewer network will remain, with the addition of two area grates along the frontage of gym #3. The existing detention basin that was constructed for the first two gymnasiums will remain as planned previously with the development of gym 1 and 2. This drainage analysis will provide supporting evidence to validate the previously constructed detention basin’s functionality.

While the pond footprint will remain as constructed, current design plans detail for this pond rim to be reestablished at the intended 400.00’ elevation, and for adequate trickle channels to be constructed within the pond bottom (per city of Bryant Requirements).

The detention pond was designed to detain stormwater volumes based off the 100-yr storm events with a concrete overflow spillway to release water if a rainfall event were to exceed the 100-yr storm event. The outlet control structures are detailed within this report.

Overall Pre-development and Post-development runoff/discharge rates are compared below:

Storm Event	Pre-development Discharge (cfs)	Post-development Discharge (cfs)
2-yr	10.33	10.14
5-yr	12.27	12.27
10-yr	13.82	13.74
25-yr	15.94	15.69
100-yr	18.93	18.25

Overall pre development and post development discharge rates are displayed in the following hydrographs. A final discharge link has been added to each to show one comparable discharge number. This final discharge will verify that the design detention basin should offset any bypassing watershed within the development.

PRE DEVELOPMENT HYDROGRAPHS

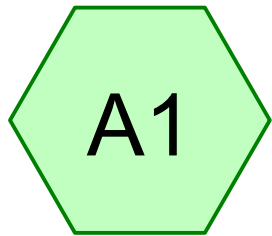

Drainage Basin A1

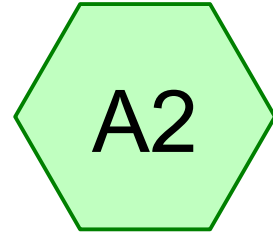

Drainage Basin A2

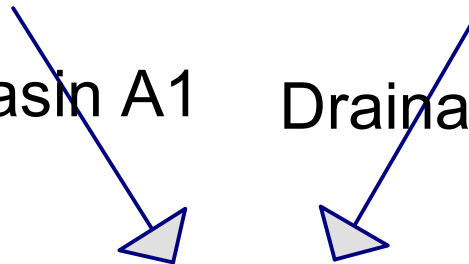

Pre Dev Runoff

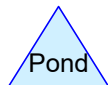
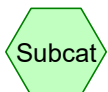

Summerwood Gym 3

Prepared by Phillip Lewis Engineering

HydroCAD® 10.20-2f s/n 12520 © 2022 HydroCAD Software Solutions LLC

AR - Little Rock 2-yr Duration=10 min, Inten=4.36 in/hr

Printed 1/11/2024

Summary for Subcatchment A1: Drainage Basin A1

Runoff = 5.31 cfs @ 0.17 hrs, Volume= 3,242 cf, Depth= 0.36"
Routed to Link Pre-Dev : Pre Dev Runoff

Runoff by Rational method, Rise/Fall=1.0/1.0 xTc, Time Span= 0.00-3.00 hrs, dt= 0.01 hrs
AR - Little Rock 2-yr Duration=10 min, Inten=4.36 in/hr

Area (sf)	C	Description
107,211	0.50	Existing Natural Vegetation
107,211		100.00% Pervious Area

Tc (min)	Length (feet)	Slope (ft/ft)	Velocity (ft/sec)	Capacity (cfs)	Description
10.0	415		0.69		Direct Entry, Overland Concentrated Flow (Min)

Subcatchment A1: Drainage Basin A1

Hydrograph

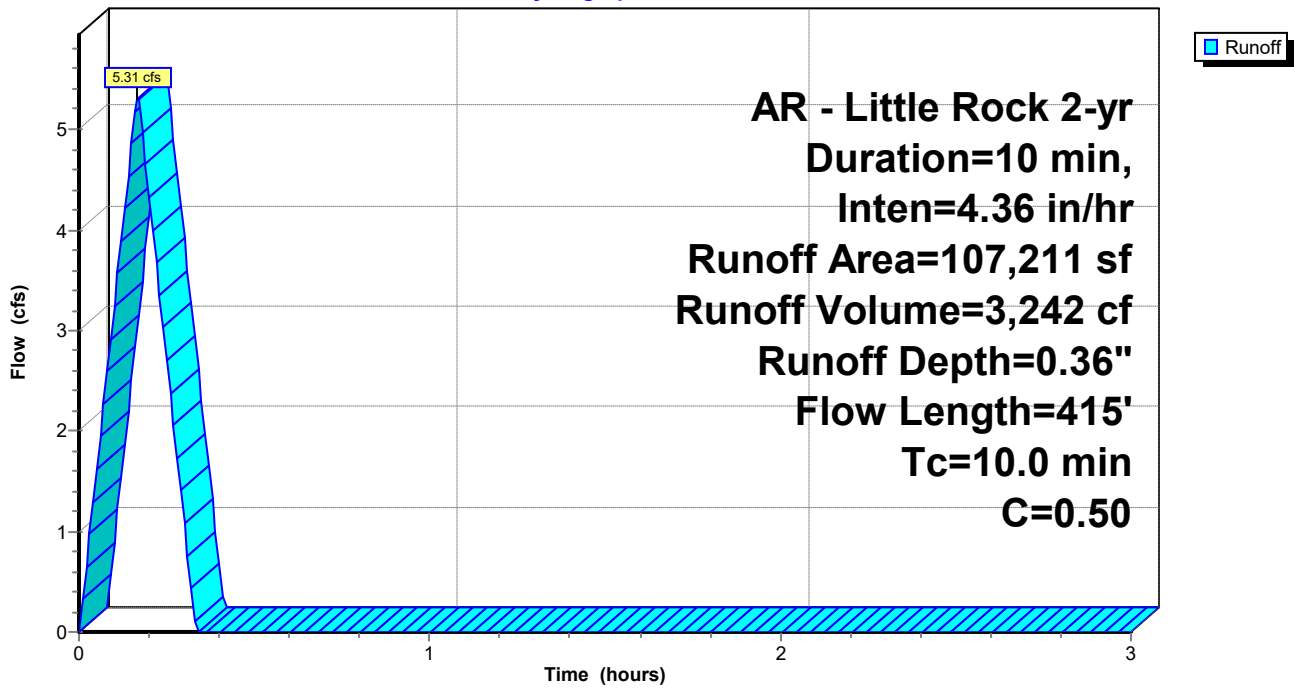

Summerwood Gym 3

Prepared by Phillip Lewis Engineering

HydroCAD® 10.20-2f s/n 12520 © 2022 HydroCAD Software Solutions LLC

AR - Little Rock 2-yr Duration=10 min, Inten=4.36 in/hr

Printed 1/11/2024

Summary for Subcatchment A2: Drainage Basin A2

Runoff = 5.02 cfs @ 0.17 hrs, Volume= 3,065 cf, Depth= 0.36"
Routed to Link Pre-Dev : Pre Dev Runoff

Runoff by Rational method, Rise/Fall=1.0/1.0 xTc, Time Span= 0.00-3.00 hrs, dt= 0.01 hrs
AR - Little Rock 2-yr Duration=10 min, Inten=4.36 in/hr

Area (sf)	C	Description
101,370	0.50	Existing Natural Vegetation
101,370		100.00% Pervious Area

Tc (min)	Length (feet)	Slope (ft/ft)	Velocity (ft/sec)	Capacity (cfs)	Description
10.0	415		0.69		Direct Entry, Overland Concentrated Flow (Min)

Subcatchment A2: Drainage Basin A2

Hydrograph

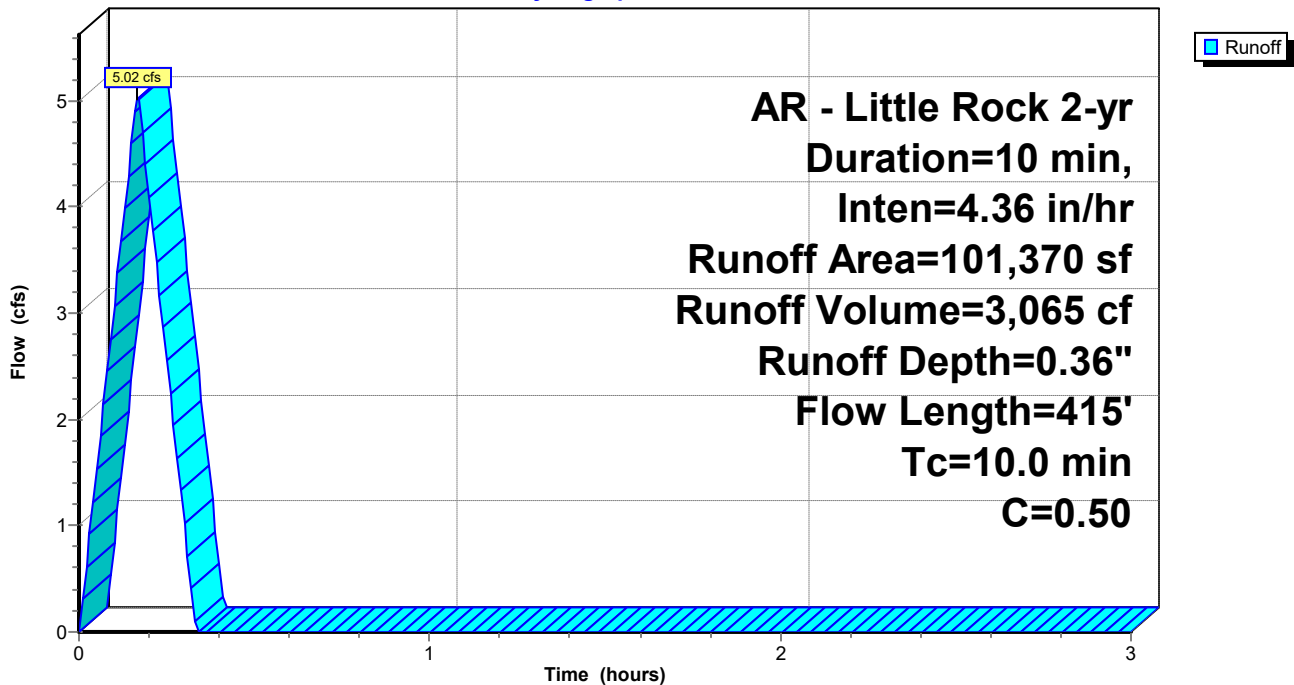

Summerwood Gym 3

AR - Little Rock 2-yr Duration=10 min, Inten=4.36 in/hr

Prepared by Phillip Lewis Engineering

Printed 1/11/2024

HydroCAD® 10.20-2f s/n 12520 © 2022 HydroCAD Software Solutions LLC

Summary for Link Pre-Dev: Pre Dev Runoff

Inflow Area = 208,581 sf, 0.00% Impervious, Inflow Depth = 0.36" for 2-yr event
Inflow = 10.33 cfs @ 0.17 hrs, Volume= 6,307 cf
Primary = 10.33 cfs @ 0.17 hrs, Volume= 6,307 cf, Atten= 0%, Lag= 0.0 min

Primary outflow = Inflow, Time Span= 0.00-3.00 hrs, dt= 0.01 hrs

Link Pre-Dev: Pre Dev Runoff

Hydrograph

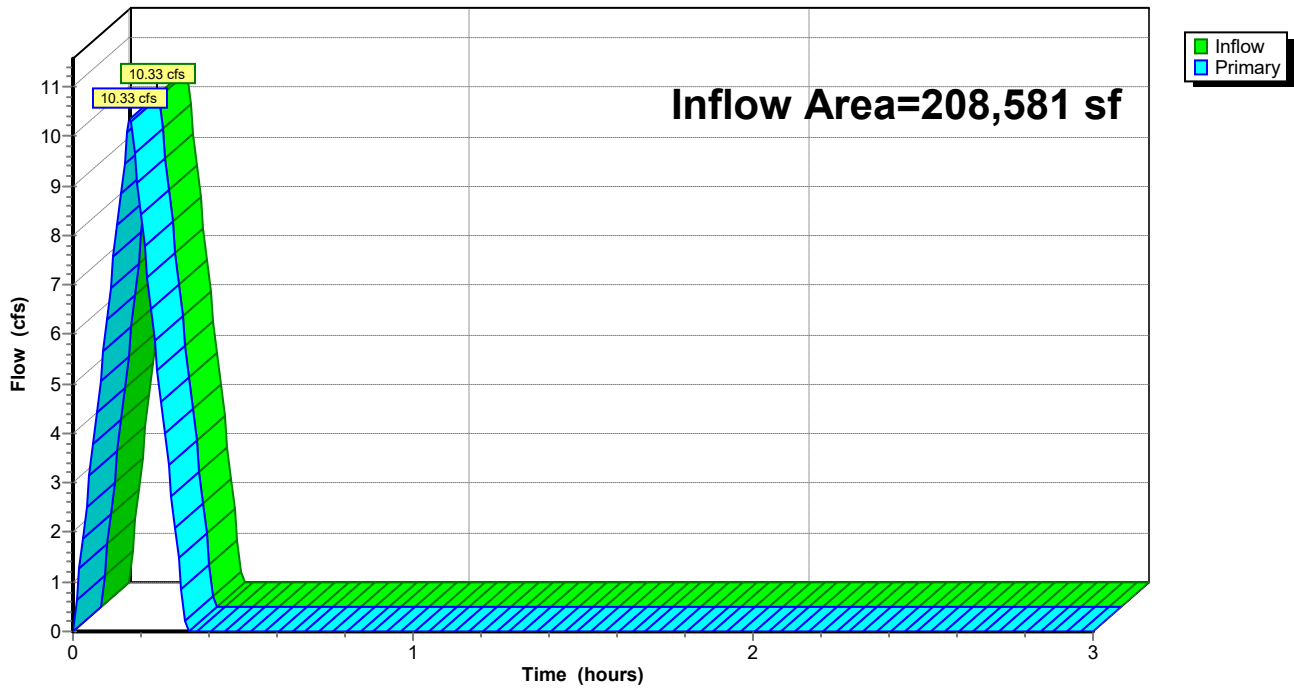

Summerwood Gym 3

Prepared by Phillip Lewis Engineering

HydroCAD® 10.20-2f s/n 12520 © 2022 HydroCAD Software Solutions LLC

AR - Little Rock 5-yr Duration=10 min, Inten=5.17 in/hr

Printed 1/11/2024

Summary for Subcatchment A1: Drainage Basin A1

Runoff = 6.31 cfs @ 0.17 hrs, Volume= 3,849 cf, Depth= 0.43"
 Routed to Link Pre-Dev : Pre Dev Runoff

Runoff by Rational method, Rise/Fall=1.0/1.0 xTc, Time Span= 0.00-3.00 hrs, dt= 0.01 hrs
 AR - Little Rock 5-yr Duration=10 min, Inten=5.17 in/hr

Area (sf)	C	Description
107,211	0.50	Existing Natural Vegetation
107,211		100.00% Pervious Area

Tc (min)	Length (feet)	Slope (ft/ft)	Velocity (ft/sec)	Capacity (cfs)	Description
10.0	415		0.69		Direct Entry, Overland Concentrated Flow (Min)

Subcatchment A1: Drainage Basin A1

Hydrograph

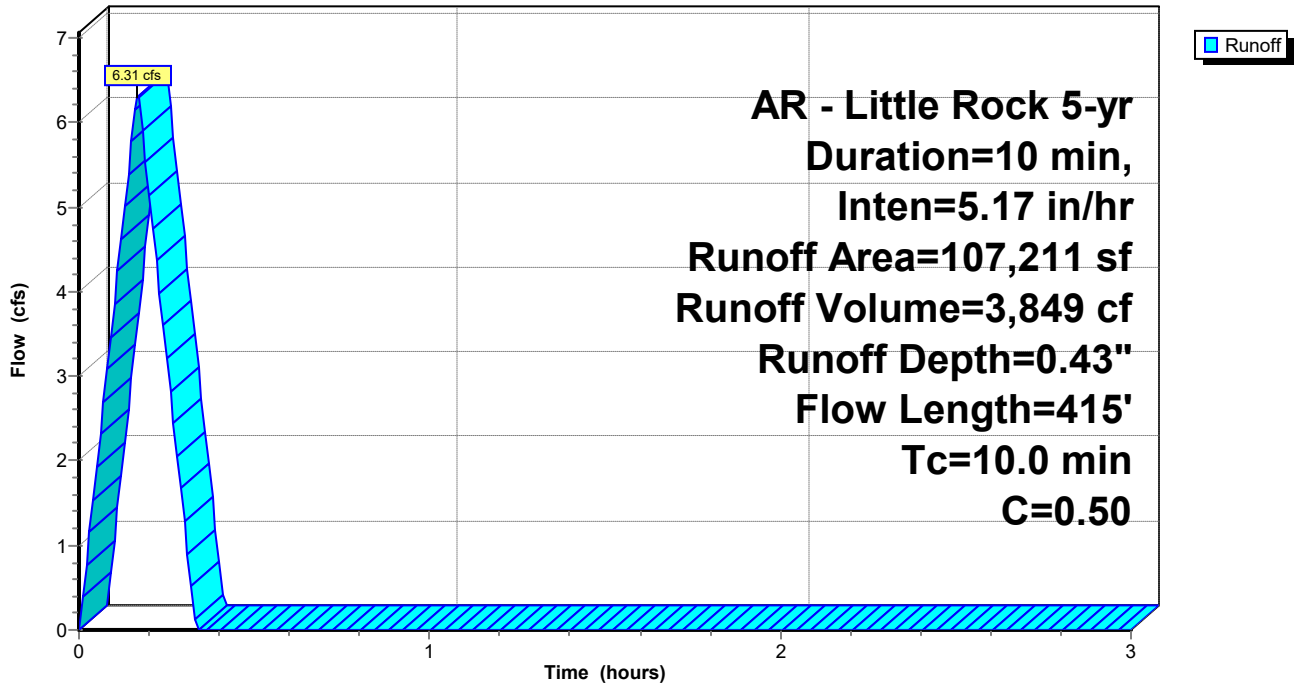

Summerwood Gym 3

AR - Little Rock 5-yr Duration=10 min, Inten=5.17 in/hr

Prepared by Phillip Lewis Engineering

Printed 1/11/2024

HydroCAD® 10.20-2f s/n 12520 © 2022 HydroCAD Software Solutions LLC

Summary for Subcatchment A2: Drainage Basin A2

Runoff = 5.96 cfs @ 0.17 hrs, Volume= 3,639 cf, Depth= 0.43"
Routed to Link Pre-Dev : Pre Dev Runoff

Runoff by Rational method, Rise/Fall=1.0/1.0 xTc, Time Span= 0.00-3.00 hrs, dt= 0.01 hrs
AR - Little Rock 5-yr Duration=10 min, Inten=5.17 in/hr

Area (sf)	C	Description
101,370	0.50	Existing Natural Vegetation
101,370		100.00% Pervious Area

Tc (min)	Length (feet)	Slope (ft/ft)	Velocity (ft/sec)	Capacity (cfs)	Description
10.0	415		0.69		Direct Entry, Overland Concentrated Flow (Min)

Subcatchment A2: Drainage Basin A2

Hydrograph

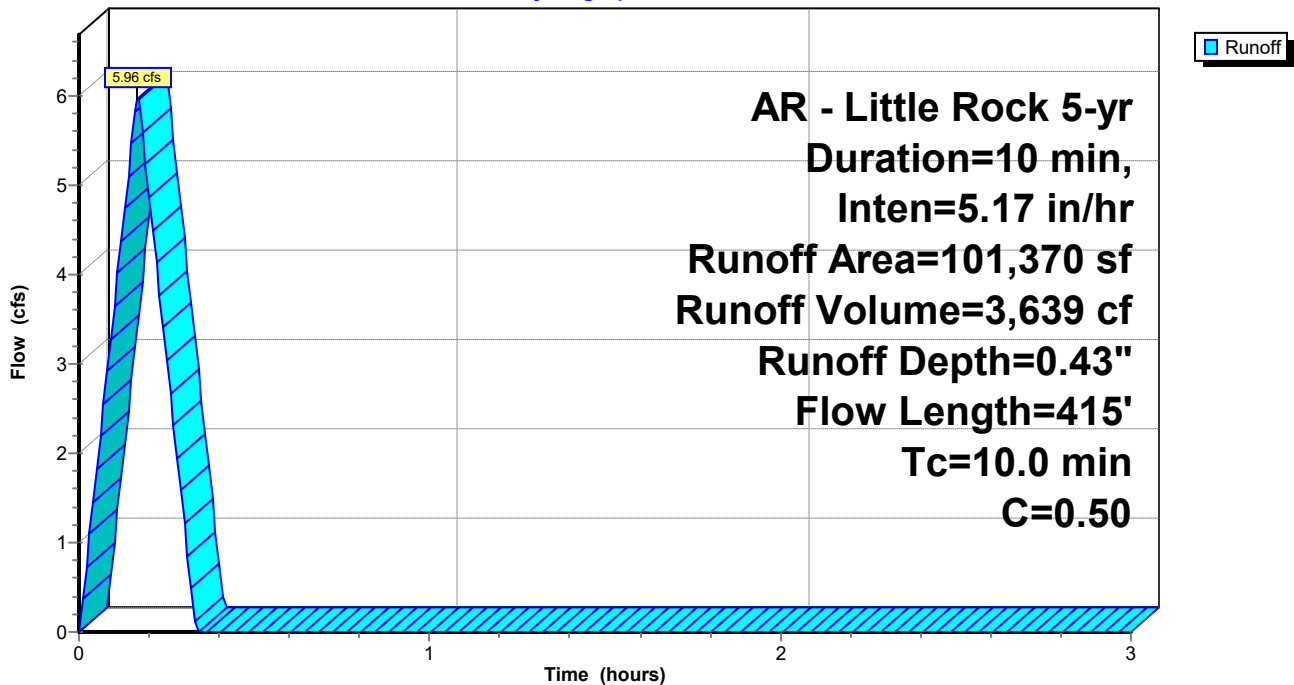

Summerwood Gym 3

AR - Little Rock 5-yr Duration=10 min, Inten=5.17 in/hr

Prepared by Phillip Lewis Engineering

Printed 1/11/2024

HydroCAD® 10.20-2f s/n 12520 © 2022 HydroCAD Software Solutions LLC

Summary for Link Pre-Dev: Pre Dev Runoff

Inflow Area = 208,581 sf, 0.00% Impervious, Inflow Depth = 0.43" for 5-yr event
Inflow = 12.27 cfs @ 0.17 hrs, Volume= 7,489 cf
Primary = 12.27 cfs @ 0.17 hrs, Volume= 7,489 cf, Atten= 0%, Lag= 0.0 min

Primary outflow = Inflow, Time Span= 0.00-3.00 hrs, dt= 0.01 hrs

Link Pre-Dev: Pre Dev Runoff

Hydrograph

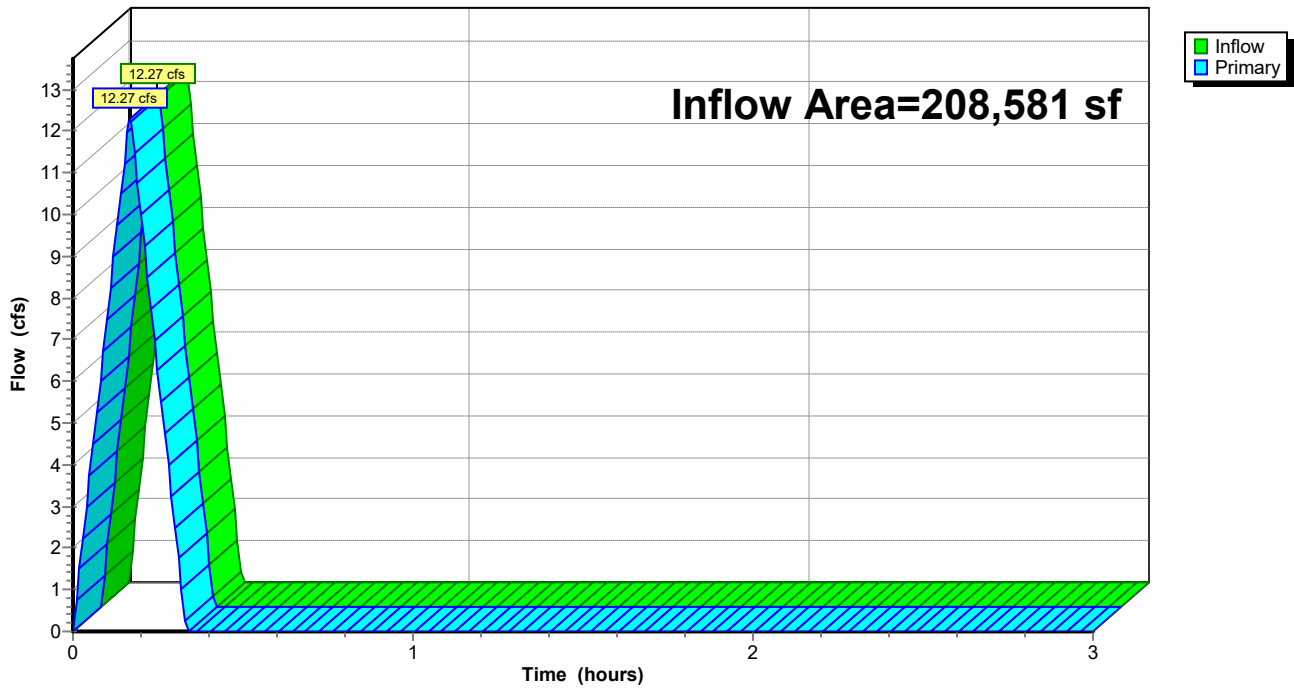

Summerwood Gym 3

Prepared by Phillip Lewis Engineering

HydroCAD® 10.20-2f s/n 12520 © 2022 HydroCAD Software Solutions LLC

AR - Little Rock 10-yr Duration=10 min, Inten=5.83 in/hr

Printed 1/11/2024

Summary for Subcatchment A1: Drainage Basin A1

Runoff = 7.10 cfs @ 0.17 hrs, Volume= 4,336 cf, Depth= 0.49"
Routed to Link Pre-Dev : Pre Dev Runoff

Runoff by Rational method, Rise/Fall=1.0/1.0 xTc, Time Span= 0.00-3.00 hrs, dt= 0.01 hrs
AR - Little Rock 10-yr Duration=10 min, Inten=5.83 in/hr

Area (sf)	C	Description
107,211	0.50	Existing Natural Vegetation
107,211		100.00% Pervious Area

Tc (min)	Length (feet)	Slope (ft/ft)	Velocity (ft/sec)	Capacity (cfs)	Description
10.0	415		0.69		Direct Entry, Overland Concentrated Flow (Min)

Subcatchment A1: Drainage Basin A1

Hydrograph

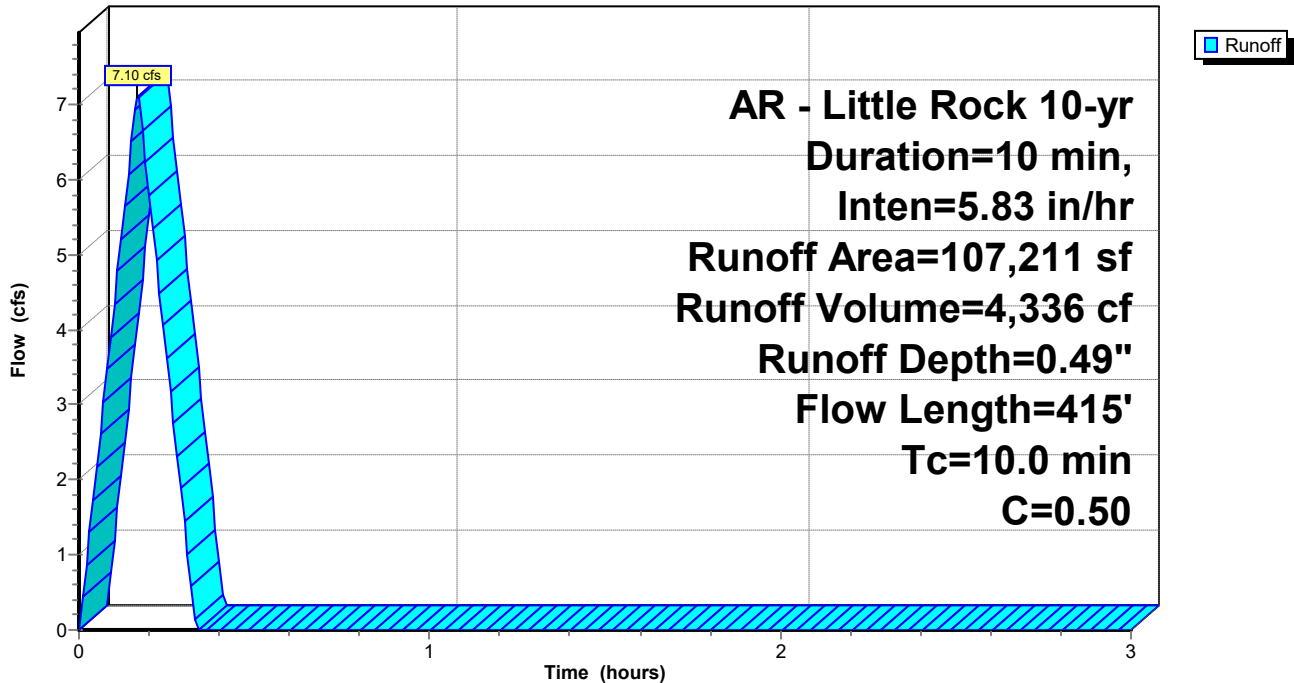

Summerwood Gym 3

Prepared by Phillip Lewis Engineering

HydroCAD® 10.20-2f s/n 12520 © 2022 HydroCAD Software Solutions LLC

AR - Little Rock 10-yr Duration=10 min, Inten=5.83 in/hr

Printed 1/11/2024

Summary for Subcatchment A2: Drainage Basin A2

Runoff = 6.72 cfs @ 0.17 hrs, Volume= 4,100 cf, Depth= 0.49"
Routed to Link Pre-Dev : Pre Dev Runoff

Runoff by Rational method, Rise/Fall=1.0/1.0 xTc, Time Span= 0.00-3.00 hrs, dt= 0.01 hrs
AR - Little Rock 10-yr Duration=10 min, Inten=5.83 in/hr

Area (sf)	C	Description
101,370	0.50	Existing Natural Vegetation
101,370		100.00% Pervious Area

Tc (min)	Length (feet)	Slope (ft/ft)	Velocity (ft/sec)	Capacity (cfs)	Description
10.0	415		0.69		Direct Entry, Overland Concentrated Flow (Min)

Subcatchment A2: Drainage Basin A2

Hydrograph

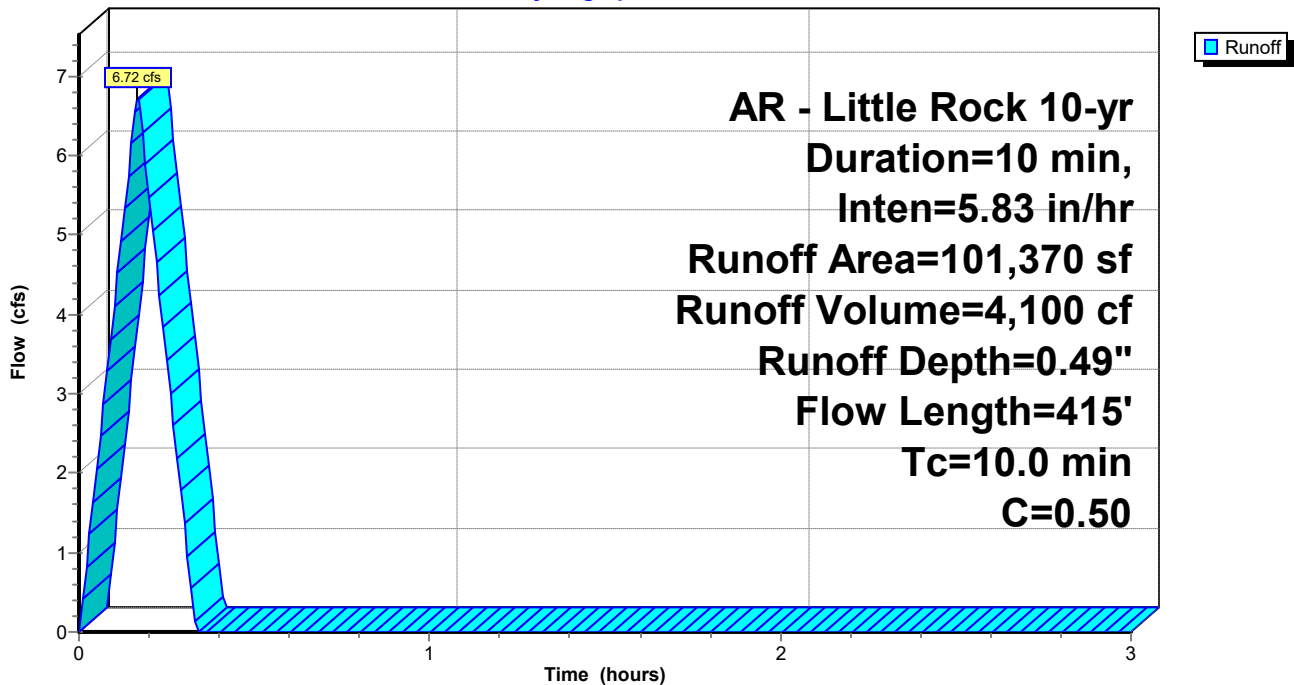

Summerwood Gym 3

Prepared by Phillip Lewis Engineering

HydroCAD® 10.20-2f s/n 12520 © 2022 HydroCAD Software Solutions LLC

AR - Little Rock 10-yr Duration=10 min, Inten=5.83 in/hr

Printed 1/11/2024

Summary for Link Pre-Dev: Pre Dev Runoff

Inflow Area = 208,581 sf, 0.00% Impervious, Inflow Depth = 0.49" for 10-yr event
Inflow = 13.82 cfs @ 0.17 hrs, Volume= 8,435 cf
Primary = 13.82 cfs @ 0.17 hrs, Volume= 8,435 cf, Atten= 0%, Lag= 0.0 min

Primary outflow = Inflow, Time Span= 0.00-3.00 hrs, dt= 0.01 hrs

Link Pre-Dev: Pre Dev Runoff

Hydrograph

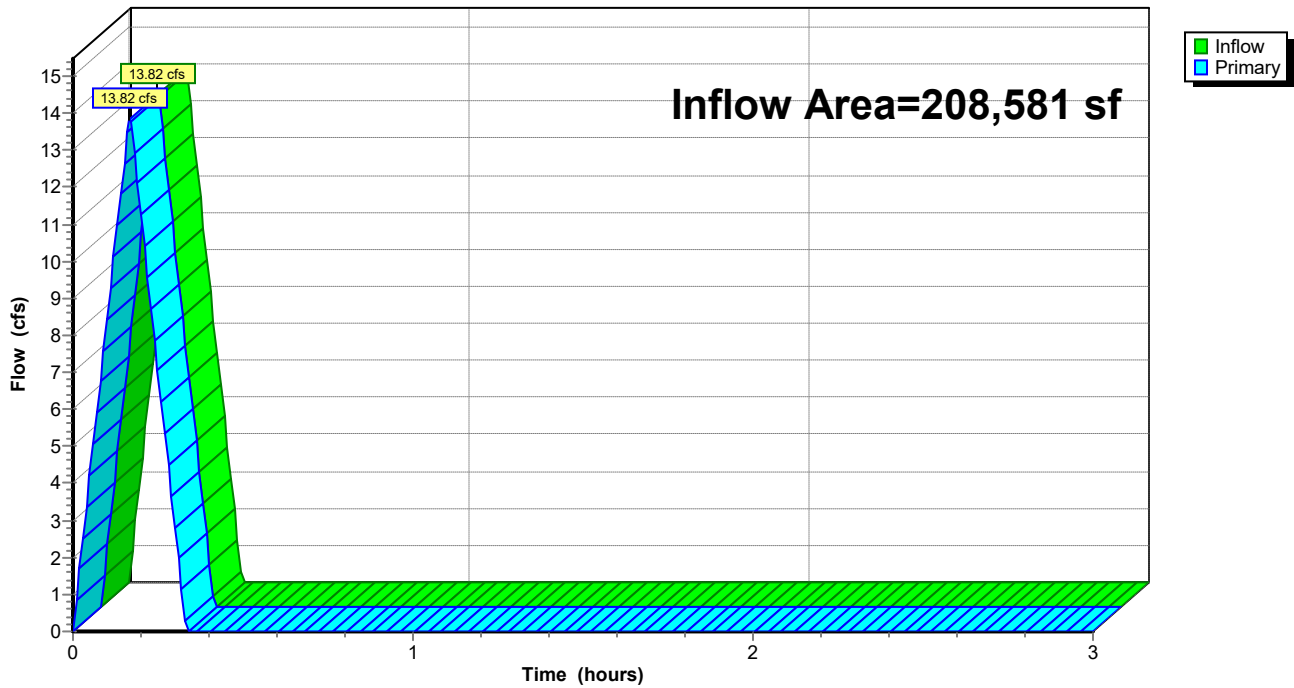

Summerwood Gym 3

Prepared by Phillip Lewis Engineering

HydroCAD® 10.20-2f s/n 12520 © 2022 HydroCAD Software Solutions LLC

AR - Little Rock 25-yr Duration=10 min, Inten=6.72 in/hr

Printed 1/11/2024

Summary for Subcatchment A1: Drainage Basin A1

Runoff = 8.19 cfs @ 0.17 hrs, Volume= 5,001 cf, Depth= 0.56"
 Routed to Link Pre-Dev : Pre Dev Runoff

Runoff by Rational method, Rise/Fall=1.0/1.0 xTc, Time Span= 0.00-3.00 hrs, dt= 0.01 hrs
 AR - Little Rock 25-yr Duration=10 min, Inten=6.72 in/hr

Area (sf)	C	Description
107,211	0.50	Existing Natural Vegetation
107,211		100.00% Pervious Area

Tc (min)	Length (feet)	Slope (ft/ft)	Velocity (ft/sec)	Capacity (cfs)	Description
10.0	415		0.69		Direct Entry, Overland Concentrated Flow (Min)

Subcatchment A1: Drainage Basin A1

Hydrograph

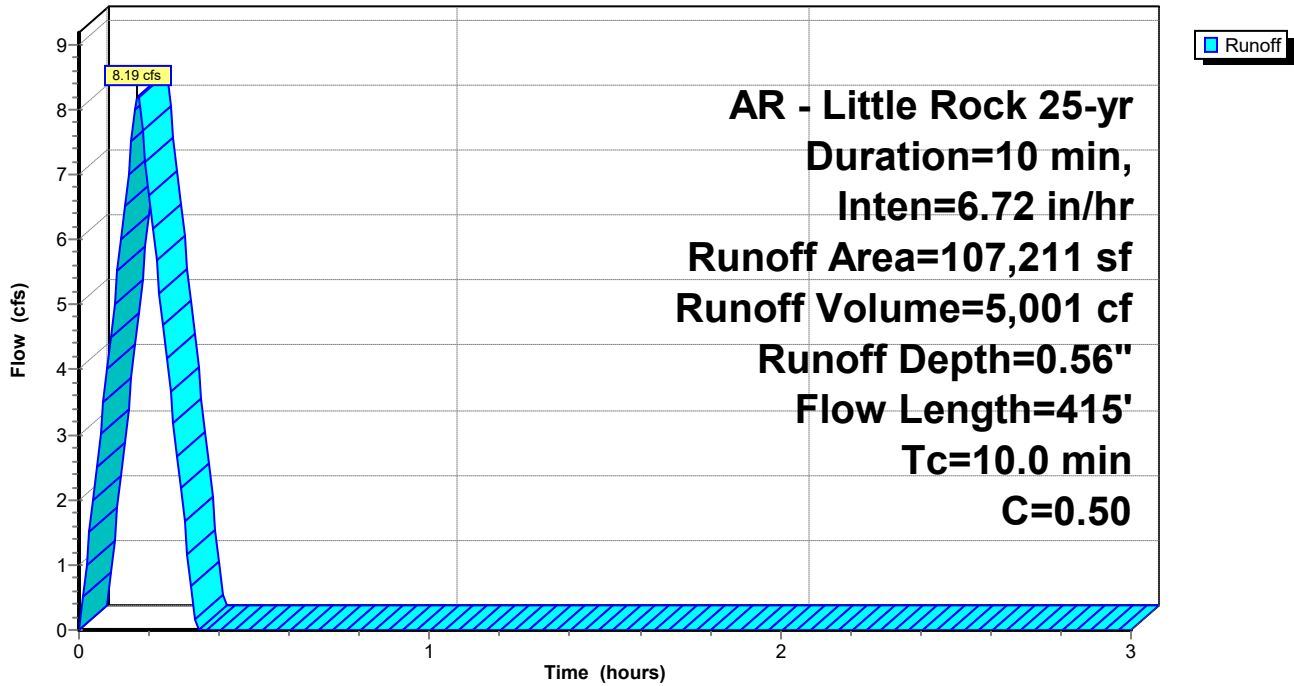

Summerwood Gym 3

Prepared by Phillip Lewis Engineering

HydroCAD® 10.20-2f s/n 12520 © 2022 HydroCAD Software Solutions LLC

AR - Little Rock 25-yr Duration=10 min, Inten=6.72 in/hr

Printed 1/11/2024

Summary for Subcatchment A2: Drainage Basin A2

Runoff = 7.75 cfs @ 0.17 hrs, Volume= 4,729 cf, Depth= 0.56"
Routed to Link Pre-Dev : Pre Dev Runoff

Runoff by Rational method, Rise/Fall=1.0/1.0 xTc, Time Span= 0.00-3.00 hrs, dt= 0.01 hrs
AR - Little Rock 25-yr Duration=10 min, Inten=6.72 in/hr

Area (sf)	C	Description
101,370	0.50	Existing Natural Vegetation
101,370		100.00% Pervious Area

Tc (min)	Length (feet)	Slope (ft/ft)	Velocity (ft/sec)	Capacity (cfs)	Description
10.0	415		0.69		Direct Entry, Overland Concentrated Flow (Min)

Subcatchment A2: Drainage Basin A2

Hydrograph

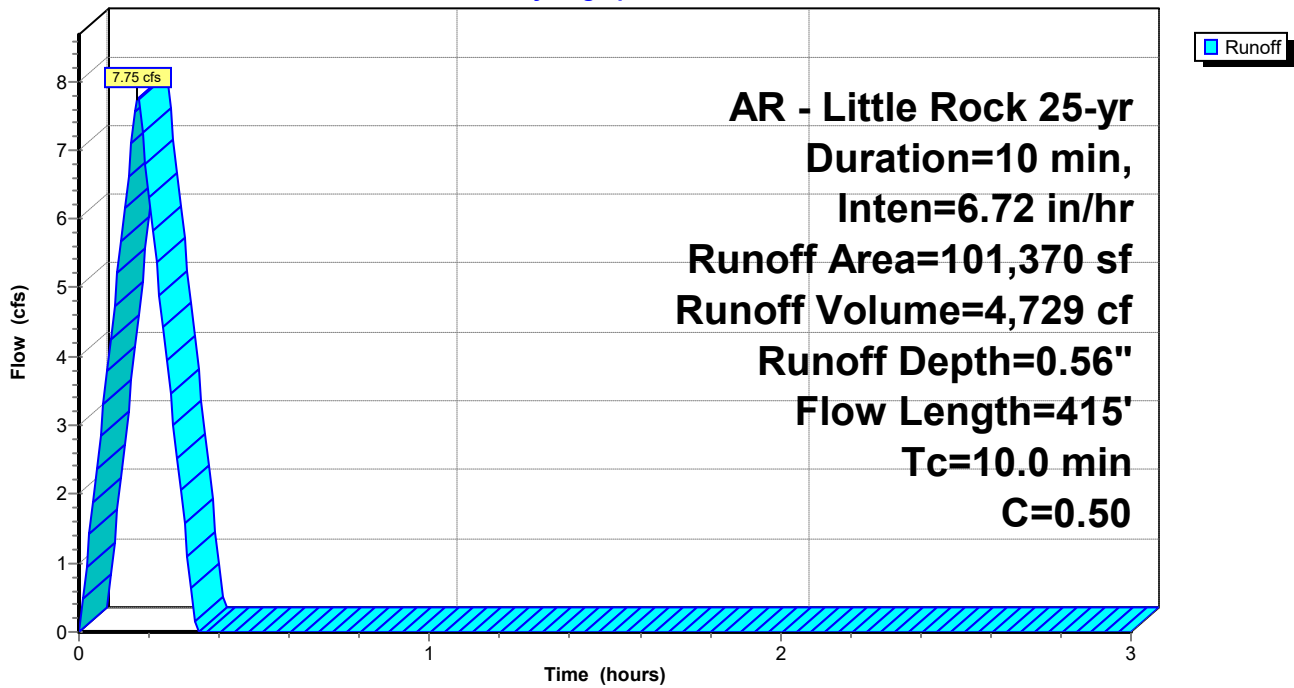

Summerwood Gym 3

Prepared by Phillip Lewis Engineering

HydroCAD® 10.20-2f s/n 12520 © 2022 HydroCAD Software Solutions LLC

AR - Little Rock 25-yr Duration=10 min, Inten=6.72 in/hr

Printed 1/11/2024

Summary for Link Pre-Dev: Pre Dev Runoff

Inflow Area = 208,581 sf, 0.00% Impervious, Inflow Depth = 0.56" for 25-yr event
Inflow = 15.94 cfs @ 0.17 hrs, Volume= 9,730 cf
Primary = 15.94 cfs @ 0.17 hrs, Volume= 9,730 cf, Atten= 0%, Lag= 0.0 min

Primary outflow = Inflow, Time Span= 0.00-3.00 hrs, dt= 0.01 hrs

Link Pre-Dev: Pre Dev Runoff

Hydrograph

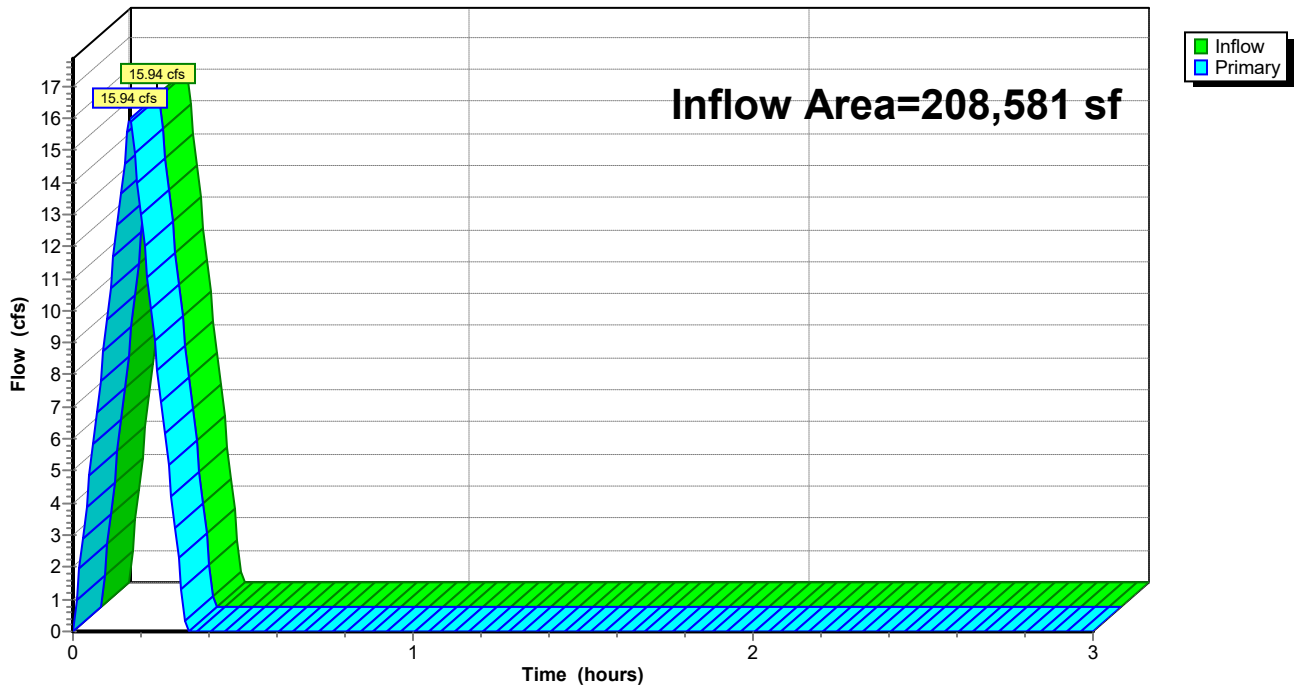

Summerwood Gym 3

Prepared by Phillip Lewis Engineering

HydroCAD® 10.20-2f s/n 12520 © 2022 HydroCAD Software Solutions LLC

AR - Little Rock 100-yr Duration=10 min, Inten=7.98 in/hr

Printed 1/11/2024

Summary for Subcatchment A1: Drainage Basin A1

Runoff = 9.73 cfs @ 0.17 hrs, Volume= 5,939 cf, Depth= 0.66"

Routed to Link Pre-Dev : Pre Dev Runoff

Runoff by Rational method, Rise/Fall=1.0/1.0 xTc, Time Span= 0.00-3.00 hrs, dt= 0.01 hrs

AR - Little Rock 100-yr Duration=10 min, Inten=7.98 in/hr

Area (sf)	C	Description
107,211	0.50	Existing Natural Vegetation
107,211		100.00% Pervious Area

Tc (min)	Length (feet)	Slope (ft/ft)	Velocity (ft/sec)	Capacity (cfs)	Description
10.0	415		0.69		Direct Entry, Overland Concentrated Flow (Min)

Subcatchment A1: Drainage Basin A1

Hydrograph

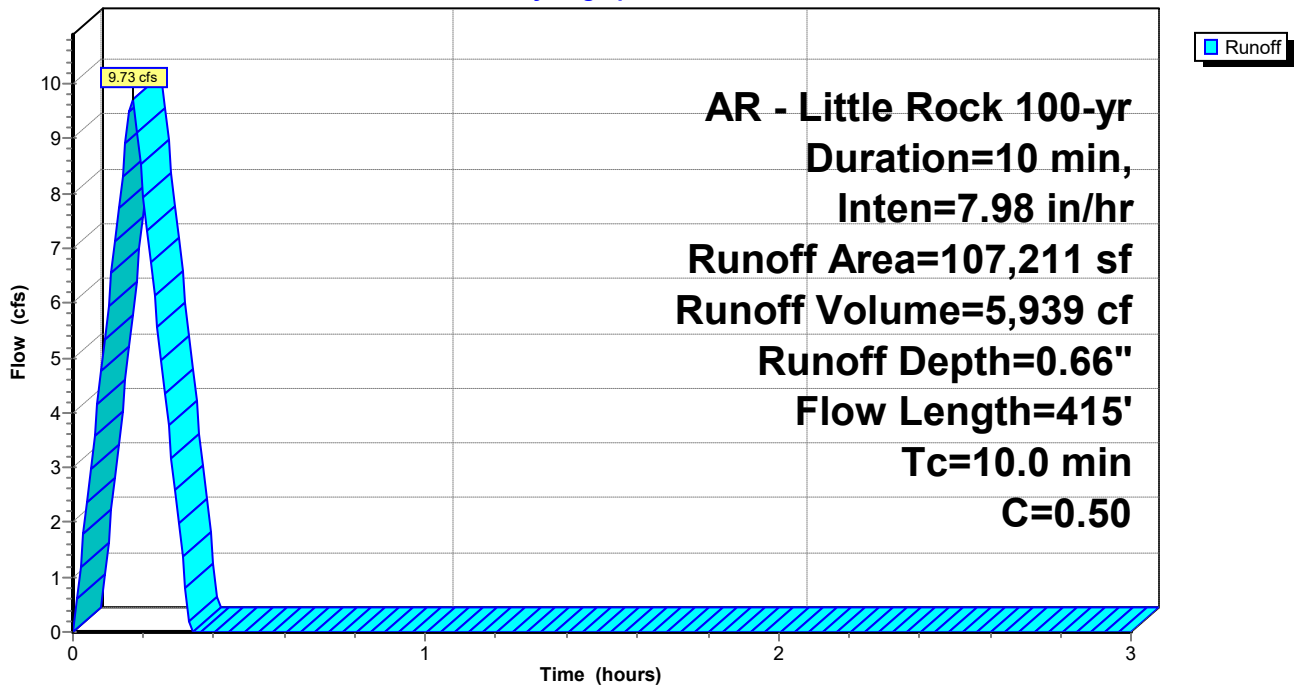

Summerwood Gym 3

AR - Little Rock 100-yr Duration=10 min, Inten=7.98 in/hr

Prepared by Phillip Lewis Engineering

Printed 1/11/2024

HydroCAD® 10.20-2f s/n 12520 © 2022 HydroCAD Software Solutions LLC

Summary for Subcatchment A2: Drainage Basin A2

Runoff = 9.20 cfs @ 0.17 hrs, Volume= 5,615 cf, Depth= 0.66"
Routed to Link Pre-Dev : Pre Dev Runoff

Runoff by Rational method, Rise/Fall=1.0/1.0 xTc, Time Span= 0.00-3.00 hrs, dt= 0.01 hrs
AR - Little Rock 100-yr Duration=10 min, Inten=7.98 in/hr

Area (sf)	C	Description
101,370	0.50	Existing Natural Vegetation
101,370		100.00% Pervious Area

Tc (min)	Length (feet)	Slope (ft/ft)	Velocity (ft/sec)	Capacity (cfs)	Description
10.0	415		0.69		Direct Entry, Overland Concentrated Flow (Min)

Subcatchment A2: Drainage Basin A2

Hydrograph

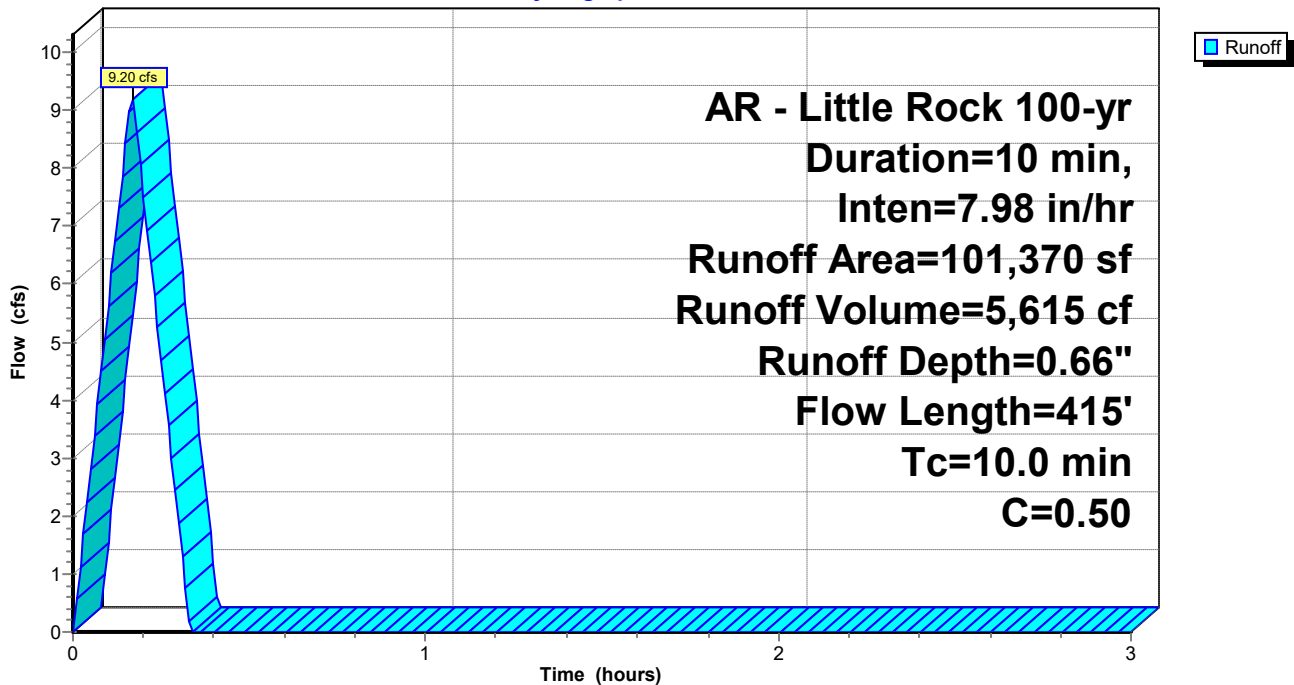

Summerwood Gym 3

AR - Little Rock 100-yr Duration=10 min, Inten=7.98 in/hr

Prepared by Phillip Lewis Engineering

Printed 1/11/2024

HydroCAD® 10.20-2f s/n 12520 © 2022 HydroCAD Software Solutions LLC

Summary for Link Pre-Dev: Pre Dev Runoff

Inflow Area = 208,581 sf, 0.00% Impervious, Inflow Depth = 0.66" for 100-yr event
Inflow = 18.93 cfs @ 0.17 hrs, Volume= 11,554 cf
Primary = 18.93 cfs @ 0.17 hrs, Volume= 11,554 cf, Atten= 0%, Lag= 0.0 min

Primary outflow = Inflow, Time Span= 0.00-3.00 hrs, dt= 0.01 hrs

Link Pre-Dev: Pre Dev Runoff

Hydrograph

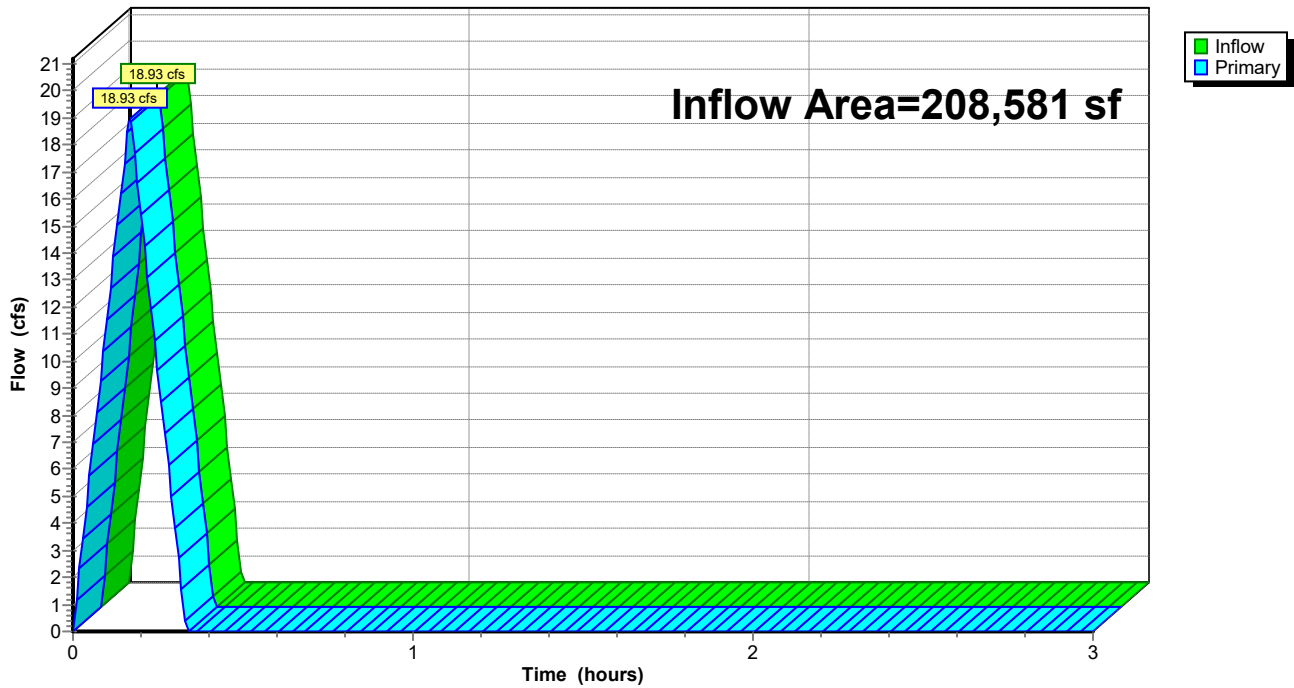

POST DEVELOPMENT HYDROGRAPHS

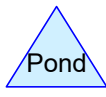
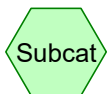
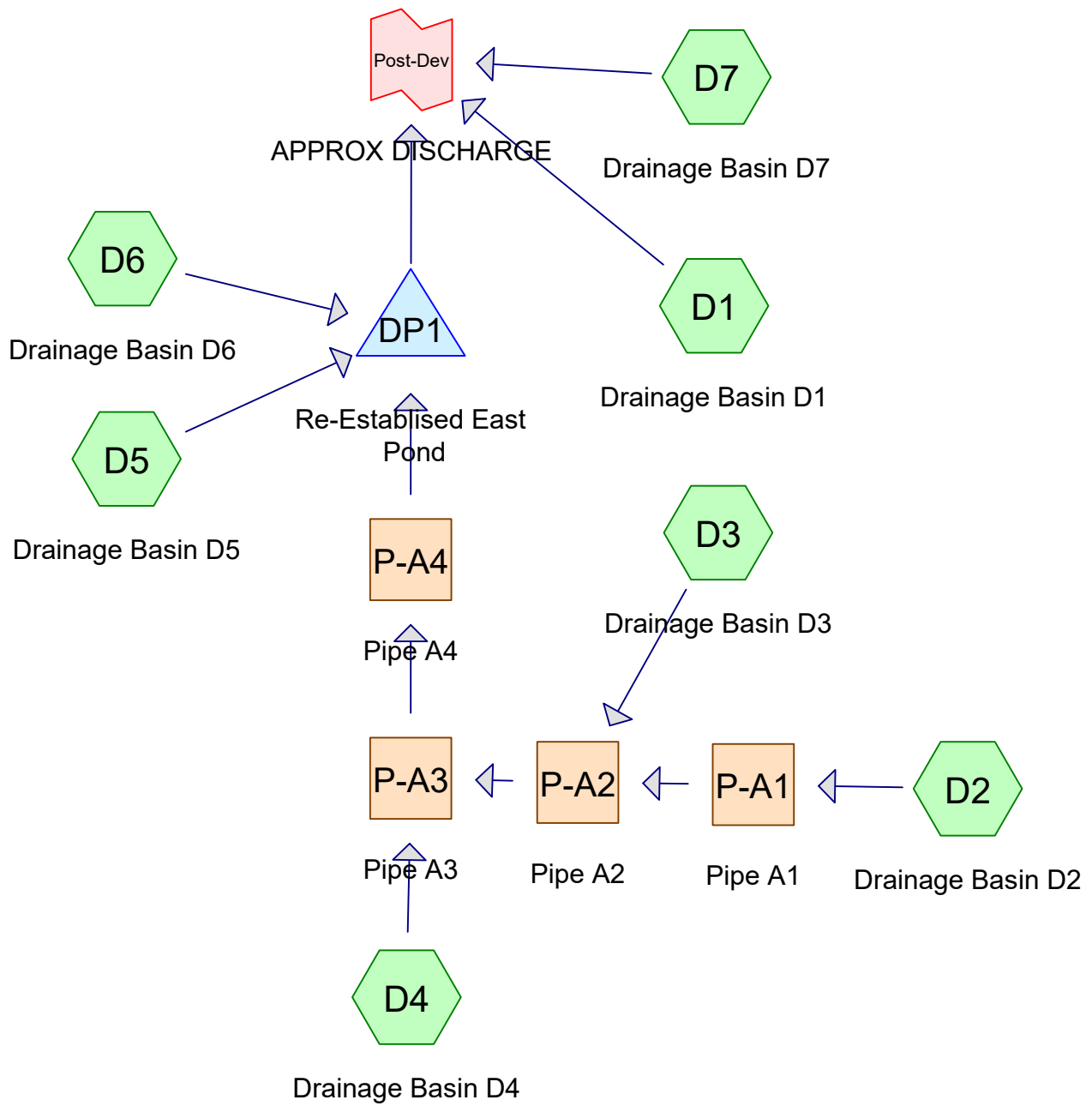

Routing Diagram for Summerwood Gym 3 2-yr
 Prepared by Phillip Lewis Engineering, Printed 1/11/2024
 HydroCAD® 10.20-2f s/n 12520 © 2022 HydroCAD Software Solutions LLC

Summary for Subcatchment D1: Drainage Basin D1

Runoff = 4.32 cfs @ 0.09 hrs, Volume= 2,586 cf, Depth= 0.64"
 Routed to Link Post-Dev : APPROX DISCHARGE

Runoff by Rational method, Rise/Fall=1.0/1.0 xTc, Time Span= 0.00-3.00 hrs, dt= 0.01 hrs
 AR - Little Rock 2-yr Duration=10 min, Inten=4.36 in/hr

Area (sf)	C	Description
3,421	0.40	Sod Yard
45,236	0.92	Road, Drives, Sidewalks
48,657	0.88	Weighted Average
48,657		100.00% Pervious Area

Tc (min)	Length (feet)	Slope (ft/ft)	Velocity (ft/sec)	Capacity (cfs)	Description
5.0					Direct Entry, Overland Concentrated Flow (Min)

Subcatchment D1: Drainage Basin D1

Hydrograph

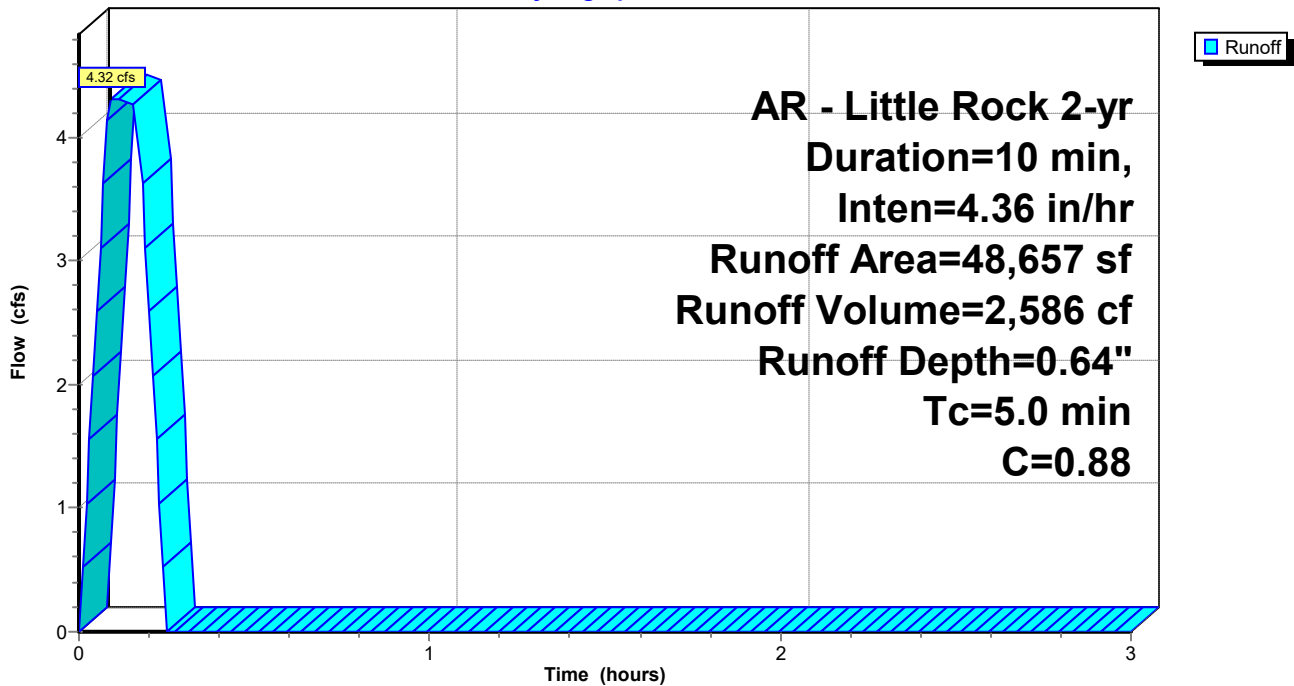

Summerwood Gym 3 2-yr

Prepared by Phillip Lewis Engineering

HydroCAD® 10.20-2f s/n 12520 © 2022 HydroCAD Software Solutions LLC

AR - Little Rock 2-yr Duration=10 min, Inten=4.36 in/hr

Printed 1/11/2024

Summary for Subcatchment D2: Drainage Basin D2

Runoff = 1.85 cfs @ 0.09 hrs, Volume= 1,106 cf, Depth= 0.54"

Routed to Reach P-A1 : Pipe A1

Runoff by Rational method, Rise/Fall=1.0/1.0 xTc, Time Span= 0.00-3.00 hrs, dt= 0.01 hrs

AR - Little Rock 2-yr Duration=10 min, Inten=4.36 in/hr

Area (sf)	C	Description
8,845	0.45	Rip Rap Embankment
15,566	0.92	Roof, Drives, Sidewalks
24,411	0.75	Weighted Average
24,411		100.00% Pervious Area

Tc (min)	Length (feet)	Slope (ft/ft)	Velocity (ft/sec)	Capacity (cfs)	Description
5.0	415		1.38		Direct Entry, Overland Concentrated Flow (Min)

Subcatchment D2: Drainage Basin D2

Hydrograph

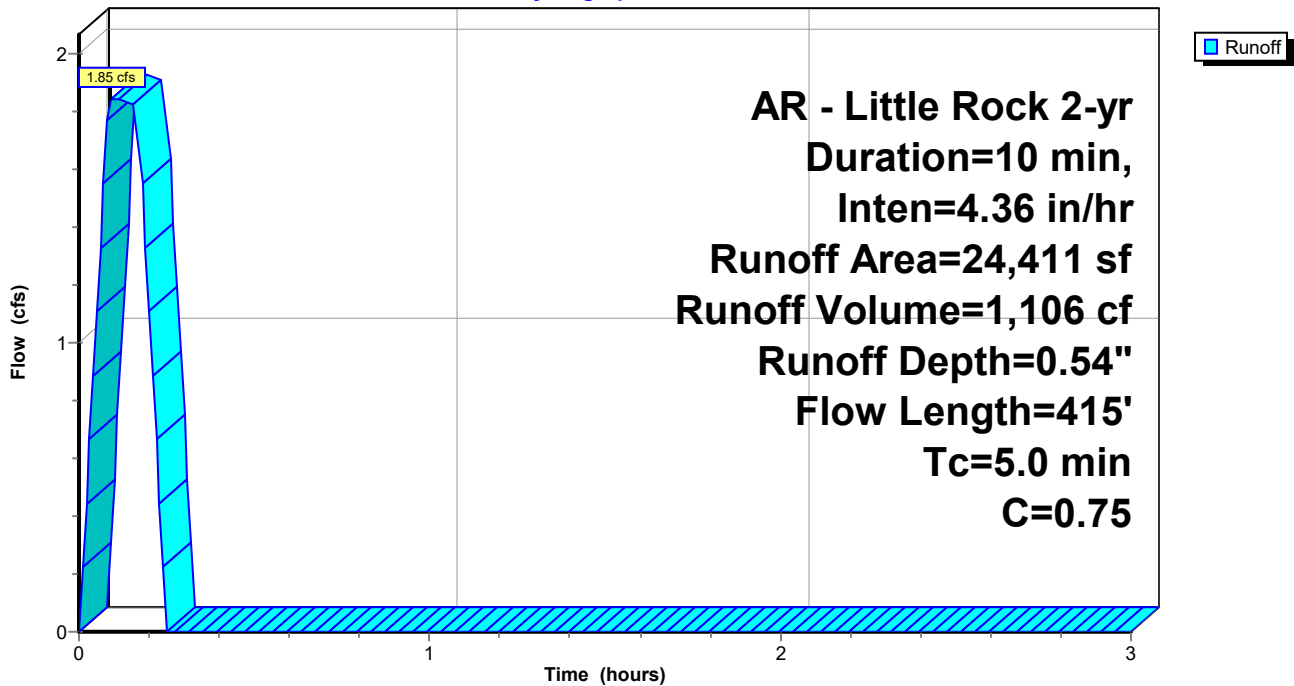

Summerwood Gym 3 2-yr

Prepared by Phillip Lewis Engineering

HydroCAD® 10.20-2f s/n 12520 © 2022 HydroCAD Software Solutions LLC

AR - Little Rock 2-yr Duration=10 min, Inten=4.36 in/hr

Printed 1/11/2024

Summary for Subcatchment D3: Drainage Basin D3

Runoff = 1.36 cfs @ 0.09 hrs, Volume= 813 cf, Depth= 0.64"

Routed to Reach P-A2 : Pipe A2

Runoff by Rational method, Rise/Fall=1.0/1.0 xTc, Time Span= 0.00-3.00 hrs, dt= 0.01 hrs

AR - Little Rock 2-yr Duration=10 min, Inten=4.36 in/hr

Area (sf)	C	Description
1,065	0.40	Sod Yard
14,229	0.92	Paving, Sidewalks
15,294	0.88	Weighted Average
15,294		100.00% Pervious Area

Tc (min)	Length (feet)	Slope (ft/ft)	Velocity (ft/sec)	Capacity (cfs)	Description
5.0	415		1.38		Direct Entry, Overland Concentrated Flow (Min)

Subcatchment D3: Drainage Basin D3

Hydrograph

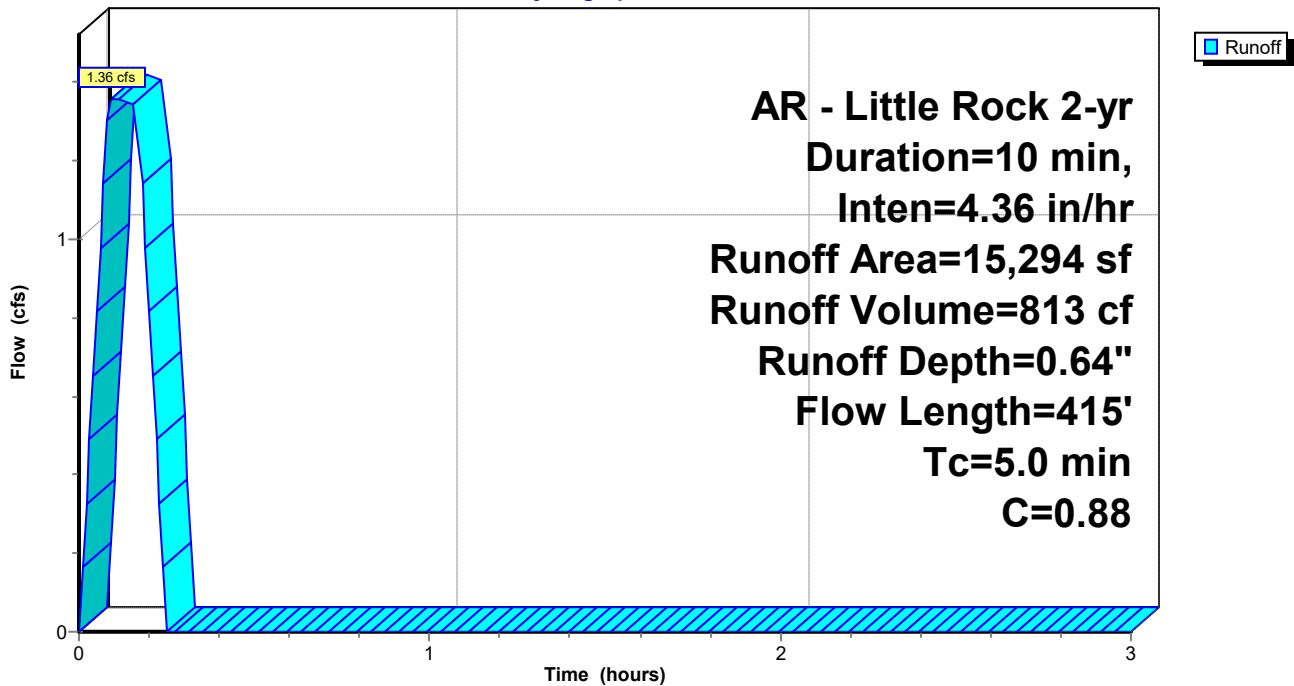

Summerwood Gym 3 2-yr

AR - Little Rock 2-yr Duration=10 min, Inten=4.36 in/hr

Prepared by Phillip Lewis Engineering

Printed 1/11/2024

HydroCAD® 10.20-2f s/n 12520 © 2022 HydroCAD Software Solutions LLC

Summary for Subcatchment D4: Drainage Basin D4

Runoff = 1.91 cfs @ 0.17 hrs, Volume= 1,163 cf, Depth= 0.44"

Routed to Reach P-A3 : Pipe A3

Runoff by Rational method, Rise/Fall=1.0/1.0 xTc, Time Span= 0.00-3.00 hrs, dt= 0.01 hrs

AR - Little Rock 2-yr Duration=10 min, Inten=4.36 in/hr

Area (sf)	C	Description
20,032	0.40	
12,031	0.92	
32,063	0.60	Weighted Average
32,063		100.00% Pervious Area

Tc (min)	Length (feet)	Slope (ft/ft)	Velocity (ft/sec)	Capacity (cfs)	Description
10.0	415		0.69		Direct Entry, Overland Concentrated Flow (Min)

Subcatchment D4: Drainage Basin D4

Hydrograph

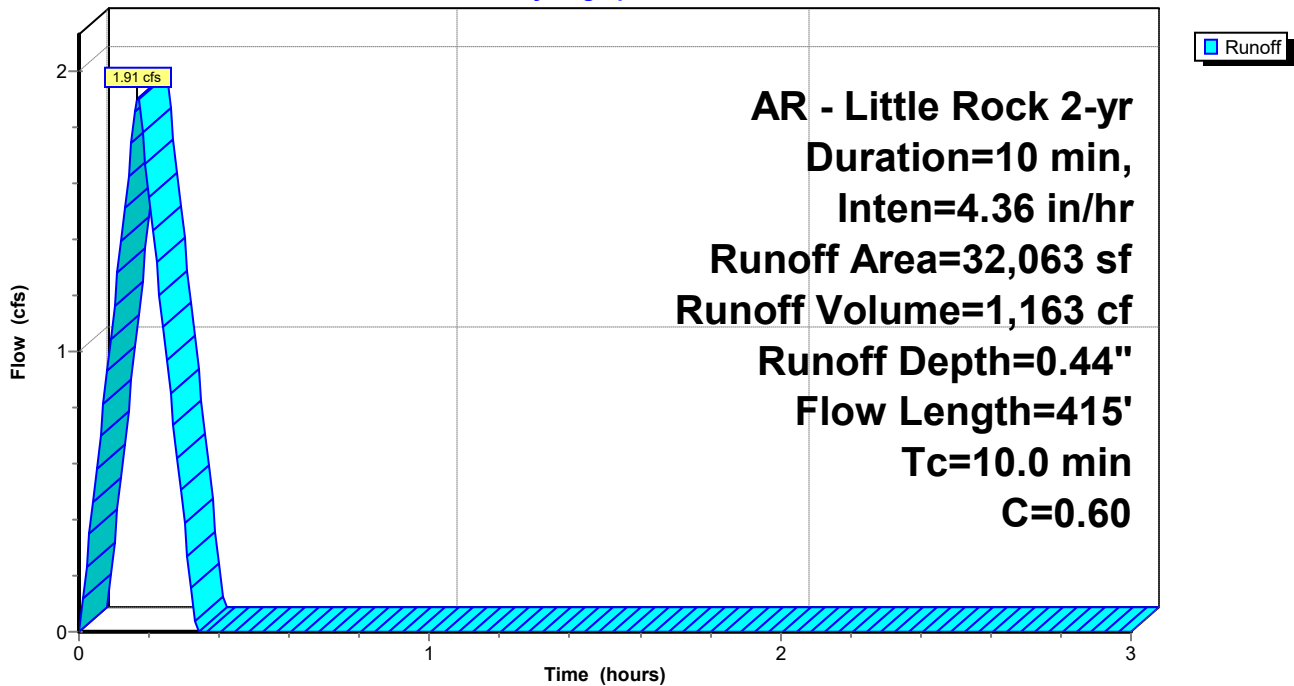

Summerwood Gym 3 2-yr

Prepared by Phillip Lewis Engineering

HydroCAD® 10.20-2f s/n 12520 © 2022 HydroCAD Software Solutions LLC

AR - Little Rock 2-yr Duration=10 min, Inten=4.36 in/hr

Printed 1/11/2024

Summary for Subcatchment D5: Drainage Basin D5

Runoff = 2.77 cfs @ 0.09 hrs, Volume= 1,660 cf, Depth= 0.48"
Routed to Pond DP1 : Re-Established East Pond

Runoff by Rational method, Rise/Fall=1.0/1.0 xTc, Time Span= 0.00-3.00 hrs, dt= 0.01 hrs
AR - Little Rock 2-yr Duration=10 min, Inten=4.36 in/hr

Area (sf)	C	Description
21,201	0.40	Sod Yard, Natural Vegetation
20,437	0.92	Paving, Sidewalks
41,638	0.66	Weighted Average
41,638		100.00% Pervious Area

Tc (min)	Length (feet)	Slope (ft/ft)	Velocity (ft/sec)	Capacity (cfs)	Description
5.0					Direct Entry, Overland Concentrated Flow (Min)

Subcatchment D5: Drainage Basin D5

Hydrograph

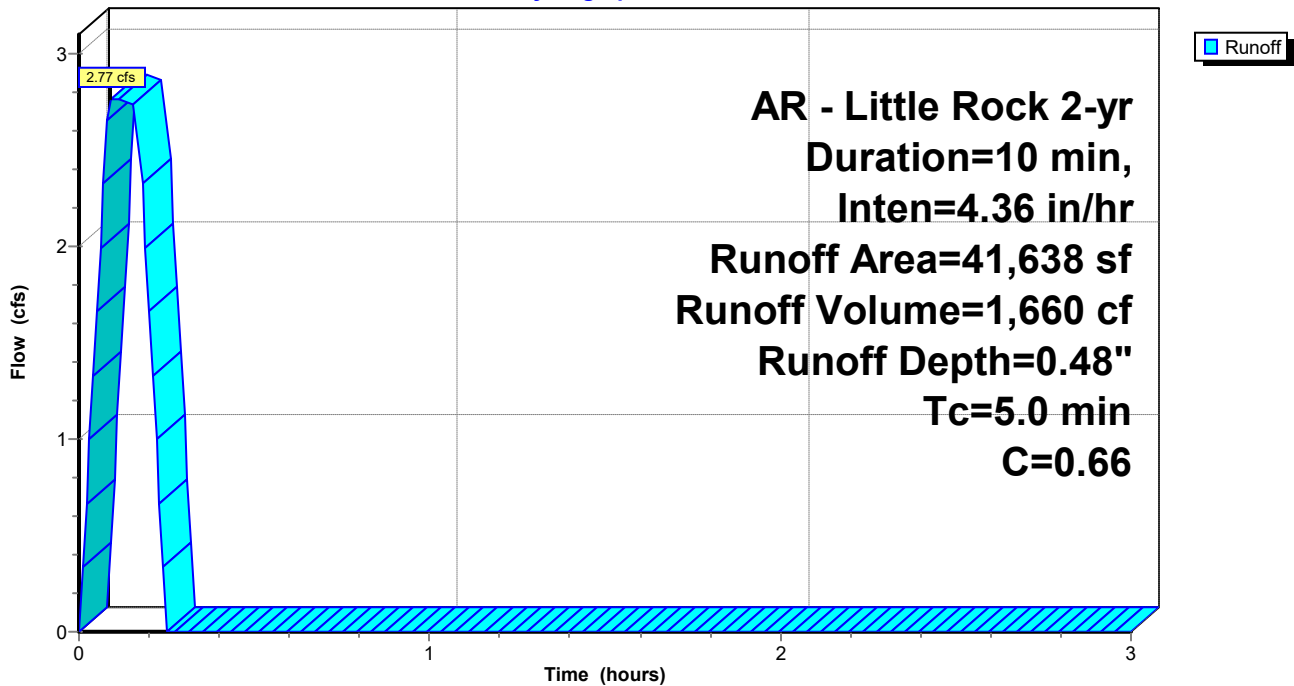

Summerwood Gym 3 2-yr

AR - Little Rock 2-yr Duration=10 min, Inten=4.36 in/hr

Prepared by Phillip Lewis Engineering

Printed 1/11/2024

HydroCAD® 10.20-2f s/n 12520 © 2022 HydroCAD Software Solutions LLC

Summary for Subcatchment D6: Drainage Basin D6

Runoff = 1.77 cfs @ 0.09 hrs, Volume= 1,062 cf, Depth= 0.67"
Routed to Pond DP1 : Re-Established East Pond

Runoff by Rational method, Rise/Fall=1.0/1.0 xTc, Time Span= 0.00-3.00 hrs, dt= 0.01 hrs
AR - Little Rock 2-yr Duration=10 min, Inten=4.36 in/hr

Area (sf)	C	Description
19,108	0.92	Roof
19,108		100.00% Pervious Area

Tc (min)	Length (feet)	Slope (ft/ft)	Velocity (ft/sec)	Capacity (cfs)	Description
5.0					Direct Entry, Overland Concentrated Flow (Min)

Subcatchment D6: Drainage Basin D6

Hydrograph

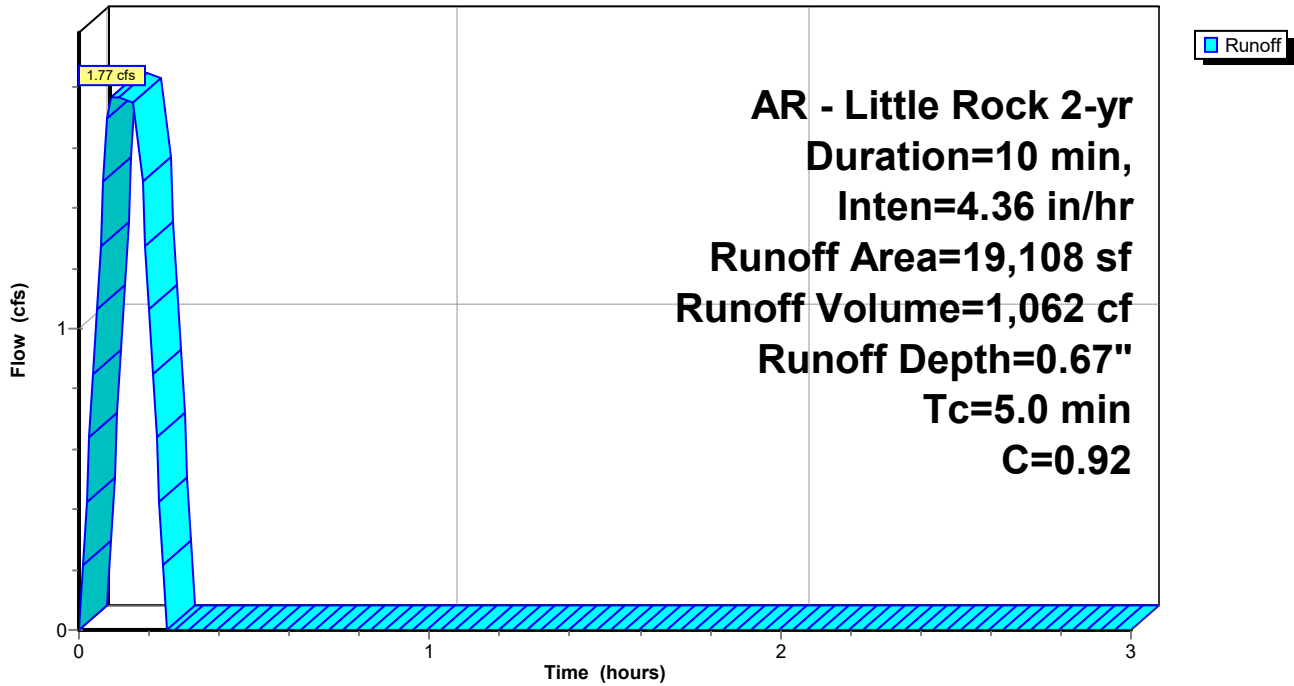

Summerwood Gym 3 2-yr

Prepared by Phillip Lewis Engineering

HydroCAD® 10.20-2f s/n 12520 © 2022 HydroCAD Software Solutions LLC

AR - Little Rock 2-yr Duration=10 min, Inten=4.36 in/hr

Printed 1/11/2024

Summary for Subcatchment D7: Drainage Basin D7

Runoff = 1.34 cfs @ 0.09 hrs, Volume= 800 cf, Depth= 0.38"
Routed to Link Post-Dev : APPROX DISCHARGE

Runoff by Rational method, Rise/Fall=1.0/1.0 xTc, Time Span= 0.00-3.00 hrs, dt= 0.01 hrs
AR - Little Rock 2-yr Duration=10 min, Inten=4.36 in/hr

Area (sf)	C	Description
18,798	0.40	Sod Yard, Natural Vegetation
6,197	0.92	Paving, Sidewalks
24,995	0.53	Weighted Average
24,995		100.00% Pervious Area

Tc (min)	Length (feet)	Slope (ft/ft)	Velocity (ft/sec)	Capacity (cfs)	Description
5.0					Direct Entry, Overland Concentrated Flow (Min)

Subcatchment D7: Drainage Basin D7

Hydrograph

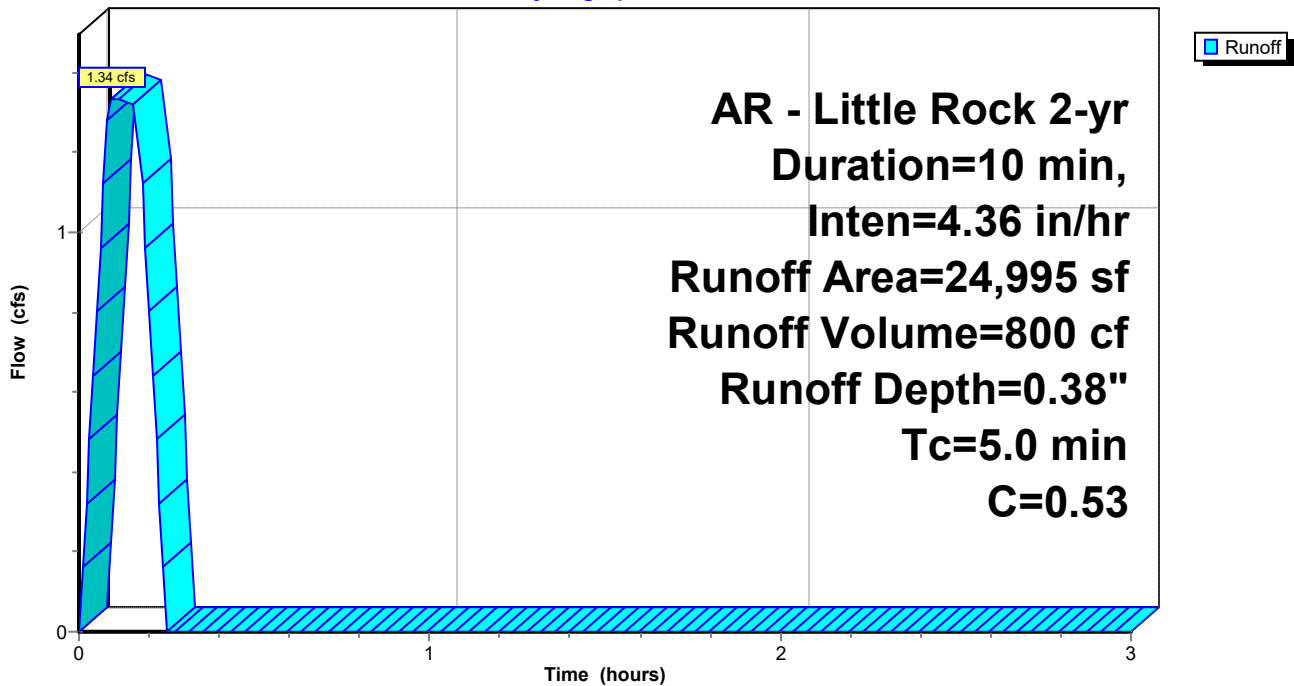

Summerwood Gym 3 2-yr

Prepared by Phillip Lewis Engineering

HydroCAD® 10.20-2f s/n 12520 © 2022 HydroCAD Software Solutions LLC

AR - Little Rock 2-yr Duration=10 min, Inten=4.36 in/hr

Printed 1/11/2024

Summary for Reach P-A1: Pipe A1

Inflow Area = 24,411 sf, 0.00% Impervious, Inflow Depth = 0.54" for 2-yr event
Inflow = 1.85 cfs @ 0.09 hrs, Volume= 1,106 cf
Outflow = 1.85 cfs @ 0.11 hrs, Volume= 1,106 cf, Atten= 0%, Lag= 1.2 min
Routed to Reach P-A2 : Pipe A2

Routing by Stor-Ind+Trans method, Time Span= 0.00-3.00 hrs, dt= 0.01 hrs
Max. Velocity= 6.38 fps, Min. Travel Time= 0.1 min
Avg. Velocity= 4.53 fps, Avg. Travel Time= 0.2 min

Peak Storage= 15 cf @ 0.09 hrs
Average Depth at Peak Storage= 0.33' , Surface Width= 1.24'
Bank-Full Depth= 1.50' Flow Area= 1.8 sf, Capacity= 17.28 cfs

18.0" Round Pipe
n= 0.013 Corrugated PE, smooth interior
Length= 51.0' Slope= 0.0271 '/'
Inlet Invert= 408.33', Outlet Invert= 406.95'

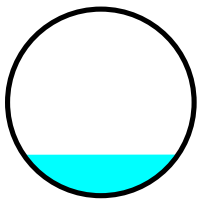

Reach P-A1: Pipe A1

Hydrograph

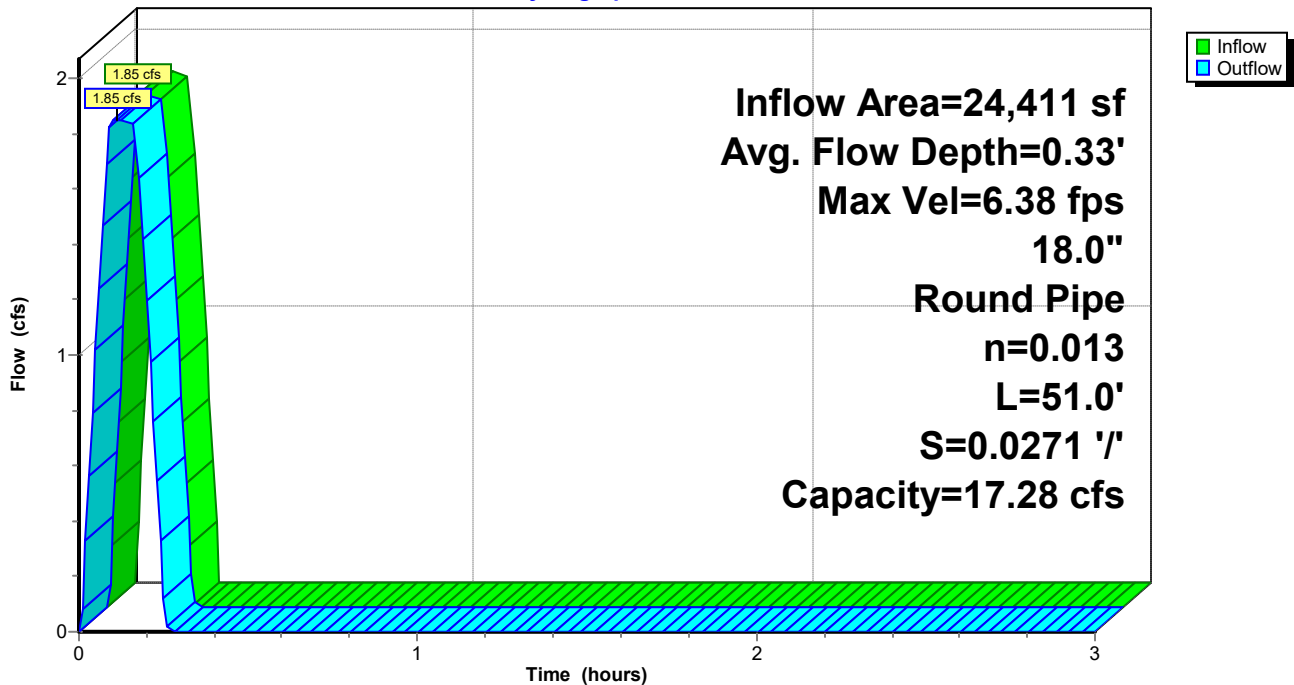

Reach P-A1: Pipe A1

Stage-Discharge

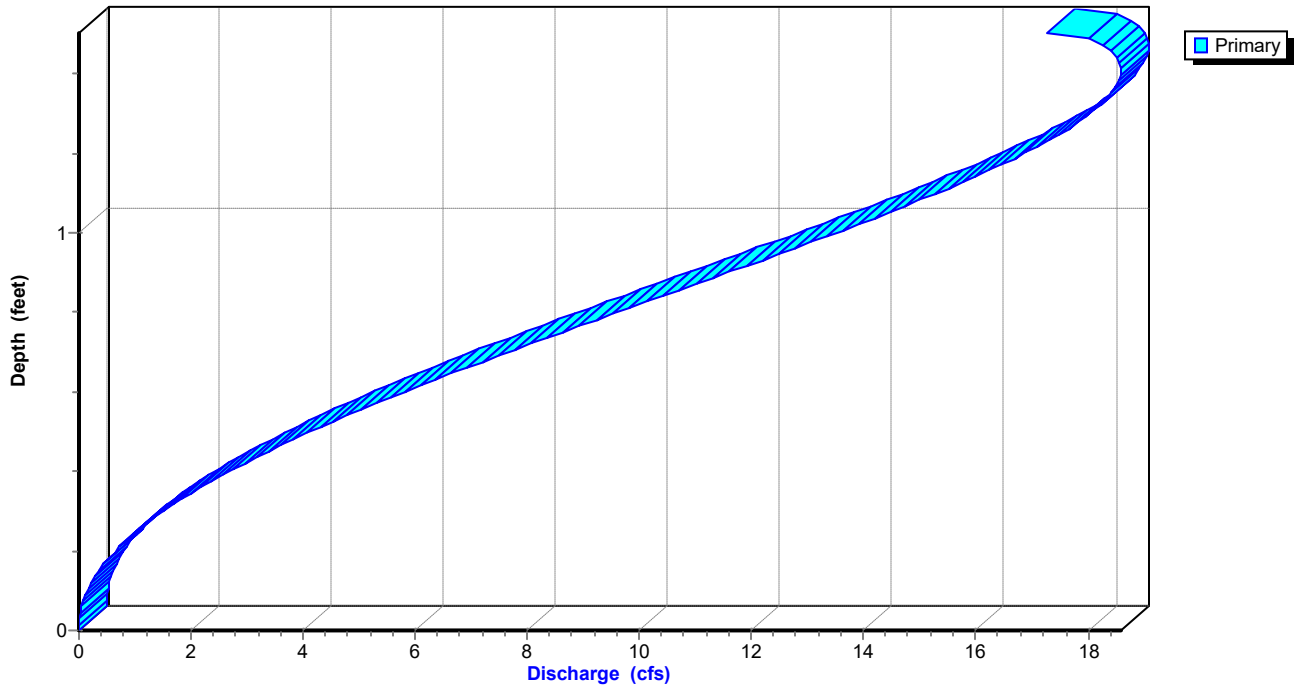

Summerwood Gym 3 2-yr*AR - Little Rock 2-yr Duration=10 min, Inten=4.36 in/hr*

Prepared by Phillip Lewis Engineering

Printed 1/11/2024

HydroCAD® 10.20-2f s/n 12520 © 2022 HydroCAD Software Solutions LLC

Stage-Area-Storage for Reach P-A1: Pipe A1

Elevation (feet)	End-Area (sq-ft)	Storage (cubic-feet)	Elevation (feet)	End-Area (sq-ft)	Storage (cubic-feet)
408.33	0.0	0	409.37	1.3	67
408.35	0.0	0	409.39	1.3	68
408.37	0.0	1	409.41	1.4	69
408.39	0.0	1	409.43	1.4	71
408.41	0.0	2	409.45	1.4	72
408.43	0.1	3	409.47	1.4	73
408.45	0.1	3	409.49	1.5	75
408.47	0.1	4	409.51	1.5	76
408.49	0.1	5	409.53	1.5	77
408.51	0.1	6	409.55	1.5	78
408.53	0.1	7	409.57	1.6	80
408.55	0.2	8	409.59	1.6	81
408.57	0.2	9	409.61	1.6	82
408.59	0.2	10	409.63	1.6	83
408.61	0.2	12	409.65	1.6	84
408.63	0.3	13	409.67	1.7	85
408.65	0.3	14	409.69	1.7	86
408.67	0.3	15	409.71	1.7	87
408.69	0.3	17	409.73	1.7	88
408.71	0.4	18	409.75	1.7	88
408.73	0.4	19	409.77	1.7	89
408.75	0.4	21	409.79	1.8	89
408.77	0.4	22	409.81	1.8	90
408.79	0.5	23	409.83	1.8	90
408.81	0.5	25			
408.83	0.5	26			
408.85	0.5	28			
408.87	0.6	29			
408.89	0.6	31			
408.91	0.6	32			
408.93	0.7	34			
408.95	0.7	35			
408.97	0.7	37			
408.99	0.7	38			
409.01	0.8	40			
409.03	0.8	41			
409.05	0.8	43			
409.07	0.9	44			
409.09	0.9	46			
409.11	0.9	47			
409.13	1.0	49			
409.15	1.0	50			
409.17	1.0	52			
409.19	1.0	53			
409.21	1.1	55			
409.23	1.1	56			
409.25	1.1	58			
409.27	1.2	59			
409.29	1.2	61			
409.31	1.2	62			
409.33	1.3	64			
409.35	1.3	65			

Summerwood Gym 3 2-yr

Prepared by Phillip Lewis Engineering

HydroCAD® 10.20-2f s/n 12520 © 2022 HydroCAD Software Solutions LLC

AR - Little Rock 2-yr Duration=10 min, Inten=4.36 in/hr

Printed 1/11/2024

Summary for Reach P-A2: Pipe A2

Inflow Area = 39,705 sf, 0.00% Impervious, Inflow Depth = 0.58" for 2-yr event
Inflow = 3.20 cfs @ 0.11 hrs, Volume= 1,919 cf
Outflow = 3.20 cfs @ 0.16 hrs, Volume= 1,919 cf, Atten= 0%, Lag= 3.0 min
Routed to Reach P-A3 : Pipe A3

Routing by Stor-Ind+Trans method, Time Span= 0.00-3.00 hrs, dt= 0.01 hrs
Max. Velocity= 5.73 fps, Min. Travel Time= 0.5 min
Avg. Velocity = 2.32 fps, Avg. Travel Time= 1.3 min

Peak Storage= 99 cf @ 0.16 hrs
Average Depth at Peak Storage= 0.53' , Surface Width= 1.43'
Bank-Full Depth= 1.50' Flow Area= 1.8 sf, Capacity= 11.95 cfs

18.0" Round Pipe
n= 0.013 Corrugated PE, smooth interior
Length= 177.0' Slope= 0.0129 '/'
Inlet Invert= 406.85', Outlet Invert= 404.56'

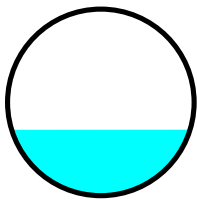

Reach P-A2: Pipe A2

Hydrograph

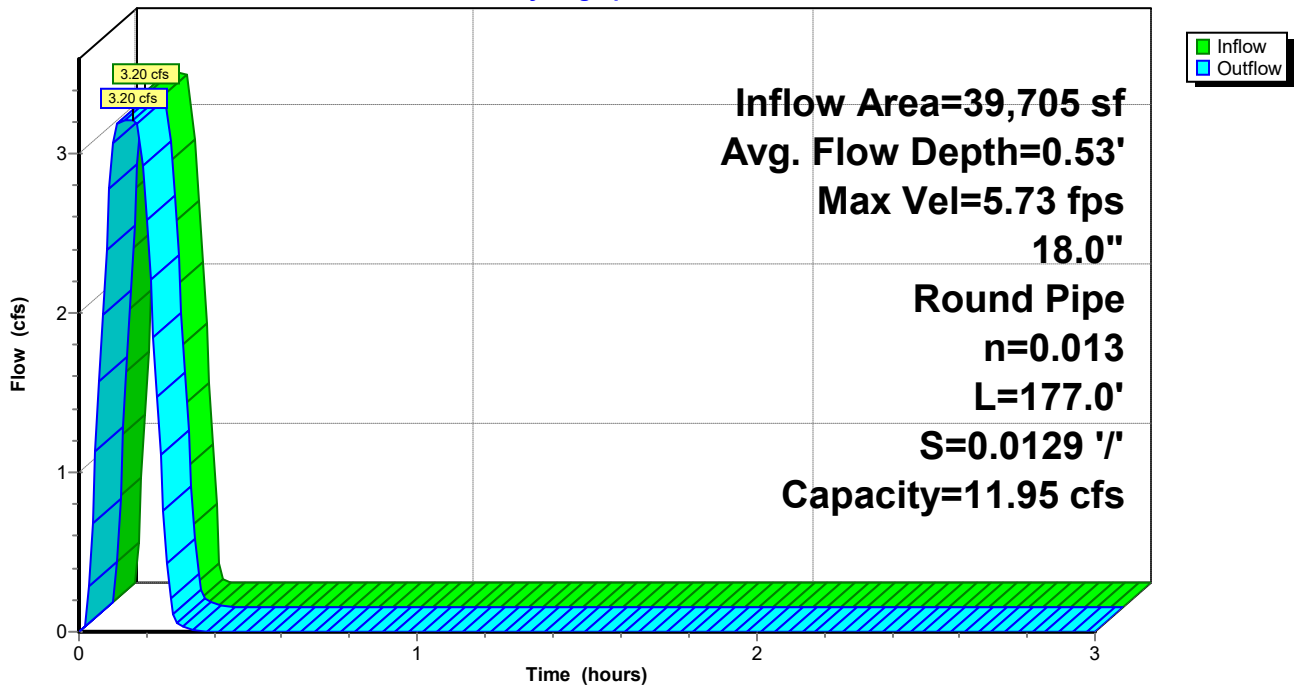

Reach P-A2: Pipe A2

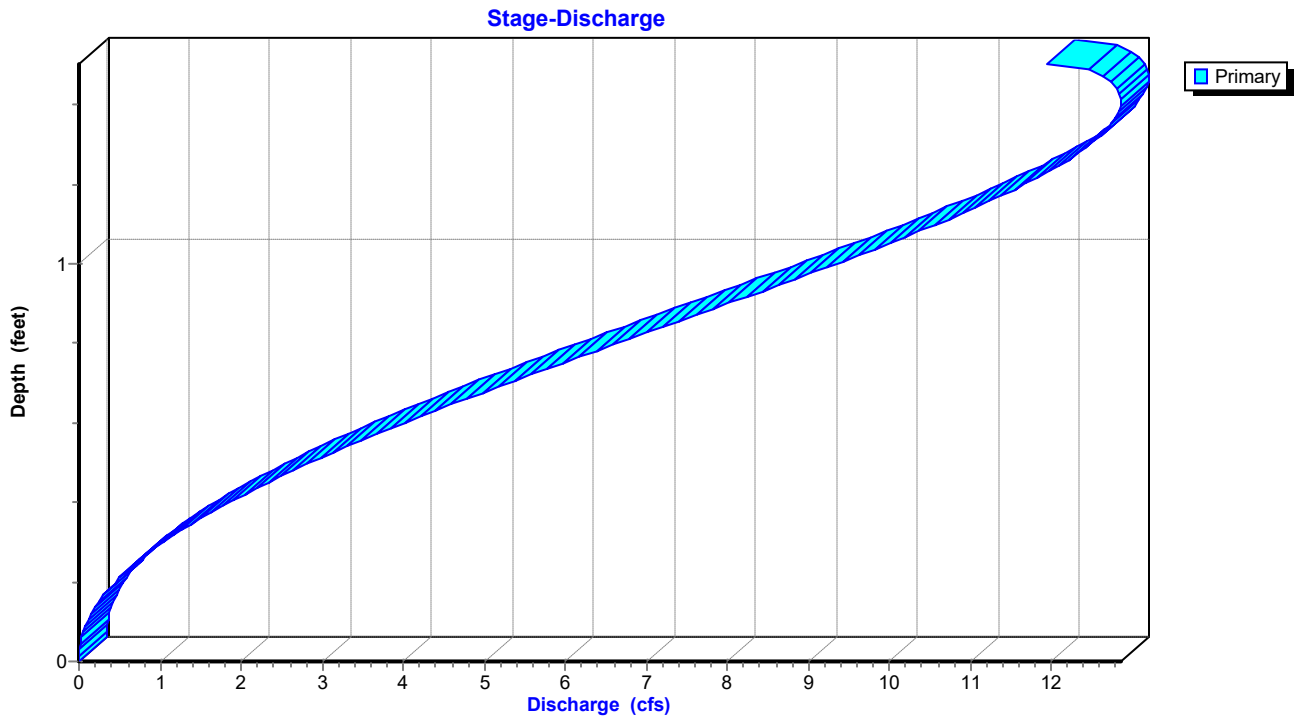

Summerwood Gym 3 2-yr*AR - Little Rock 2-yr Duration=10 min, Inten=4.36 in/hr*

Prepared by Phillip Lewis Engineering

Printed 1/11/2024

HydroCAD® 10.20-2f s/n 12520 © 2022 HydroCAD Software Solutions LLC

Stage-Area-Storage for Reach P-A2: Pipe A2

Elevation (feet)	End-Area (sq-ft)	Storage (cubic-feet)	Elevation (feet)	End-Area (sq-ft)	Storage (cubic-feet)
406.85	0.0	0	407.89	1.3	231
406.87	0.0	1	407.91	1.3	236
406.89	0.0	2	407.93	1.4	241
406.91	0.0	4	407.95	1.4	246
406.93	0.0	6	407.97	1.4	250
406.95	0.1	9	407.99	1.4	255
406.97	0.1	12	408.01	1.5	260
406.99	0.1	15	408.03	1.5	264
407.01	0.1	18	408.05	1.5	268
407.03	0.1	21	408.07	1.5	272
407.05	0.1	25	408.09	1.6	277
407.07	0.2	28	408.11	1.6	280
407.09	0.2	32	408.13	1.6	284
407.11	0.2	36	408.15	1.6	288
407.13	0.2	40	408.17	1.6	292
407.15	0.3	45	408.19	1.7	295
407.17	0.3	49	408.21	1.7	298
407.19	0.3	53	408.23	1.7	301
407.21	0.3	58	408.25	1.7	304
407.23	0.4	62	408.27	1.7	306
407.25	0.4	67	408.29	1.7	309
407.27	0.4	72	408.31	1.8	310
407.29	0.4	76	408.33	1.8	312
407.31	0.5	81	408.35	1.8	313
407.33	0.5	86			
407.35	0.5	91			
407.37	0.5	96			
407.39	0.6	101			
407.41	0.6	106			
407.43	0.6	112			
407.45	0.7	117			
407.47	0.7	122			
407.49	0.7	127			
407.51	0.7	133			
407.53	0.8	138			
407.55	0.8	143			
407.57	0.8	148			
407.59	0.9	154			
407.61	0.9	159			
407.63	0.9	164			
407.65	1.0	170			
407.67	1.0	175			
407.69	1.0	180			
407.71	1.0	185			
407.73	1.1	191			
407.75	1.1	196			
407.77	1.1	201			
407.79	1.2	206			
407.81	1.2	211			
407.83	1.2	216			
407.85	1.3	222			
407.87	1.3	226			

Summerwood Gym 3 2-yr

Prepared by Phillip Lewis Engineering

HydroCAD® 10.20-2f s/n 12520 © 2022 HydroCAD Software Solutions LLC

AR - Little Rock 2-yr Duration=10 min, Inten=4.36 in/hr

Printed 1/11/2024

Summary for Reach P-A3: Pipe A3

Inflow Area = 71,768 sf, 0.00% Impervious, Inflow Depth = 0.52" for 2-yr event
Inflow = 5.11 cfs @ 0.17 hrs, Volume= 3,082 cf
Outflow = 5.07 cfs @ 0.17 hrs, Volume= 3,082 cf, Atten= 1%, Lag= 0.3 min
Routed to Reach P-A4 : Pipe A4

Routing by Stor-Ind+Trans method, Time Span= 0.00-3.00 hrs, dt= 0.01 hrs
Max. Velocity= 8.64 fps, Min. Travel Time= 0.2 min
Avg. Velocity= 3.61 fps, Avg. Travel Time= 0.5 min

Peak Storage= 70 cf @ 0.17 hrs
Average Depth at Peak Storage= 0.55' , Surface Width= 1.45'
Bank-Full Depth= 1.50' Flow Area= 1.8 sf, Capacity= 17.65 cfs

18.0" Round Pipe
n= 0.013 Corrugated PE, smooth interior
Length= 118.0' Slope= 0.0282 '/'
Inlet Invert= 404.46', Outlet Invert= 401.13'

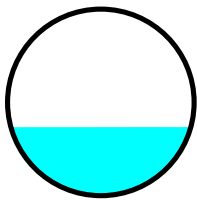

Reach P-A3: Pipe A3

Hydrograph

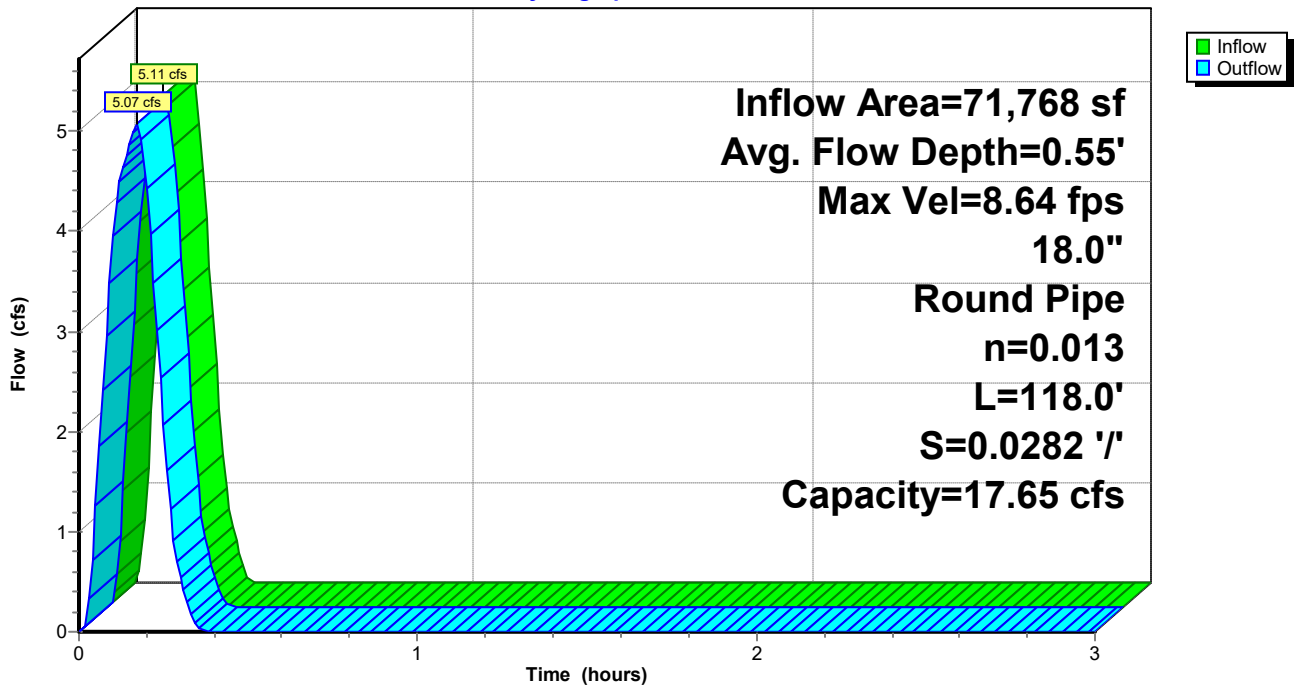

Summerwood Gym 3 2-yr

Prepared by Phillip Lewis Engineering

HydroCAD® 10.20-2f s/n 12520 © 2022 HydroCAD Software Solutions LLC

AR - Little Rock 2-yr Duration=10 min, Inten=4.36 in/hr

Printed 1/11/2024

Reach P-A3: Pipe A3

Stage-Discharge

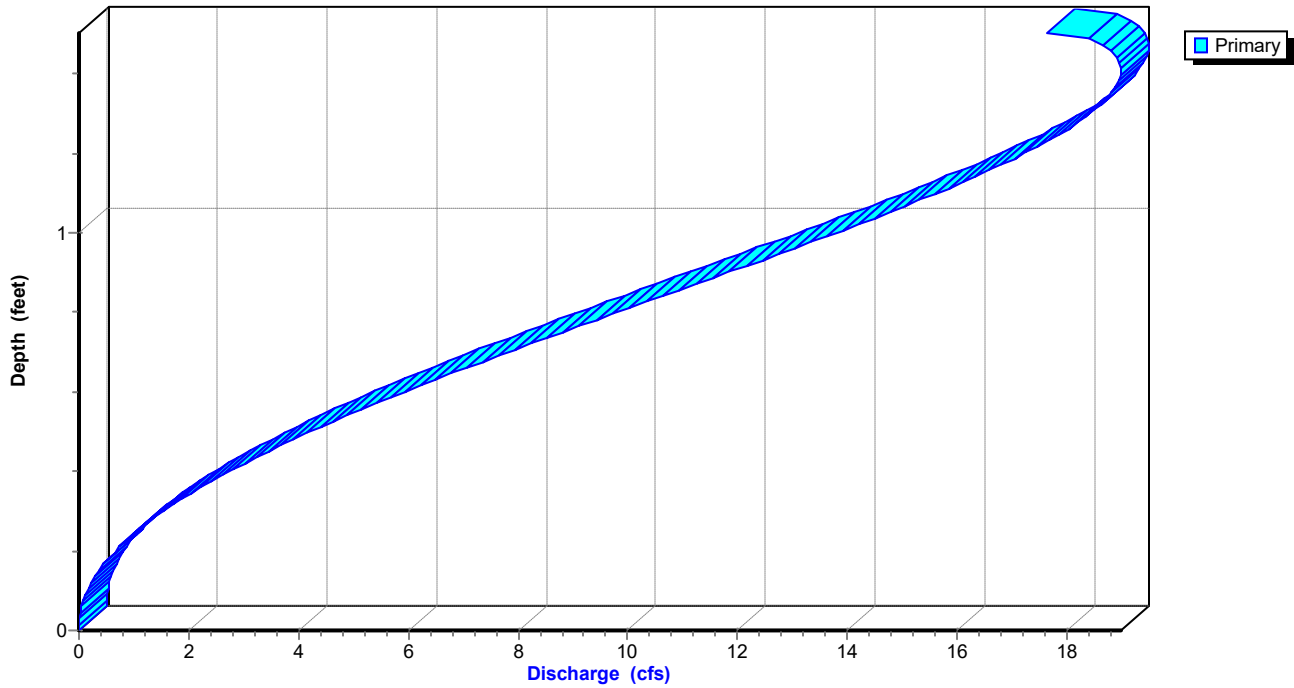

Summerwood Gym 3 2-yr*AR - Little Rock 2-yr Duration=10 min, Inten=4.36 in/hr*

Prepared by Phillip Lewis Engineering

Printed 1/11/2024

HydroCAD® 10.20-2f s/n 12520 © 2022 HydroCAD Software Solutions LLC

Stage-Area-Storage for Reach P-A3: Pipe A3

Elevation (feet)	End-Area (sq-ft)	Storage (cubic-feet)	Elevation (feet)	End-Area (sq-ft)	Storage (cubic-feet)
404.46	0.0	0	405.50	1.3	154
404.48	0.0	1	405.52	1.3	158
404.50	0.0	2	405.54	1.4	161
404.52	0.0	3	405.56	1.4	164
404.54	0.0	4	405.58	1.4	167
404.56	0.1	6	405.60	1.4	170
404.58	0.1	8	405.62	1.5	173
404.60	0.1	10	405.64	1.5	176
404.62	0.1	12	405.66	1.5	179
404.64	0.1	14	405.68	1.5	182
404.66	0.1	17	405.70	1.6	184
404.68	0.2	19	405.72	1.6	187
404.70	0.2	22	405.74	1.6	190
404.72	0.2	24	405.76	1.6	192
404.74	0.2	27	405.78	1.6	194
404.76	0.3	30	405.80	1.7	197
404.78	0.3	33	405.82	1.7	199
404.80	0.3	35	405.84	1.7	201
404.82	0.3	38	405.86	1.7	203
404.84	0.4	42	405.88	1.7	204
404.86	0.4	45	405.90	1.7	206
404.88	0.4	48	405.92	1.8	207
404.90	0.4	51	405.94	1.8	208
404.92	0.5	54	405.96	1.8	209
404.94	0.5	58			
404.96	0.5	61			
404.98	0.5	64			
405.00	0.6	68			
405.02	0.6	71			
405.04	0.6	74			
405.06	0.7	78			
405.08	0.7	81			
405.10	0.7	85			
405.12	0.7	88			
405.14	0.8	92			
405.16	0.8	95			
405.18	0.8	99			
405.20	0.9	102			
405.22	0.9	106			
405.24	0.9	110			
405.26	1.0	113			
405.28	1.0	117			
405.30	1.0	120			
405.32	1.0	124			
405.34	1.1	127			
405.36	1.1	131			
405.38	1.1	134			
405.40	1.2	138			
405.42	1.2	141			
405.44	1.2	144			
405.46	1.3	148			
405.48	1.3	151			

Summerwood Gym 3 2-yr

Prepared by Phillip Lewis Engineering

HydroCAD® 10.20-2f s/n 12520 © 2022 HydroCAD Software Solutions LLC

AR - Little Rock 2-yr Duration=10 min, Inten=4.36 in/hr

Printed 1/11/2024

Summary for Reach P-A4: Pipe A4

Inflow Area = 71,768 sf, 0.00% Impervious, Inflow Depth = 0.52" for 2-yr event
Inflow = 5.07 cfs @ 0.17 hrs, Volume= 3,082 cf
Outflow = 5.05 cfs @ 0.18 hrs, Volume= 3,082 cf, Atten= 0%, Lag= 0.4 min
Routed to Pond DP1 : Re-Established East Pond

Routing by Stor-Ind+Trans method, Time Span= 0.00-3.00 hrs, dt= 0.01 hrs
Max. Velocity= 8.62 fps, Min. Travel Time= 0.3 min
Avg. Velocity = 3.43 fps, Avg. Travel Time= 0.6 min

Peak Storage= 77 cf @ 0.17 hrs
Average Depth at Peak Storage= 0.55' , Surface Width= 1.45'
Bank-Full Depth= 1.50' Flow Area= 1.8 sf, Capacity= 17.66 cfs

18.0" Round Pipe
n= 0.013 Corrugated PE, smooth interior
Length= 132.0' Slope= 0.0283 '/'
Inlet Invert= 401.03', Outlet Invert= 397.30'

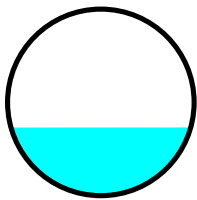

Reach P-A4: Pipe A4

Hydrograph

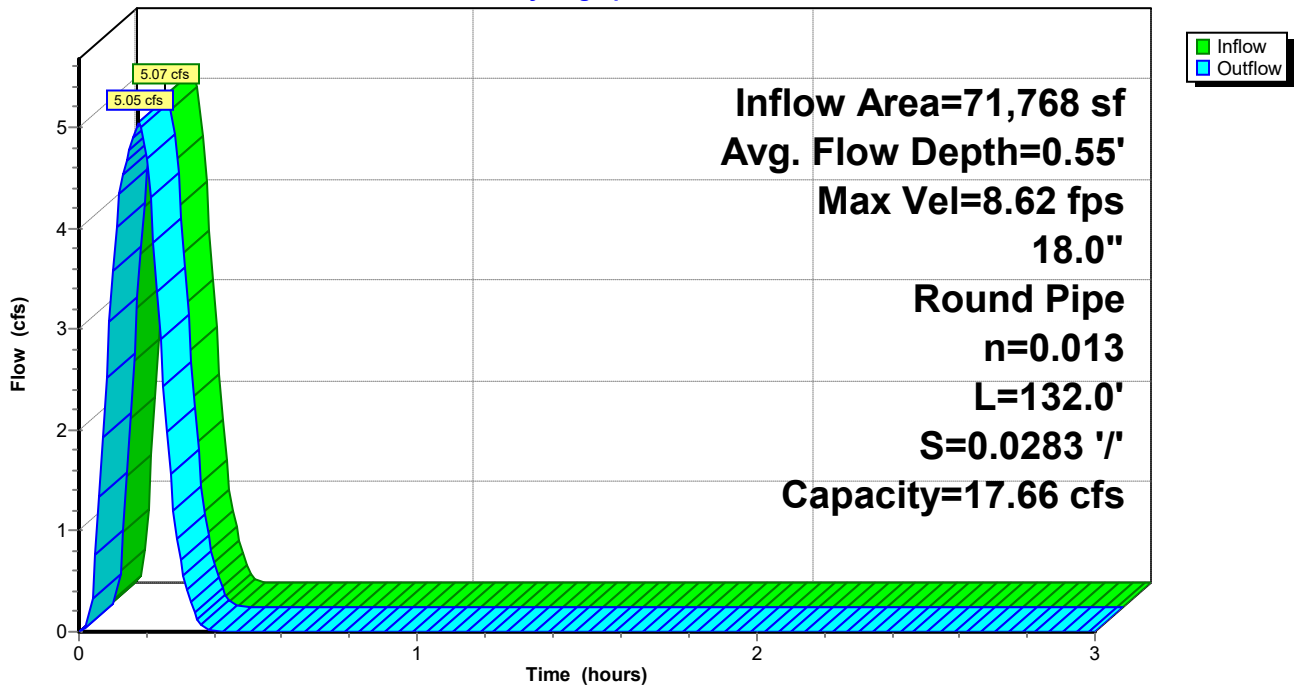

Reach P-A4: Pipe A4

Stage-Discharge

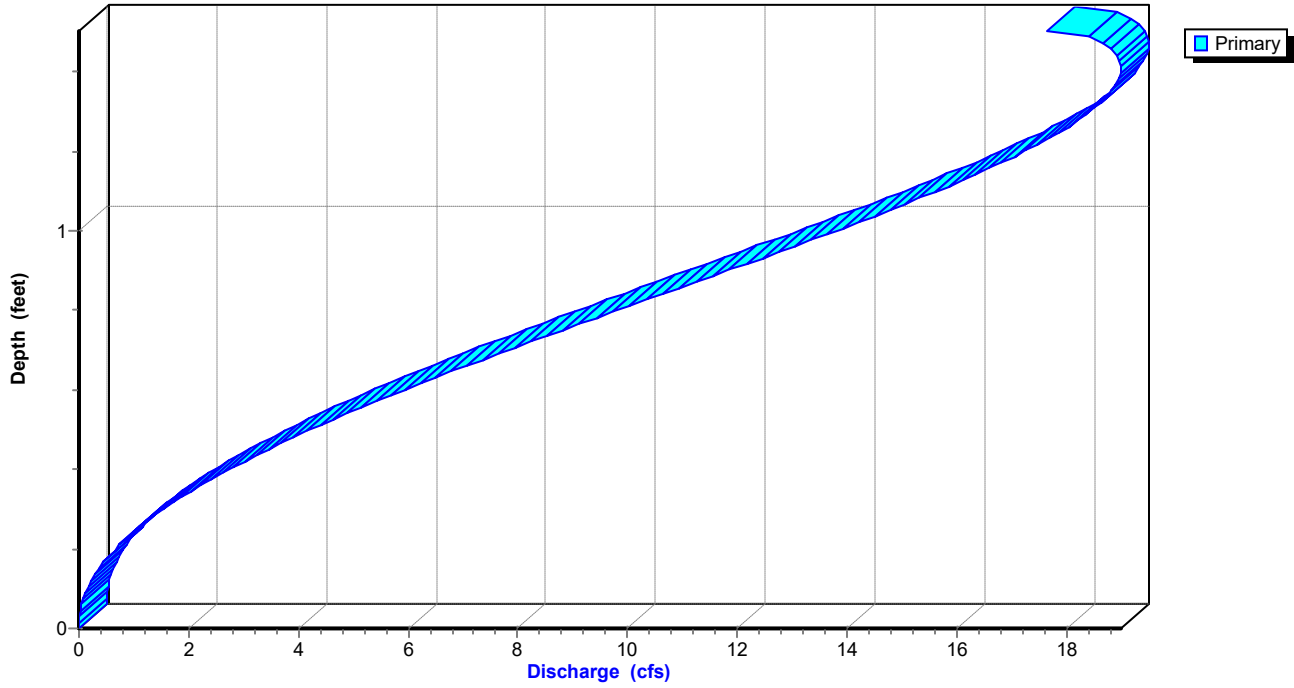

Summerwood Gym 3 2-yr*AR - Little Rock 2-yr Duration=10 min, Inten=4.36 in/hr*

Prepared by Phillip Lewis Engineering

Printed 1/11/2024

HydroCAD® 10.20-2f s/n 12520 © 2022 HydroCAD Software Solutions LLC

Stage-Area-Storage for Reach P-A4: Pipe A4

Elevation (feet)	End-Area (sq-ft)	Storage (cubic-feet)	Elevation (feet)	End-Area (sq-ft)	Storage (cubic-feet)
401.03	0.0	0	402.07	1.3	173
401.05	0.0	1	402.09	1.3	176
401.07	0.0	2	402.11	1.4	180
401.09	0.0	3	402.13	1.4	183
401.11	0.0	5	402.15	1.4	187
401.13	0.1	7	402.17	1.4	190
401.15	0.1	9	402.19	1.5	194
401.17	0.1	11	402.21	1.5	197
401.19	0.1	13	402.23	1.5	200
401.21	0.1	16	402.25	1.5	203
401.23	0.1	18	402.27	1.6	206
401.25	0.2	21	402.29	1.6	209
401.27	0.2	24	402.31	1.6	212
401.29	0.2	27	402.33	1.6	215
401.31	0.2	30	402.35	1.6	217
401.33	0.3	33	402.37	1.7	220
401.35	0.3	36	402.39	1.7	222
401.37	0.3	40	402.41	1.7	225
401.39	0.3	43	402.43	1.7	227
401.41	0.4	46	402.45	1.7	228
401.43	0.4	50	402.47	1.7	230
401.45	0.4	53	402.49	1.8	232
401.47	0.4	57	402.51	1.8	233
401.49	0.5	61	402.53	1.8	233
401.51	0.5	64			
401.53	0.5	68			
401.55	0.5	72			
401.57	0.6	76			
401.59	0.6	79			
401.61	0.6	83			
401.63	0.7	87			
401.65	0.7	91			
401.67	0.7	95			
401.69	0.7	99			
401.71	0.8	103			
401.73	0.8	107			
401.75	0.8	111			
401.77	0.9	115			
401.79	0.9	119			
401.81	0.9	123			
401.83	1.0	127			
401.85	1.0	130			
401.87	1.0	134			
401.89	1.0	138			
401.91	1.1	142			
401.93	1.1	146			
401.95	1.1	150			
401.97	1.2	154			
401.99	1.2	158			
402.01	1.2	161			
402.03	1.3	165			
402.05	1.3	169			

Summerwood Gym 3 2-yr

AR - Little Rock 2-yr Duration=10 min, Inten=4.36 in/hr

Prepared by Phillip Lewis Engineering

Printed 1/11/2024

HydroCAD® 10.20-2f s/n 12520 © 2022 HydroCAD Software Solutions LLC

Summary for Pond DP1: Re-Established East Pond

Inflow Area = 132,514 sf, 0.00% Impervious, Inflow Depth = 0.53" for 2-yr event
 Inflow = 9.45 cfs @ 0.16 hrs, Volume= 5,804 cf
 Outflow = 5.39 cfs @ 0.22 hrs, Volume= 5,804 cf, Atten= 43%, Lag= 3.6 min
 Primary = 5.39 cfs @ 0.22 hrs, Volume= 5,804 cf
 Routed to Link Post-Dev : APPROX DISCHARGE

Routing by Stor-Ind method, Time Span= 0.00-3.00 hrs, dt= 0.01 hrs
 Peak Elev= 397.63' @ 0.22 hrs Storage= 2,855 cf

Plug-Flow detention time= 7.8 min calculated for 5,804 cf (100% of inflow)
 Center-of-Mass det. time= 7.7 min (16.7 - 9.0)

Volume	Invert	Avail.Storage	Storage Description
#1	396.00'	8,557 cf	Custom Stage Data Listed below

Elevation (feet)	Inc.Store (cubic-feet)	Cum.Store (cubic-feet)
396.00	0	0
396.50	250	250
397.00	1,092	1,342
398.00	2,387	3,729
399.00	2,405	6,134
400.00	2,423	8,557

Device	Routing	Invert	Outlet Devices
#1	Primary	399.00'	5.0' long Sharp-Crested Rectangular Weir 2 End Contraction(s)
#2	Primary	396.00'	1.1' long Sharp-Crested Rectangular Weir 2 End Contraction(s) 10.0' Crest Height

Primary OutFlow Max=5.38 cfs @ 0.22 hrs HW=397.63' (Free Discharge)

↑ **1=Sharp-Crested Rectangular Weir** (Controls 0.00 cfs)
 ↓ **2=Sharp-Crested Rectangular Weir** (Weir Controls 5.38 cfs @ 4.26 fps)

Pond DP1: Re-Established East Pond

Hydrograph

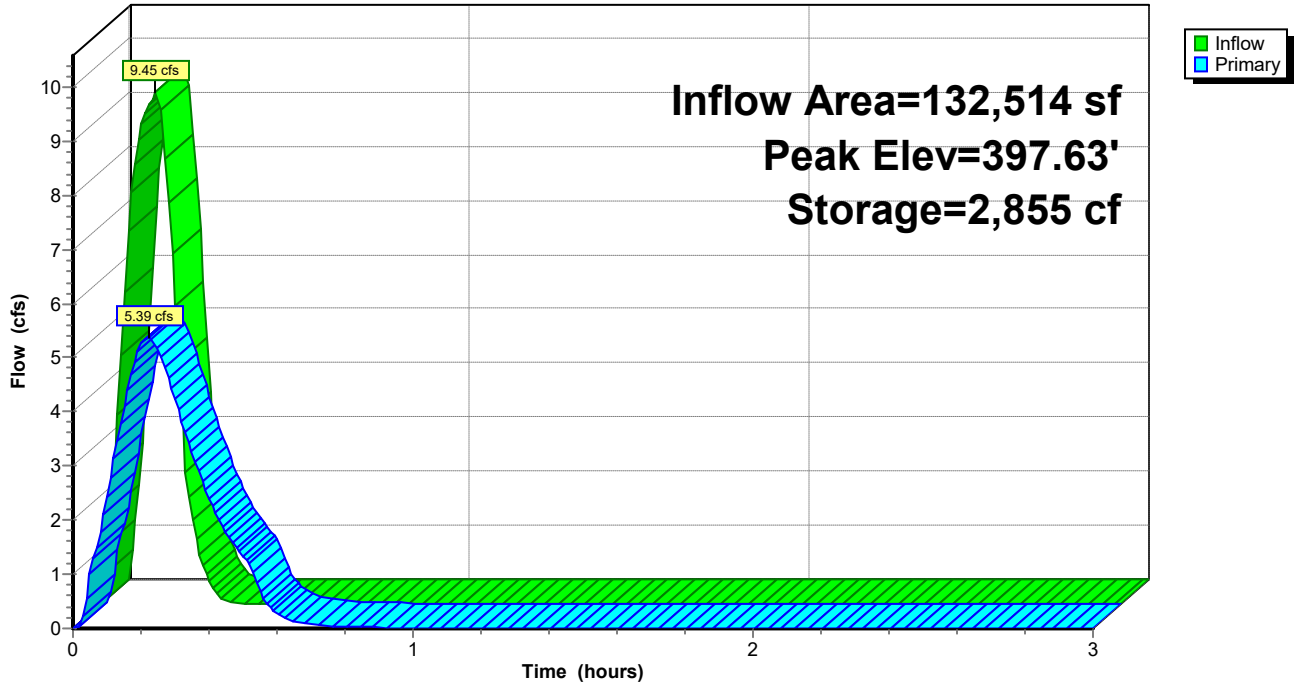

Pond DP1: Re-Established East Pond

Stage-Discharge

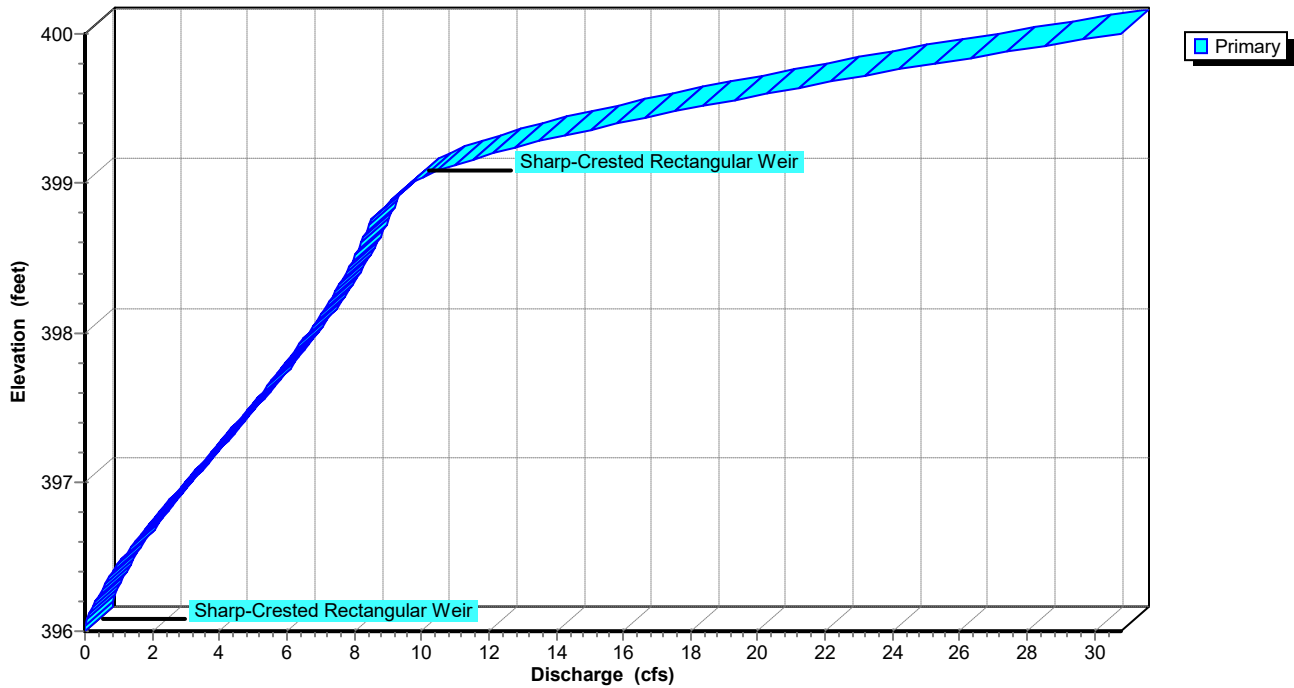

Summerwood Gym 3 2-yr*AR - Little Rock 2-yr Duration=10 min, Inten=4.36 in/hr*

Prepared by Phillip Lewis Engineering

Printed 1/11/2024

HydroCAD® 10.20-2f s/n 12520 © 2022 HydroCAD Software Solutions LLC

Stage-Area-Storage for Pond DP1: Re-Established East Pond

Elevation (feet)	Storage (cubic-feet)	Elevation (feet)	Storage (cubic-feet)
396.00	0	398.60	5,172
396.05	25	398.65	5,292
396.10	50	398.70	5,412
396.15	75	398.75	5,533
396.20	100	398.80	5,653
396.25	125	398.85	5,773
396.30	150	398.90	5,893
396.35	175	398.95	6,014
396.40	200	399.00	6,134
396.45	225	399.05	6,255
396.50	250	399.10	6,376
396.55	359	399.15	6,497
396.60	468	399.20	6,619
396.65	578	399.25	6,740
396.70	687	399.30	6,861
396.75	796	399.35	6,982
396.80	905	399.40	7,103
396.85	1,014	399.45	7,224
396.90	1,124	399.50	7,346
396.95	1,233	399.55	7,467
397.00	1,342	399.60	7,588
397.05	1,461	399.65	7,709
397.10	1,581	399.70	7,830
397.15	1,700	399.75	7,951
397.20	1,819	399.80	8,072
397.25	1,939	399.85	8,194
397.30	2,058	399.90	8,315
397.35	2,177	399.95	8,436
397.40	2,297	400.00	8,557
397.45	2,416		
397.50	2,536		
397.55	2,655		
397.60	2,774		
397.65	2,894		
397.70	3,013		
397.75	3,132		
397.80	3,252		
397.85	3,371		
397.90	3,490		
397.95	3,610		
398.00	3,729		
398.05	3,849		
398.10	3,970		
398.15	4,090		
398.20	4,210		
398.25	4,330		
398.30	4,451		
398.35	4,571		
398.40	4,691		
398.45	4,811		
398.50	4,932		
398.55	5,052		

Summerwood Gym 3 2-yr

AR - Little Rock 2-yr Duration=10 min, Inten=4.36 in/hr

Prepared by Phillip Lewis Engineering

Printed 1/11/2024

HydroCAD® 10.20-2f s/n 12520 © 2022 HydroCAD Software Solutions LLC

Summary for Link Post-Dev: APPROX DISCHARGE

Inflow Area = 206,166 sf, 0.00% Impervious, Inflow Depth = 0.53" for 2-yr event
Inflow = 10.14 cfs @ 0.17 hrs, Volume= 9,191 cf
Primary = 10.14 cfs @ 0.17 hrs, Volume= 9,191 cf, Atten= 0%, Lag= 0.0 min

Primary outflow = Inflow, Time Span= 0.00-3.00 hrs, dt= 0.01 hrs

Link Post-Dev: APPROX DISCHARGE

Hydrograph

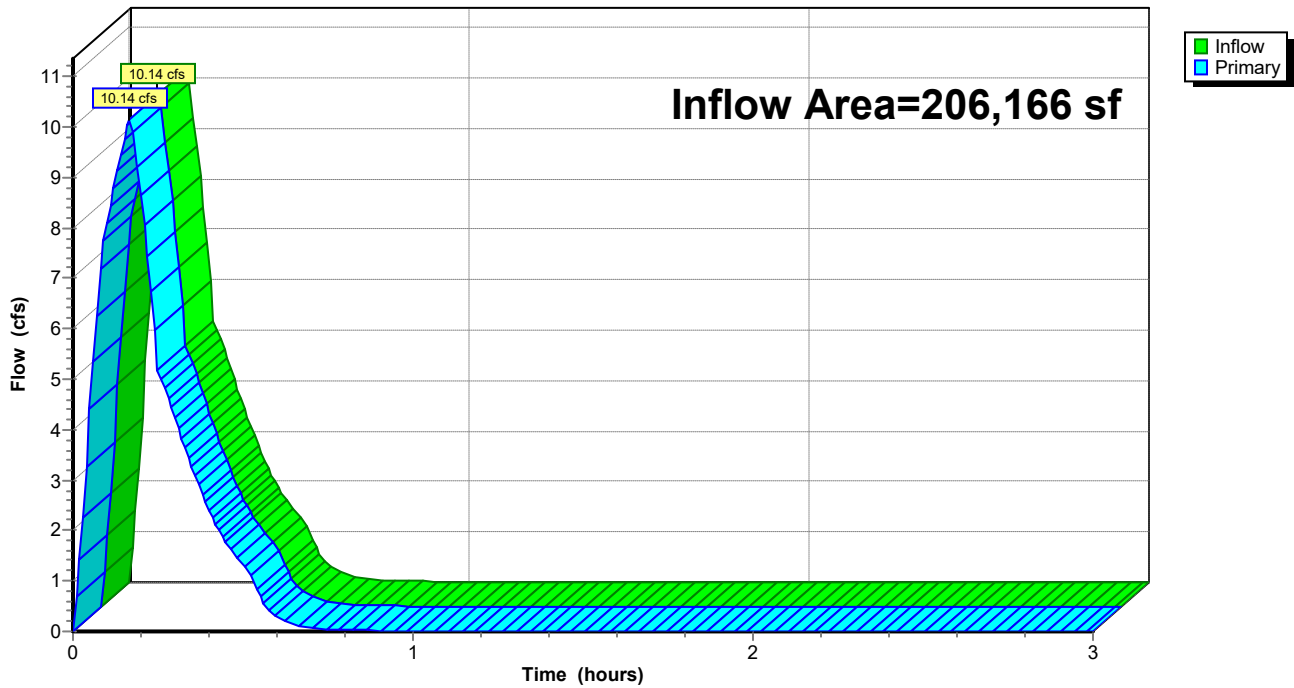

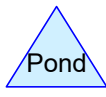
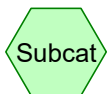
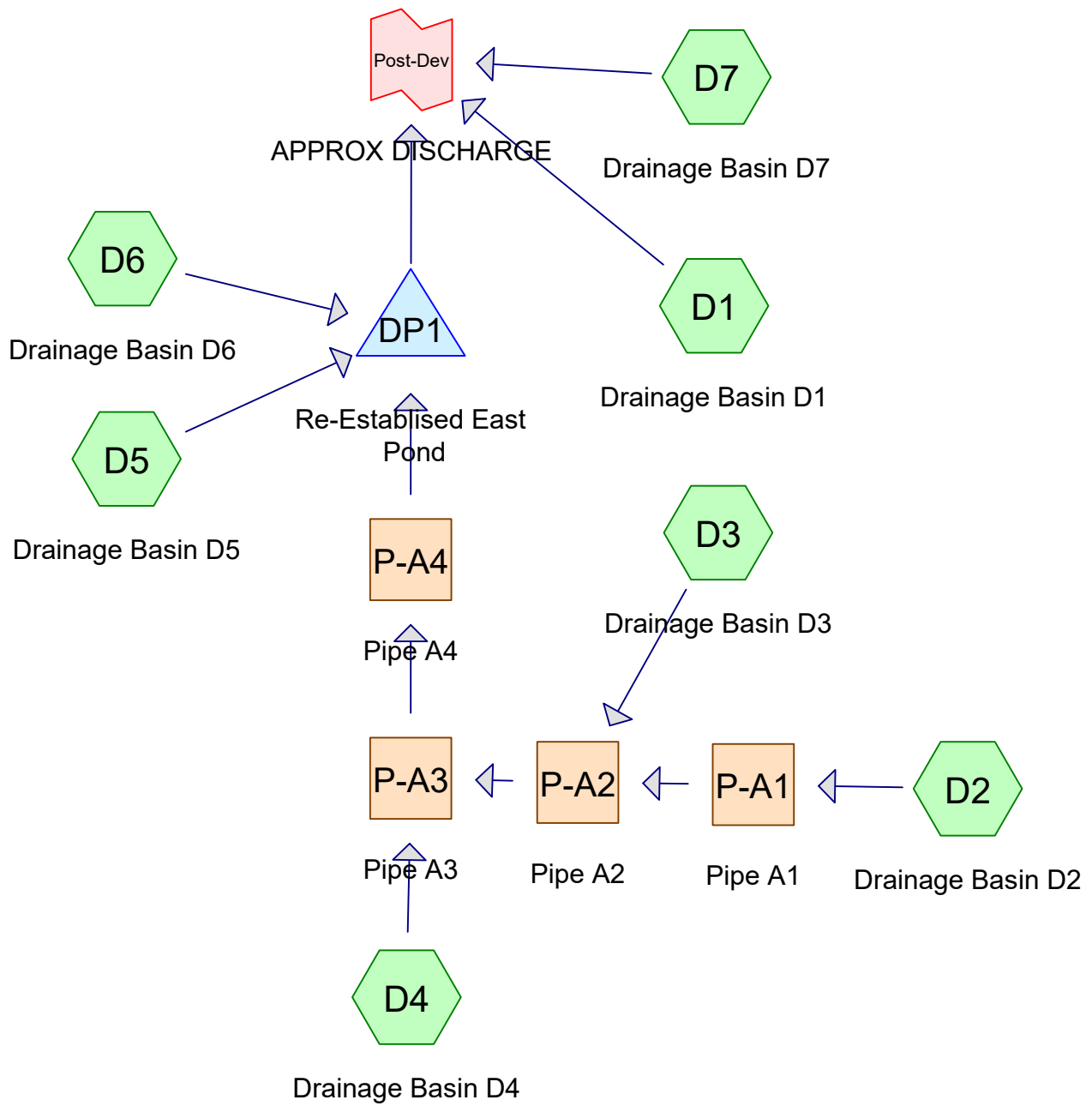

Routing Diagram for Summerwood Gym 3
 Prepared by Phillip Lewis Engineering, Printed 1/11/2024
 HydroCAD® 10.20-2f s/n 12520 © 2022 HydroCAD Software Solutions LLC

Summerwood Gym 3

Prepared by Phillip Lewis Engineering

HydroCAD® 10.20-2f s/n 12520 © 2022 HydroCAD Software Solutions LLC

AR - Little Rock 5-yr Duration=10 min, Inten=5.17 in/hr

Printed 1/11/2024

Summary for Subcatchment D1: Drainage Basin D1

Runoff = 5.30 cfs @ 0.09 hrs, Volume= 3,176 cf, Depth= 0.78"
 Routed to Link Post-Dev : APPROX DISCHARGE

Runoff by Rational method, Rise/Fall=1.0/1.0 xTc, Time Span= 0.00-3.00 hrs, dt= 0.01 hrs
 AR - Little Rock 5-yr Duration=10 min, Inten=5.17 in/hr

Area (sf)	C	Description
3,421	0.40	Sod Yard
45,236	0.95	Road, Drives, Sidewalks
48,657	0.91	Weighted Average
3,421		7.03% Pervious Area
45,236		92.97% Impervious Area

Tc (min)	Length (feet)	Slope (ft/ft)	Velocity (ft/sec)	Capacity (cfs)	Description
5.0					Direct Entry, Overland Concentrated Flow (Min)

Subcatchment D1: Drainage Basin D1

Hydrograph

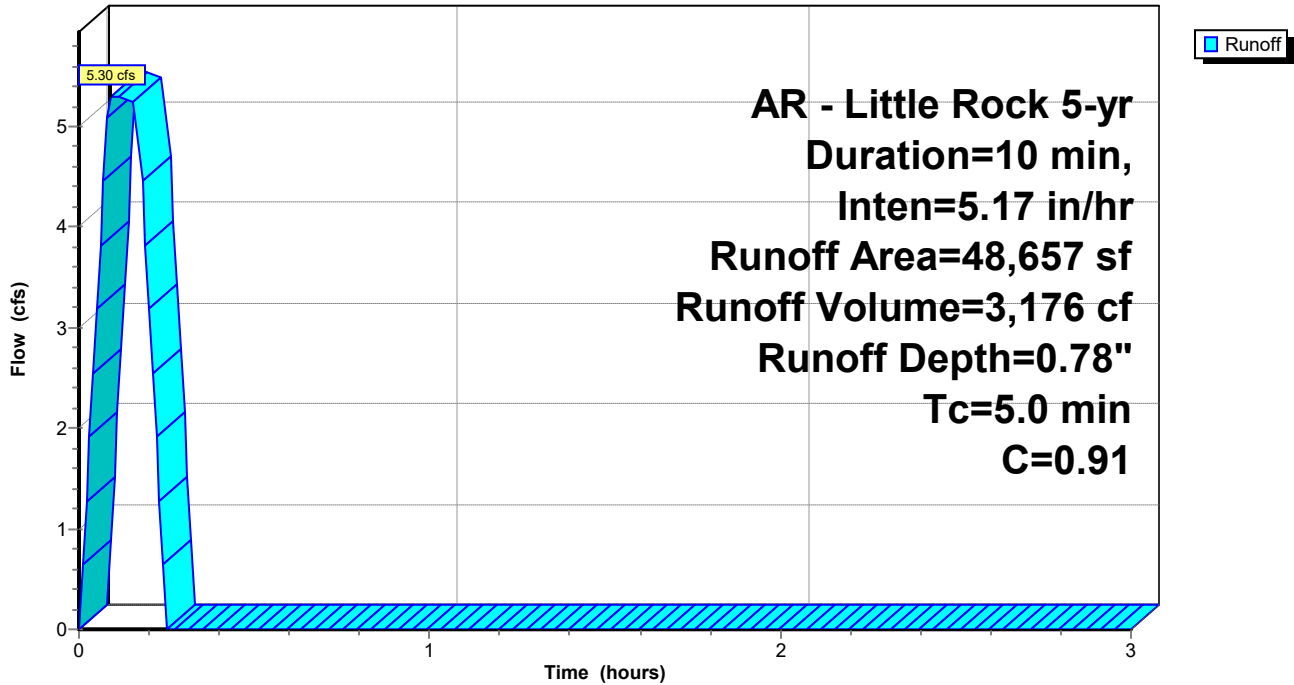

Summerwood Gym 3

Prepared by Phillip Lewis Engineering

HydroCAD® 10.20-2f s/n 12520 © 2022 HydroCAD Software Solutions LLC

AR - Little Rock 5-yr Duration=10 min, Inten=5.17 in/hr

Printed 1/11/2024

Summary for Subcatchment D2: Drainage Basin D2

Runoff = 2.25 cfs @ 0.09 hrs, Volume= 1,348 cf, Depth= 0.66"

Routed to Reach P-A1 : Pipe A1

Runoff by Rational method, Rise/Fall=1.0/1.0 xTc, Time Span= 0.00-3.00 hrs, dt= 0.01 hrs

AR - Little Rock 5-yr Duration=10 min, Inten=5.17 in/hr

Area (sf)	C	Description
8,845	0.45	Rip Rap Embankment
15,566	0.95	Roof, Drives, Sidewalks
24,411	0.77	Weighted Average
8,845		36.23% Pervious Area
15,566		63.77% Impervious Area

Tc (min)	Length (feet)	Slope (ft/ft)	Velocity (ft/sec)	Capacity (cfs)	Description
5.0	415		1.38		Direct Entry, Overland Concentrated Flow (Min)

Subcatchment D2: Drainage Basin D2

Hydrograph

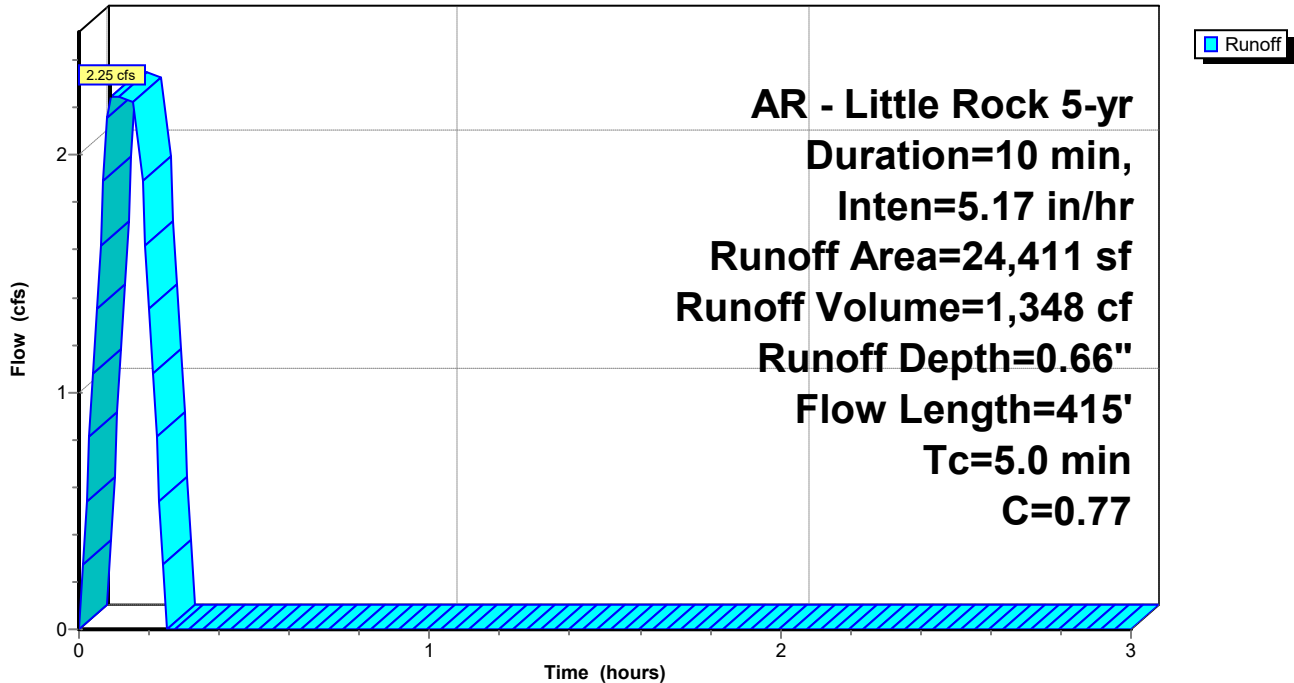

Summerwood Gym 3

Prepared by Phillip Lewis Engineering

HydroCAD® 10.20-2f s/n 12520 © 2022 HydroCAD Software Solutions LLC

AR - Little Rock 5-yr Duration=10 min, Inten=5.17 in/hr

Printed 1/11/2024

Summary for Subcatchment D3: Drainage Basin D3

Runoff = 1.67 cfs @ 0.09 hrs, Volume= 998 cf, Depth= 0.78"

Routed to Reach P-A2 : Pipe A2

Runoff by Rational method, Rise/Fall=1.0/1.0 xTc, Time Span= 0.00-3.00 hrs, dt= 0.01 hrs

AR - Little Rock 5-yr Duration=10 min, Inten=5.17 in/hr

Area (sf)	C	Description
1,065	0.40	Sod Yard
14,229	0.95	Paving, Sidewalks
15,294	0.91	Weighted Average
1,065		6.96% Pervious Area
14,229		93.04% Impervious Area

Tc (min)	Length (feet)	Slope (ft/ft)	Velocity (ft/sec)	Capacity (cfs)	Description
5.0	415		1.38		Direct Entry, Overland Concentrated Flow (Min)

Subcatchment D3: Drainage Basin D3

Hydrograph

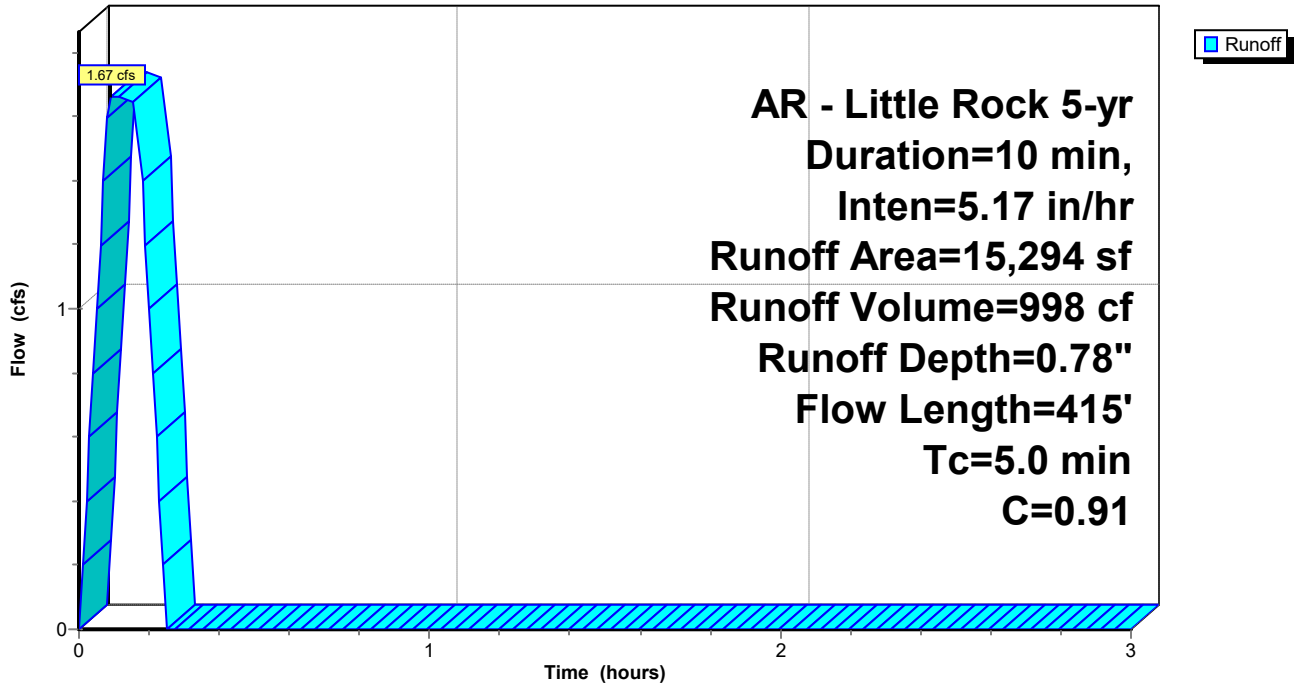

Summerwood Gym 3

Prepared by Phillip Lewis Engineering

HydroCAD® 10.20-2f s/n 12520 © 2022 HydroCAD Software Solutions LLC

AR - Little Rock 5-yr Duration=10 min, Inten=5.17 in/hr

Printed 1/11/2024

Summary for Subcatchment D4: Drainage Basin D4

Runoff = 2.30 cfs @ 0.17 hrs, Volume= 1,404 cf, Depth= 0.53"

Routed to Reach P-A3 : Pipe A3

Runoff by Rational method, Rise/Fall=1.0/1.0 xTc, Time Span= 0.00-3.00 hrs, dt= 0.01 hrs

AR - Little Rock 5-yr Duration=10 min, Inten=5.17 in/hr

Area (sf)	C	Description
20,032	0.40	
12,031	0.95	
32,063	0.61	Weighted Average
20,032		62.48% Pervious Area
12,031		37.52% Impervious Area

Tc (min)	Length (feet)	Slope (ft/ft)	Velocity (ft/sec)	Capacity (cfs)	Description
10.0	415		0.69		Direct Entry, Overland Concentrated Flow (Min)

Subcatchment D4: Drainage Basin D4

Hydrograph

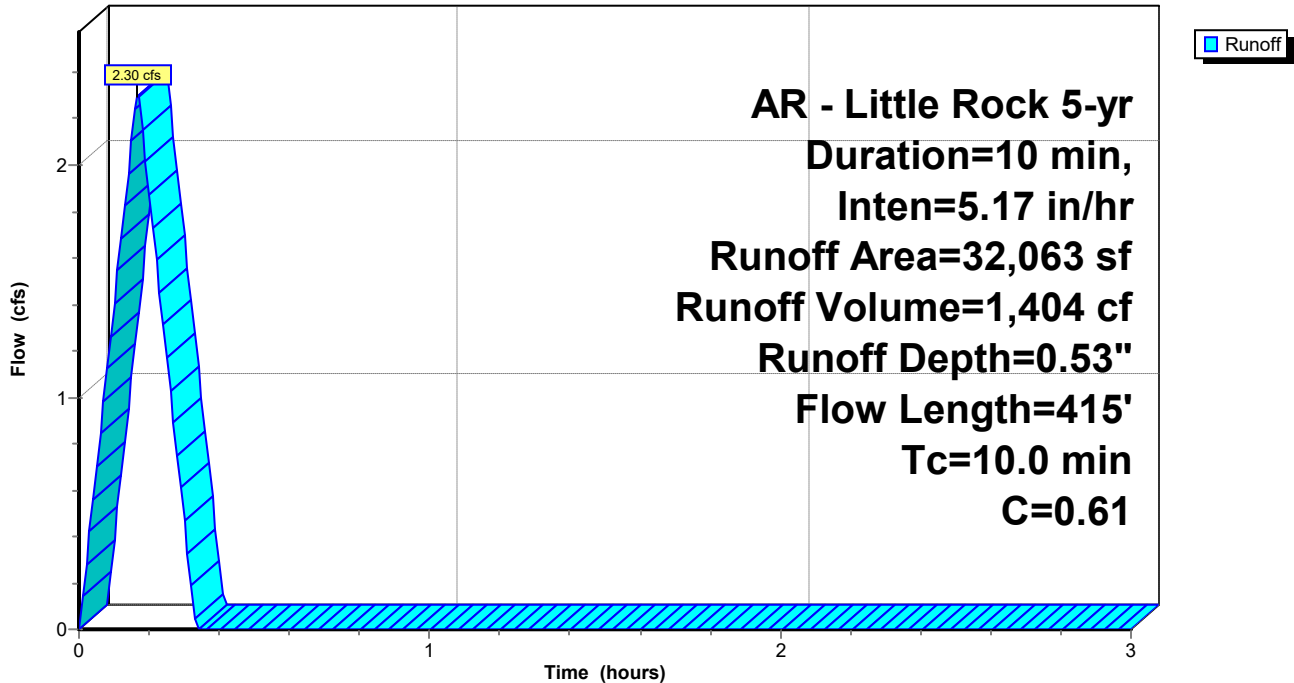

Summerwood Gym 3

Prepared by Phillip Lewis Engineering

HydroCAD® 10.20-2f s/n 12520 © 2022 HydroCAD Software Solutions LLC

AR - Little Rock 5-yr Duration=10 min, Inten=5.17 in/hr

Printed 1/11/2024

Summary for Subcatchment D5: Drainage Basin D5

Runoff = 3.34 cfs @ 0.09 hrs, Volume= 2,001 cf, Depth= 0.58"
 Routed to Pond DP1 : Re-Established East Pond

Runoff by Rational method, Rise/Fall=1.0/1.0 xTc, Time Span= 0.00-3.00 hrs, dt= 0.01 hrs
 AR - Little Rock 5-yr Duration=10 min, Inten=5.17 in/hr

Area (sf)	C	Description
21,201	0.40	Sod Yard, Natural Vegetation
20,437	0.95	Paving, Sidewalks
41,638	0.67	Weighted Average
21,201		50.92% Pervious Area
20,437		49.08% Impervious Area

Tc (min)	Length (feet)	Slope (ft/ft)	Velocity (ft/sec)	Capacity (cfs)	Description
5.0					Direct Entry, Overland Concentrated Flow (Min)

Subcatchment D5: Drainage Basin D5

Hydrograph

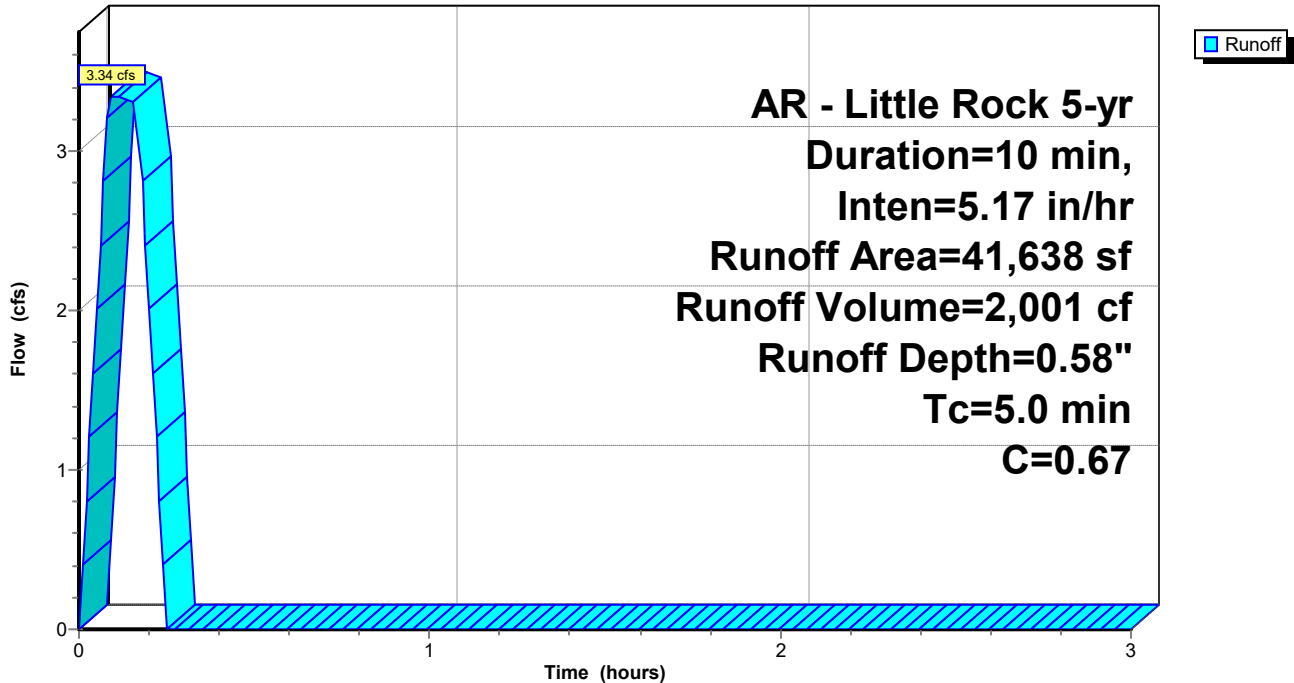

Summerwood Gym 3

Prepared by Phillip Lewis Engineering

HydroCAD® 10.20-2f s/n 12520 © 2022 HydroCAD Software Solutions LLC

AR - Little Rock 5-yr Duration=10 min, Inten=5.17 in/hr

Printed 1/11/2024

Summary for Subcatchment D6: Drainage Basin D6

Runoff = 2.17 cfs @ 0.09 hrs, Volume= 1,302 cf, Depth= 0.82"
Routed to Pond DP1 : Re-Established East Pond

Runoff by Rational method, Rise/Fall=1.0/1.0 xTc, Time Span= 0.00-3.00 hrs, dt= 0.01 hrs
AR - Little Rock 5-yr Duration=10 min, Inten=5.17 in/hr

Area (sf)	C	Description
19,108	0.95	Roof
19,108		100.00% Impervious Area

Tc (min)	Length (feet)	Slope (ft/ft)	Velocity (ft/sec)	Capacity (cfs)	Description
5.0					Direct Entry, Overland Concentrated Flow (Min)

Subcatchment D6: Drainage Basin D6

Hydrograph

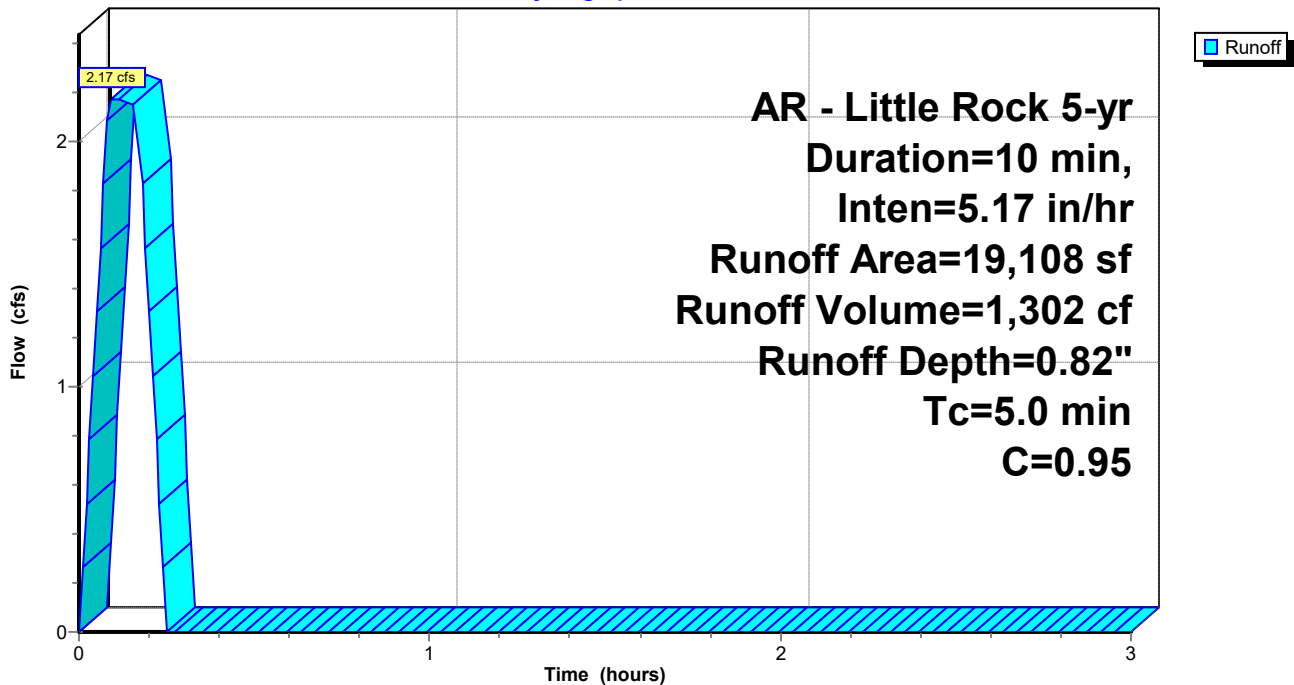

Summerwood Gym 3

Prepared by Phillip Lewis Engineering

HydroCAD® 10.20-2f s/n 12520 © 2022 HydroCAD Software Solutions LLC

AR - Little Rock 5-yr Duration=10 min, Inten=5.17 in/hr

Printed 1/11/2024

Summary for Subcatchment D7: Drainage Basin D7

Runoff = 1.62 cfs @ 0.09 hrs, Volume= 968 cf, Depth= 0.46"
 Routed to Link Post-Dev : APPROX DISCHARGE

Runoff by Rational method, Rise/Fall=1.0/1.0 xTc, Time Span= 0.00-3.00 hrs, dt= 0.01 hrs
 AR - Little Rock 5-yr Duration=10 min, Inten=5.17 in/hr

Area (sf)	C	Description
18,798	0.40	Sod Yard, Natural Vegetation
6,197	0.95	Paving, Sidewalks
24,995	0.54	Weighted Average
18,798		75.21% Pervious Area
6,197		24.79% Impervious Area

Tc (min)	Length (feet)	Slope (ft/ft)	Velocity (ft/sec)	Capacity (cfs)	Description
5.0					Direct Entry, Overland Concentrated Flow (Min)

Subcatchment D7: Drainage Basin D7

Hydrograph

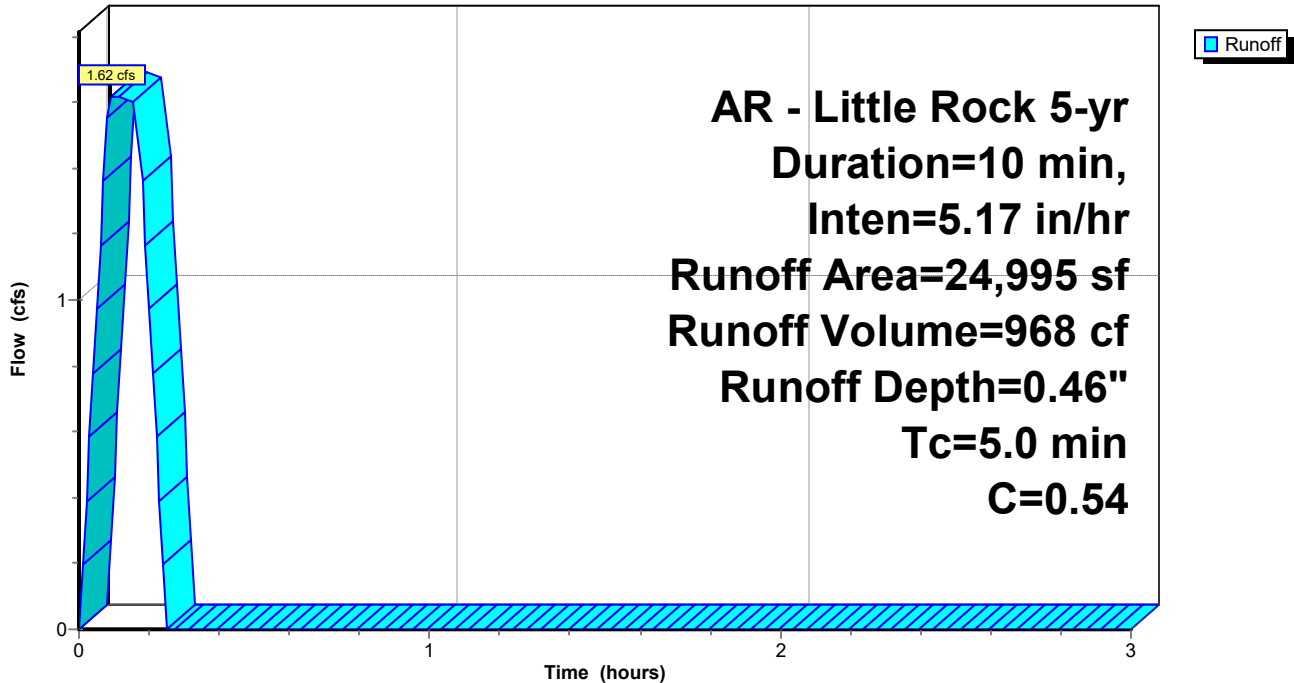

Summerwood Gym 3

AR - Little Rock 5-yr Duration=10 min, Inten=5.17 in/hr

Prepared by Phillip Lewis Engineering

Printed 1/11/2024

HydroCAD® 10.20-2f s/n 12520 © 2022 HydroCAD Software Solutions LLC

Summary for Reach P-A1: Pipe A1

Inflow Area = 24,411 sf, 63.77% Impervious, Inflow Depth = 0.66" for 5-yr event
Inflow = 2.25 cfs @ 0.09 hrs, Volume= 1,348 cf
Outflow = 2.25 cfs @ 0.11 hrs, Volume= 1,348 cf, Atten= 0%, Lag= 1.2 min
Routed to Reach P-A2 : Pipe A2

Routing by Stor-Ind+Trans method, Time Span= 0.00-3.00 hrs, dt= 0.01 hrs
Max. Velocity= 6.75 fps, Min. Travel Time= 0.1 min
Avg. Velocity = 4.79 fps, Avg. Travel Time= 0.2 min

Peak Storage= 17 cf @ 0.09 hrs
Average Depth at Peak Storage= 0.37' , Surface Width= 1.29'
Bank-Full Depth= 1.50' Flow Area= 1.8 sf, Capacity= 17.28 cfs

18.0" Round Pipe
n= 0.013 Corrugated PE, smooth interior
Length= 51.0' Slope= 0.0271 '/'
Inlet Invert= 408.33', Outlet Invert= 406.95'

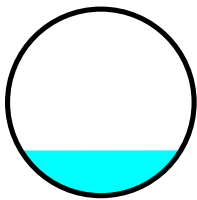

Reach P-A1: Pipe A1

Hydrograph

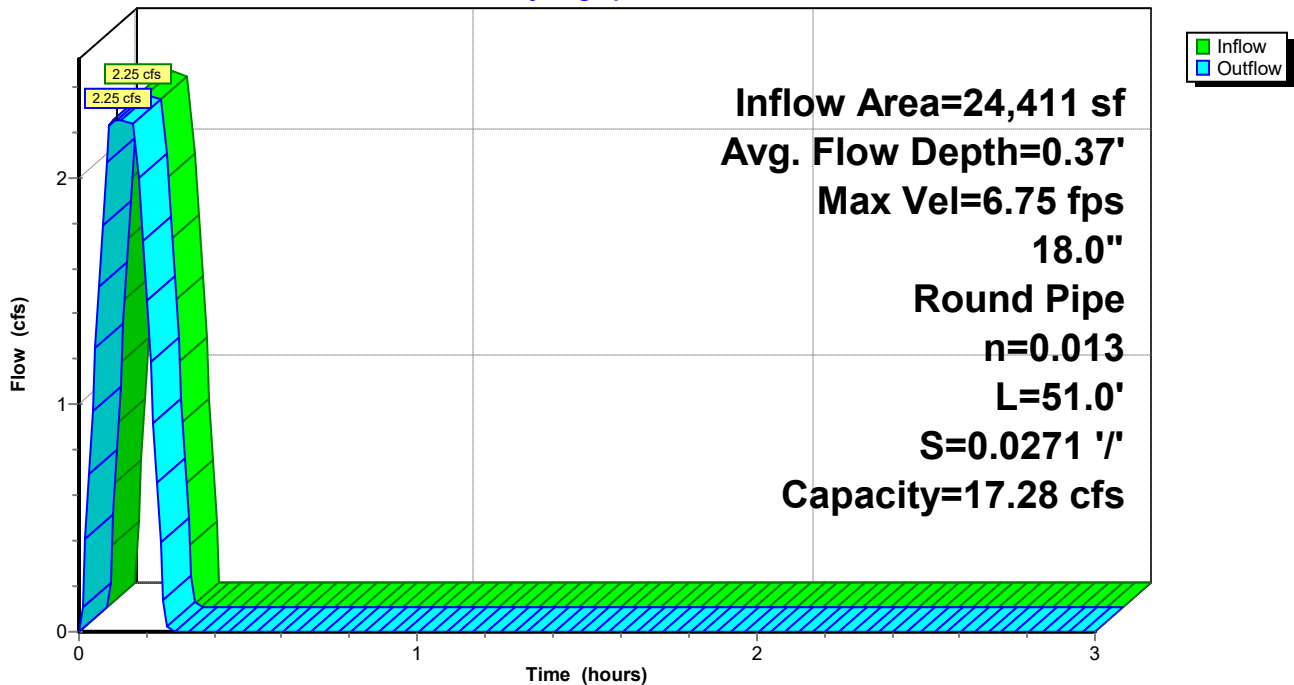

Summerwood Gym 3

Prepared by Phillip Lewis Engineering

HydroCAD® 10.20-2f s/n 12520 © 2022 HydroCAD Software Solutions LLC

AR - Little Rock 5-yr Duration=10 min, Inten=5.17 in/hr

Printed 1/11/2024

Reach P-A1: Pipe A1

Stage-Discharge

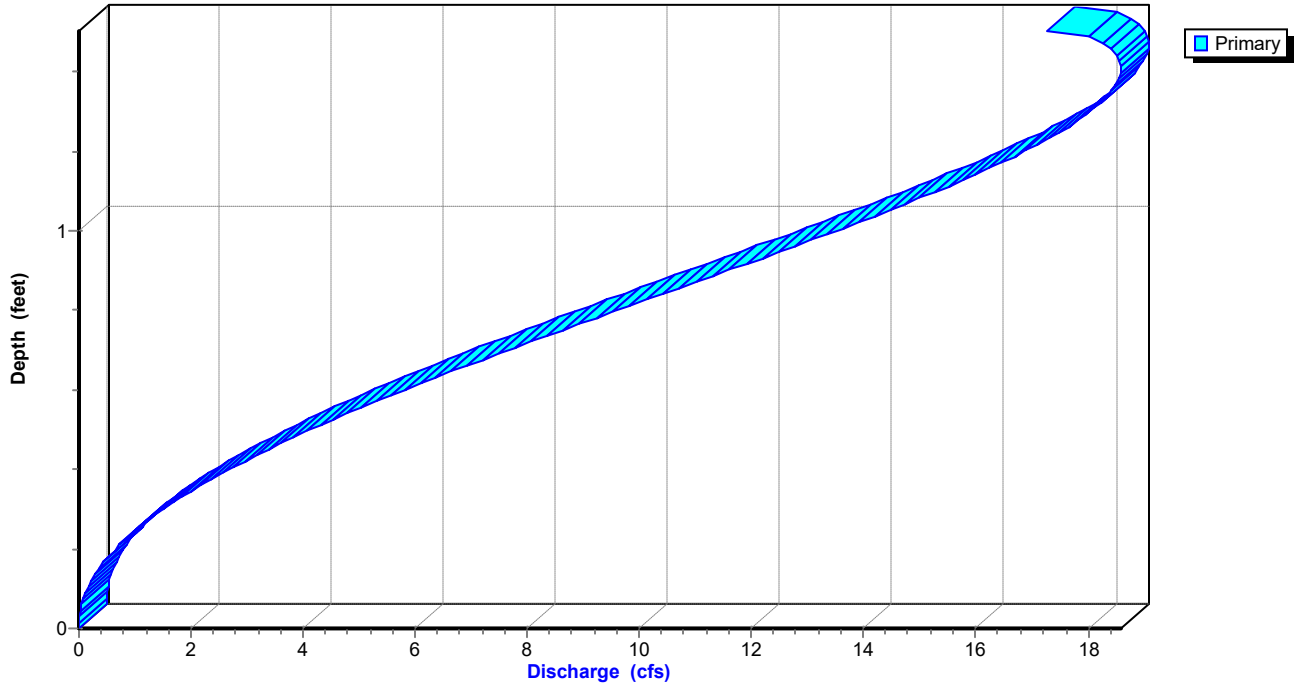

Summerwood Gym 3*AR - Little Rock 5-yr Duration=10 min, Inten=5.17 in/hr*

Prepared by Phillip Lewis Engineering

Printed 1/11/2024

HydroCAD® 10.20-2f s/n 12520 © 2022 HydroCAD Software Solutions LLC

Stage-Area-Storage for Reach P-A1: Pipe A1

Elevation (feet)	End-Area (sq-ft)	Storage (cubic-feet)	Elevation (feet)	End-Area (sq-ft)	Storage (cubic-feet)
408.33	0.0	0	409.37	1.3	67
408.35	0.0	0	409.39	1.3	68
408.37	0.0	1	409.41	1.4	69
408.39	0.0	1	409.43	1.4	71
408.41	0.0	2	409.45	1.4	72
408.43	0.1	3	409.47	1.4	73
408.45	0.1	3	409.49	1.5	75
408.47	0.1	4	409.51	1.5	76
408.49	0.1	5	409.53	1.5	77
408.51	0.1	6	409.55	1.5	78
408.53	0.1	7	409.57	1.6	80
408.55	0.2	8	409.59	1.6	81
408.57	0.2	9	409.61	1.6	82
408.59	0.2	10	409.63	1.6	83
408.61	0.2	12	409.65	1.6	84
408.63	0.3	13	409.67	1.7	85
408.65	0.3	14	409.69	1.7	86
408.67	0.3	15	409.71	1.7	87
408.69	0.3	17	409.73	1.7	88
408.71	0.4	18	409.75	1.7	88
408.73	0.4	19	409.77	1.7	89
408.75	0.4	21	409.79	1.8	89
408.77	0.4	22	409.81	1.8	90
408.79	0.5	23	409.83	1.8	90
408.81	0.5	25			
408.83	0.5	26			
408.85	0.5	28			
408.87	0.6	29			
408.89	0.6	31			
408.91	0.6	32			
408.93	0.7	34			
408.95	0.7	35			
408.97	0.7	37			
408.99	0.7	38			
409.01	0.8	40			
409.03	0.8	41			
409.05	0.8	43			
409.07	0.9	44			
409.09	0.9	46			
409.11	0.9	47			
409.13	1.0	49			
409.15	1.0	50			
409.17	1.0	52			
409.19	1.0	53			
409.21	1.1	55			
409.23	1.1	56			
409.25	1.1	58			
409.27	1.2	59			
409.29	1.2	61			
409.31	1.2	62			
409.33	1.3	64			
409.35	1.3	65			

Summerwood Gym 3

AR - Little Rock 5-yr Duration=10 min, Inten=5.17 in/hr

Prepared by Phillip Lewis Engineering

Printed 1/11/2024

HydroCAD® 10.20-2f s/n 12520 © 2022 HydroCAD Software Solutions LLC

Summary for Reach P-A2: Pipe A2

Inflow Area = 39,705 sf, 75.04% Impervious, Inflow Depth = 0.71" for 5-yr event
Inflow = 3.92 cfs @ 0.11 hrs, Volume= 2,346 cf
Outflow = 3.92 cfs @ 0.15 hrs, Volume= 2,346 cf, Atten= 0%, Lag= 2.4 min
Routed to Reach P-A3 : Pipe A3

Routing by Stor-Ind+Trans method, Time Span= 0.00-3.00 hrs, dt= 0.01 hrs
Max. Velocity= 6.05 fps, Min. Travel Time= 0.5 min
Avg. Velocity = 2.43 fps, Avg. Travel Time= 1.2 min

Peak Storage= 114 cf @ 0.14 hrs
Average Depth at Peak Storage= 0.59' , Surface Width= 1.47'
Bank-Full Depth= 1.50' Flow Area= 1.8 sf, Capacity= 11.95 cfs

18.0" Round Pipe
n= 0.013 Corrugated PE, smooth interior
Length= 177.0' Slope= 0.0129 '/'
Inlet Invert= 406.85', Outlet Invert= 404.56'

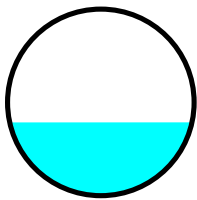

Reach P-A2: Pipe A2

Hydrograph

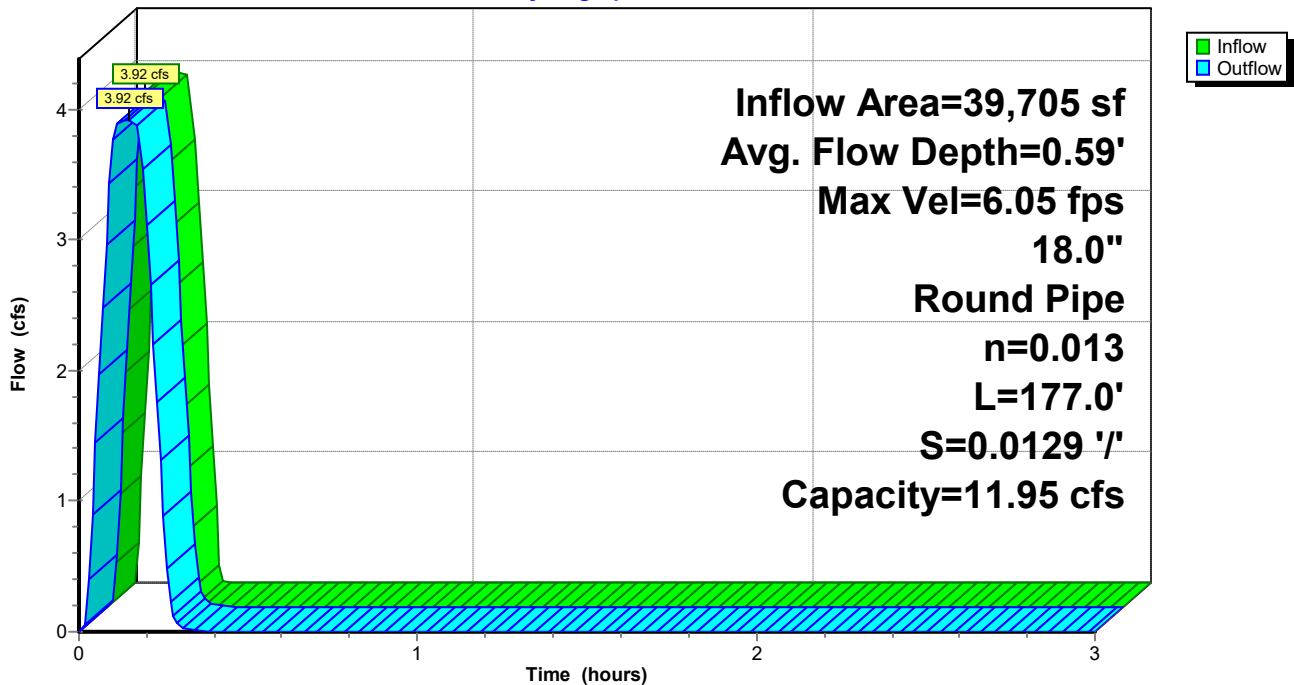

Summerwood Gym 3

Prepared by Phillip Lewis Engineering

HydroCAD® 10.20-2f s/n 12520 © 2022 HydroCAD Software Solutions LLC

AR - Little Rock 5-yr Duration=10 min, Inten=5.17 in/hr

Printed 1/11/2024

Reach P-A2: Pipe A2

Stage-Discharge

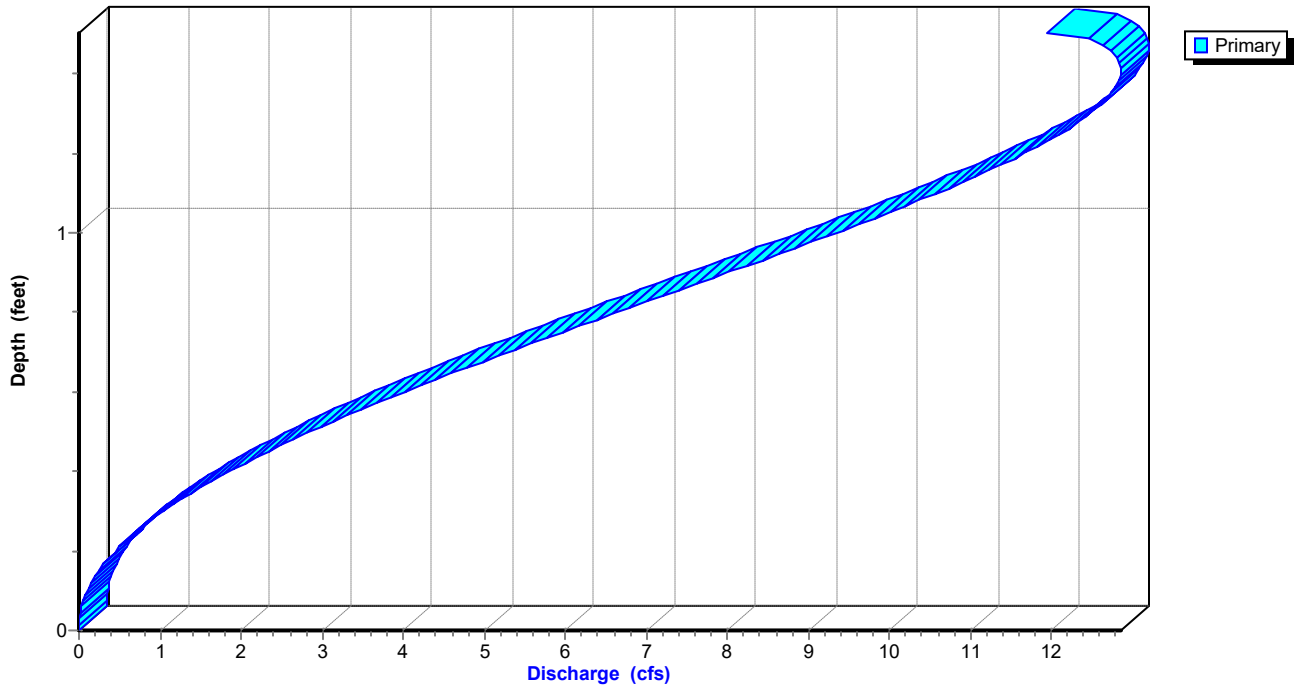

Summerwood Gym 3*AR - Little Rock 5-yr Duration=10 min, Inten=5.17 in/hr*

Prepared by Phillip Lewis Engineering

Printed 1/11/2024

HydroCAD® 10.20-2f s/n 12520 © 2022 HydroCAD Software Solutions LLC

Stage-Area-Storage for Reach P-A2: Pipe A2

Elevation (feet)	End-Area (sq-ft)	Storage (cubic-feet)	Elevation (feet)	End-Area (sq-ft)	Storage (cubic-feet)
406.85	0.0	0	407.89	1.3	231
406.87	0.0	1	407.91	1.3	236
406.89	0.0	2	407.93	1.4	241
406.91	0.0	4	407.95	1.4	246
406.93	0.0	6	407.97	1.4	250
406.95	0.1	9	407.99	1.4	255
406.97	0.1	12	408.01	1.5	260
406.99	0.1	15	408.03	1.5	264
407.01	0.1	18	408.05	1.5	268
407.03	0.1	21	408.07	1.5	272
407.05	0.1	25	408.09	1.6	277
407.07	0.2	28	408.11	1.6	280
407.09	0.2	32	408.13	1.6	284
407.11	0.2	36	408.15	1.6	288
407.13	0.2	40	408.17	1.6	292
407.15	0.3	45	408.19	1.7	295
407.17	0.3	49	408.21	1.7	298
407.19	0.3	53	408.23	1.7	301
407.21	0.3	58	408.25	1.7	304
407.23	0.4	62	408.27	1.7	306
407.25	0.4	67	408.29	1.7	309
407.27	0.4	72	408.31	1.8	310
407.29	0.4	76	408.33	1.8	312
407.31	0.5	81	408.35	1.8	313
407.33	0.5	86			
407.35	0.5	91			
407.37	0.5	96			
407.39	0.6	101			
407.41	0.6	106			
407.43	0.6	112			
407.45	0.7	117			
407.47	0.7	122			
407.49	0.7	127			
407.51	0.7	133			
407.53	0.8	138			
407.55	0.8	143			
407.57	0.8	148			
407.59	0.9	154			
407.61	0.9	159			
407.63	0.9	164			
407.65	1.0	170			
407.67	1.0	175			
407.69	1.0	180			
407.71	1.0	185			
407.73	1.1	191			
407.75	1.1	196			
407.77	1.1	201			
407.79	1.2	206			
407.81	1.2	211			
407.83	1.2	216			
407.85	1.3	222			
407.87	1.3	226			

Summerwood Gym 3

Prepared by Phillip Lewis Engineering

HydroCAD® 10.20-2f s/n 12520 © 2022 HydroCAD Software Solutions LLC

AR - Little Rock 5-yr Duration=10 min, Inten=5.17 in/hr

Printed 1/11/2024

Summary for Reach P-A3: Pipe A3

Inflow Area = 71,768 sf, 58.28% Impervious, Inflow Depth = 0.63" for 5-yr event
Inflow = 6.22 cfs @ 0.17 hrs, Volume= 3,751 cf
Outflow = 6.17 cfs @ 0.17 hrs, Volume= 3,751 cf, Atten= 1%, Lag= 0.3 min
Routed to Reach P-A4 : Pipe A4

Routing by Stor-Ind+Trans method, Time Span= 0.00-3.00 hrs, dt= 0.01 hrs
Max. Velocity= 9.11 fps, Min. Travel Time= 0.2 min
Avg. Velocity = 3.79 fps, Avg. Travel Time= 0.5 min

Peak Storage= 80 cf @ 0.17 hrs
Average Depth at Peak Storage= 0.61' , Surface Width= 1.48'
Bank-Full Depth= 1.50' Flow Area= 1.8 sf, Capacity= 17.65 cfs

18.0" Round Pipe
n= 0.013 Corrugated PE, smooth interior
Length= 118.0' Slope= 0.0282 '/'
Inlet Invert= 404.46', Outlet Invert= 401.13'

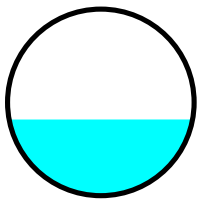

Reach P-A3: Pipe A3

Hydrograph

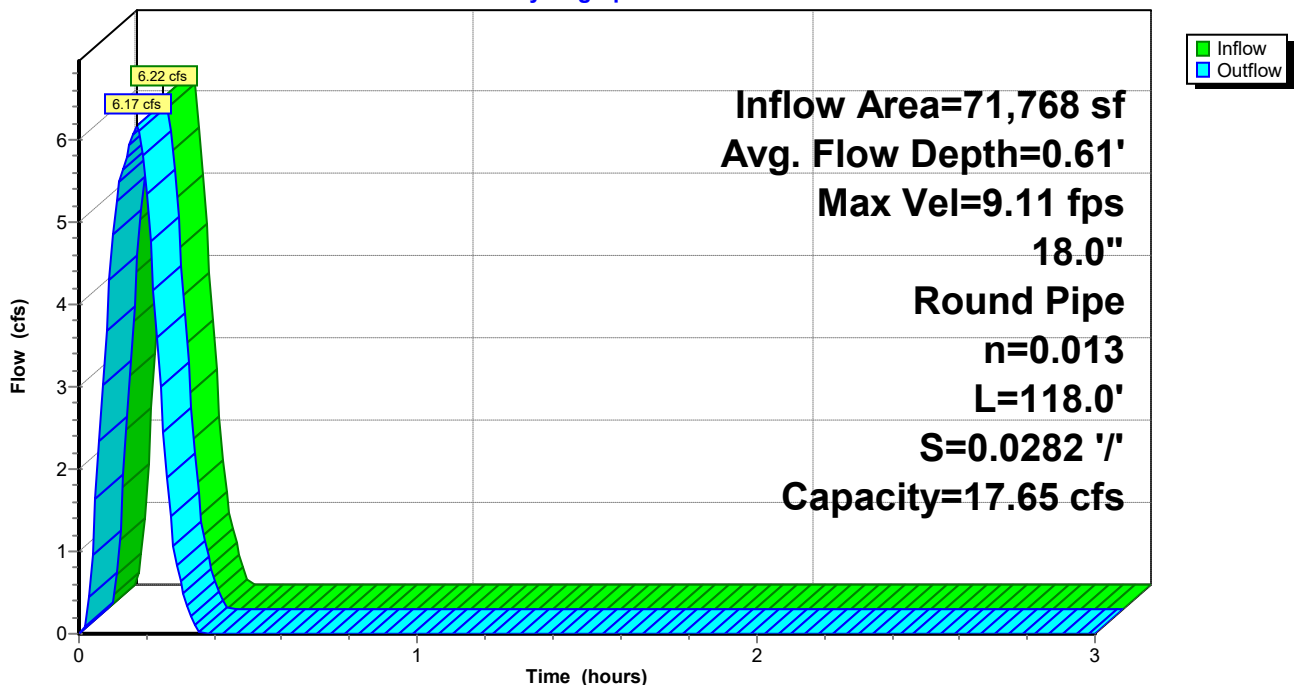

Summerwood Gym 3

Prepared by Phillip Lewis Engineering

HydroCAD® 10.20-2f s/n 12520 © 2022 HydroCAD Software Solutions LLC

AR - Little Rock 5-yr Duration=10 min, Inten=5.17 in/hr

Printed 1/11/2024

Reach P-A3: Pipe A3

Stage-Discharge

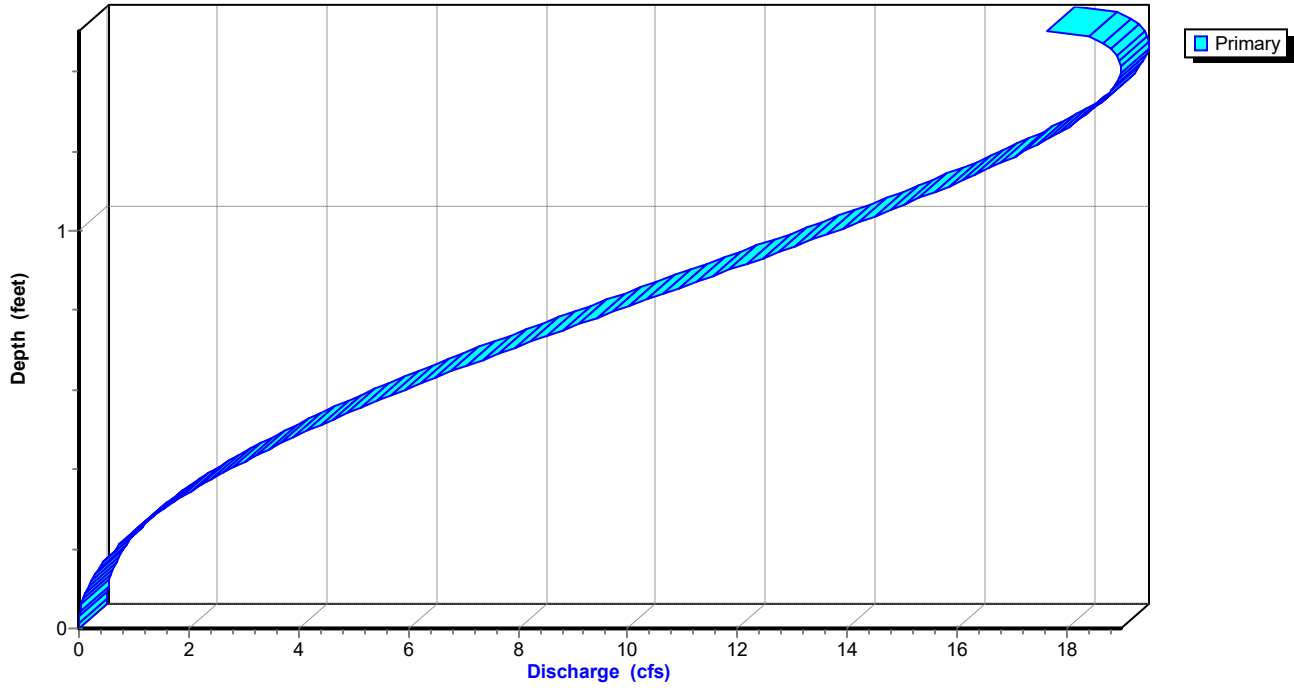

Summerwood Gym 3*AR - Little Rock 5-yr Duration=10 min, Inten=5.17 in/hr*

Prepared by Phillip Lewis Engineering

Printed 1/11/2024

HydroCAD® 10.20-2f s/n 12520 © 2022 HydroCAD Software Solutions LLC

Stage-Area-Storage for Reach P-A3: Pipe A3

Elevation (feet)	End-Area (sq-ft)	Storage (cubic-feet)	Elevation (feet)	End-Area (sq-ft)	Storage (cubic-feet)
404.46	0.0	0	405.50	1.3	154
404.48	0.0	1	405.52	1.3	158
404.50	0.0	2	405.54	1.4	161
404.52	0.0	3	405.56	1.4	164
404.54	0.0	4	405.58	1.4	167
404.56	0.1	6	405.60	1.4	170
404.58	0.1	8	405.62	1.5	173
404.60	0.1	10	405.64	1.5	176
404.62	0.1	12	405.66	1.5	179
404.64	0.1	14	405.68	1.5	182
404.66	0.1	17	405.70	1.6	184
404.68	0.2	19	405.72	1.6	187
404.70	0.2	22	405.74	1.6	190
404.72	0.2	24	405.76	1.6	192
404.74	0.2	27	405.78	1.6	194
404.76	0.3	30	405.80	1.7	197
404.78	0.3	33	405.82	1.7	199
404.80	0.3	35	405.84	1.7	201
404.82	0.3	38	405.86	1.7	203
404.84	0.4	42	405.88	1.7	204
404.86	0.4	45	405.90	1.7	206
404.88	0.4	48	405.92	1.8	207
404.90	0.4	51	405.94	1.8	208
404.92	0.5	54	405.96	1.8	209
404.94	0.5	58			
404.96	0.5	61			
404.98	0.5	64			
405.00	0.6	68			
405.02	0.6	71			
405.04	0.6	74			
405.06	0.7	78			
405.08	0.7	81			
405.10	0.7	85			
405.12	0.7	88			
405.14	0.8	92			
405.16	0.8	95			
405.18	0.8	99			
405.20	0.9	102			
405.22	0.9	106			
405.24	0.9	110			
405.26	1.0	113			
405.28	1.0	117			
405.30	1.0	120			
405.32	1.0	124			
405.34	1.1	127			
405.36	1.1	131			
405.38	1.1	134			
405.40	1.2	138			
405.42	1.2	141			
405.44	1.2	144			
405.46	1.3	148			
405.48	1.3	151			

Summerwood Gym 3

Prepared by Phillip Lewis Engineering

HydroCAD® 10.20-2f s/n 12520 © 2022 HydroCAD Software Solutions LLC

AR - Little Rock 5-yr Duration=10 min, Inten=5.17 in/hr

Printed 1/11/2024

Summary for Reach P-A4: Pipe A4

Inflow Area = 71,768 sf, 58.28% Impervious, Inflow Depth = 0.63" for 5-yr event
Inflow = 6.17 cfs @ 0.17 hrs, Volume= 3,751 cf
Outflow = 6.15 cfs @ 0.18 hrs, Volume= 3,751 cf, Atten= 0%, Lag= 0.4 min
Routed to Pond DP1 : Re-Established East Pond

Routing by Stor-Ind+Trans method, Time Span= 0.00-3.00 hrs, dt= 0.01 hrs
Max. Velocity= 9.09 fps, Min. Travel Time= 0.2 min
Avg. Velocity = 3.60 fps, Avg. Travel Time= 0.6 min

Peak Storage= 89 cf @ 0.17 hrs
Average Depth at Peak Storage= 0.61' , Surface Width= 1.47'
Bank-Full Depth= 1.50' Flow Area= 1.8 sf, Capacity= 17.66 cfs

18.0" Round Pipe
n= 0.013 Corrugated PE, smooth interior
Length= 132.0' Slope= 0.0283 '/'
Inlet Invert= 401.03', Outlet Invert= 397.30'

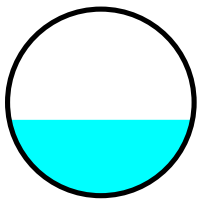

Reach P-A4: Pipe A4

Hydrograph

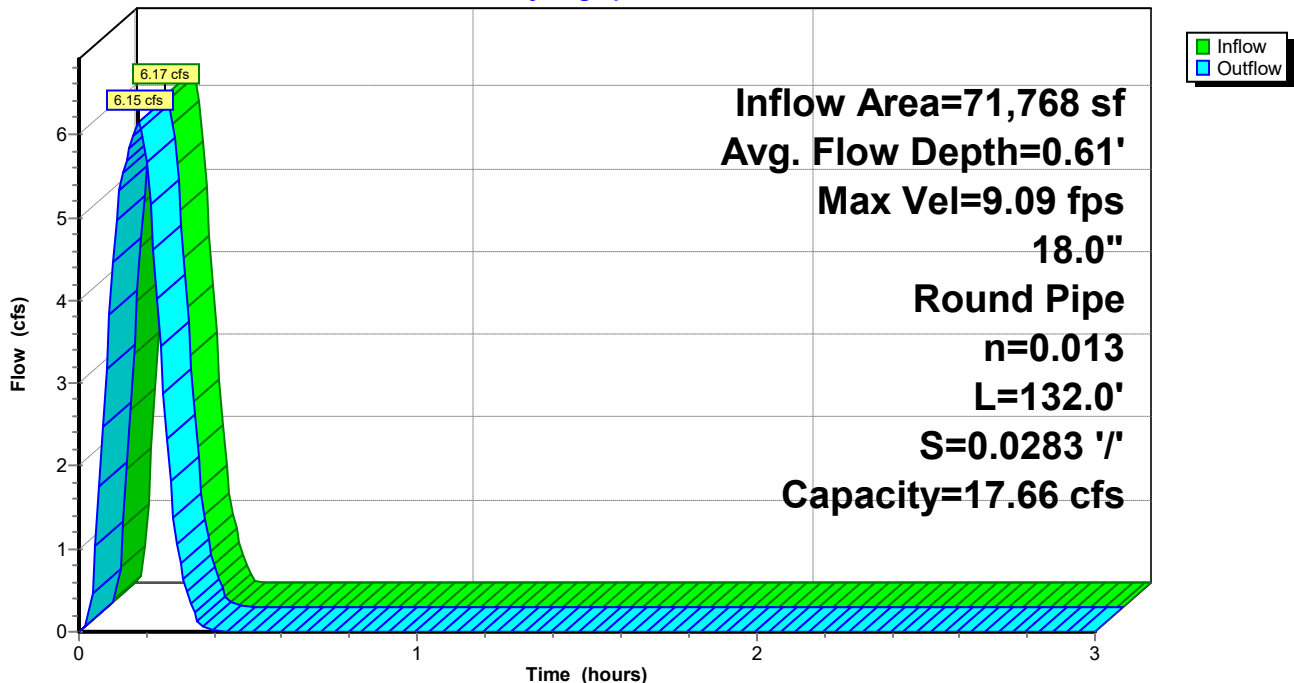

Reach P-A4: Pipe A4

Stage-Discharge

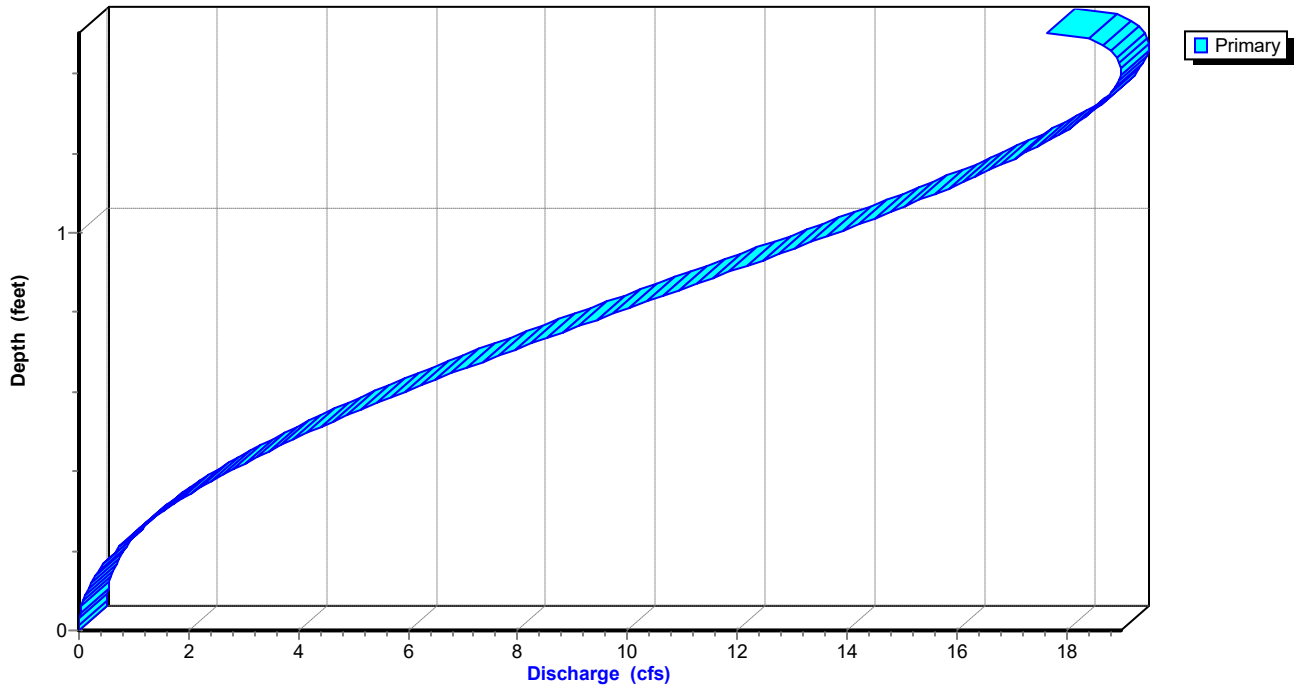

Summerwood Gym 3*AR - Little Rock 5-yr Duration=10 min, Inten=5.17 in/hr*

Prepared by Phillip Lewis Engineering

Printed 1/11/2024

HydroCAD® 10.20-2f s/n 12520 © 2022 HydroCAD Software Solutions LLC

Stage-Area-Storage for Reach P-A4: Pipe A4

Elevation (feet)	End-Area (sq-ft)	Storage (cubic-feet)	Elevation (feet)	End-Area (sq-ft)	Storage (cubic-feet)
401.03	0.0	0	402.07	1.3	173
401.05	0.0	1	402.09	1.3	176
401.07	0.0	2	402.11	1.4	180
401.09	0.0	3	402.13	1.4	183
401.11	0.0	5	402.15	1.4	187
401.13	0.1	7	402.17	1.4	190
401.15	0.1	9	402.19	1.5	194
401.17	0.1	11	402.21	1.5	197
401.19	0.1	13	402.23	1.5	200
401.21	0.1	16	402.25	1.5	203
401.23	0.1	18	402.27	1.6	206
401.25	0.2	21	402.29	1.6	209
401.27	0.2	24	402.31	1.6	212
401.29	0.2	27	402.33	1.6	215
401.31	0.2	30	402.35	1.6	217
401.33	0.3	33	402.37	1.7	220
401.35	0.3	36	402.39	1.7	222
401.37	0.3	40	402.41	1.7	225
401.39	0.3	43	402.43	1.7	227
401.41	0.4	46	402.45	1.7	228
401.43	0.4	50	402.47	1.7	230
401.45	0.4	53	402.49	1.8	232
401.47	0.4	57	402.51	1.8	233
401.49	0.5	61	402.53	1.8	233
401.51	0.5	64			
401.53	0.5	68			
401.55	0.5	72			
401.57	0.6	76			
401.59	0.6	79			
401.61	0.6	83			
401.63	0.7	87			
401.65	0.7	91			
401.67	0.7	95			
401.69	0.7	99			
401.71	0.8	103			
401.73	0.8	107			
401.75	0.8	111			
401.77	0.9	115			
401.79	0.9	119			
401.81	0.9	123			
401.83	1.0	127			
401.85	1.0	130			
401.87	1.0	134			
401.89	1.0	138			
401.91	1.1	142			
401.93	1.1	146			
401.95	1.1	150			
401.97	1.2	154			
401.99	1.2	158			
402.01	1.2	161			
402.03	1.3	165			
402.05	1.3	169			

Summerwood Gym 3

AR - Little Rock 5-yr Duration=10 min, Inten=5.17 in/hr

Prepared by Phillip Lewis Engineering

Printed 1/11/2024

HydroCAD® 10.20-2f s/n 12520 © 2022 HydroCAD Software Solutions LLC

Summary for Pond DP1: Re-Established East Pond

Inflow Area = 132,514 sf, 61.41% Impervious, Inflow Depth = 0.64" for 5-yr event
Inflow = 11.49 cfs @ 0.16 hrs, Volume= 7,053 cf
Outflow = 6.40 cfs @ 0.22 hrs, Volume= 7,053 cf, Atten= 44%, Lag= 3.6 min
Primary = 6.40 cfs @ 0.22 hrs, Volume= 7,053 cf
Routed to Link Post-Dev : APPROX DISCHARGE

Routing by Stor-Ind method, Time Span= 0.00-3.00 hrs, dt= 0.01 hrs
Peak Elev= 397.93' @ 0.22 hrs Storage= 3,558 cf

Plug-Flow detention time= 8.2 min calculated for 7,053 cf (100% of inflow)
Center-of-Mass det. time= 8.1 min (17.0 - 8.9)

Volume	Invert	Avail.Storage	Storage Description
#1	396.00'	8,557 cf	Custom Stage Data Listed below

Elevation (feet)	Inc.Store (cubic-feet)	Cum.Store (cubic-feet)
396.00	0	0
396.50	250	250
397.00	1,092	1,342
398.00	2,387	3,729
399.00	2,405	6,134
400.00	2,423	8,557

Device	Routing	Invert	Outlet Devices
#1	Primary	399.00'	5.0' long Sharp-Crested Rectangular Weir 2 End Contraction(s)
#2	Primary	396.00'	1.1' long Sharp-Crested Rectangular Weir 2 End Contraction(s) 10.0' Crest Height

Primary OutFlow Max=6.40 cfs @ 0.22 hrs HW=397.93' (Free Discharge)

1=Sharp-Crested Rectangular Weir (Controls 0.00 cfs)

2=Sharp-Crested Rectangular Weir (Weir Controls 6.40 cfs @ 4.65 fps)

Summerwood Gym 3

Prepared by Phillip Lewis Engineering

HydroCAD® 10.20-2f s/n 12520 © 2022 HydroCAD Software Solutions LLC

AR - Little Rock 5-yr Duration=10 min, Inten=5.17 in/hr

Printed 1/11/2024

Pond DP1: Re-Established East Pond

Hydrograph

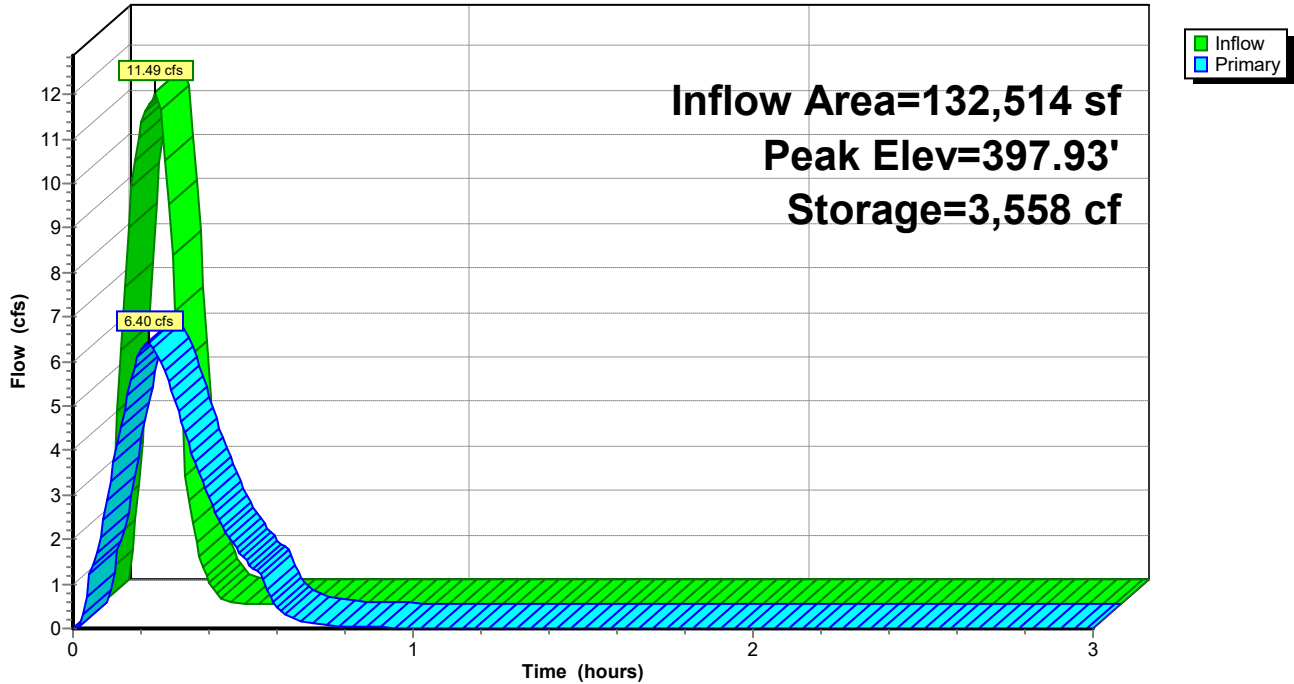

Pond DP1: Re-Established East Pond

Stage-Discharge

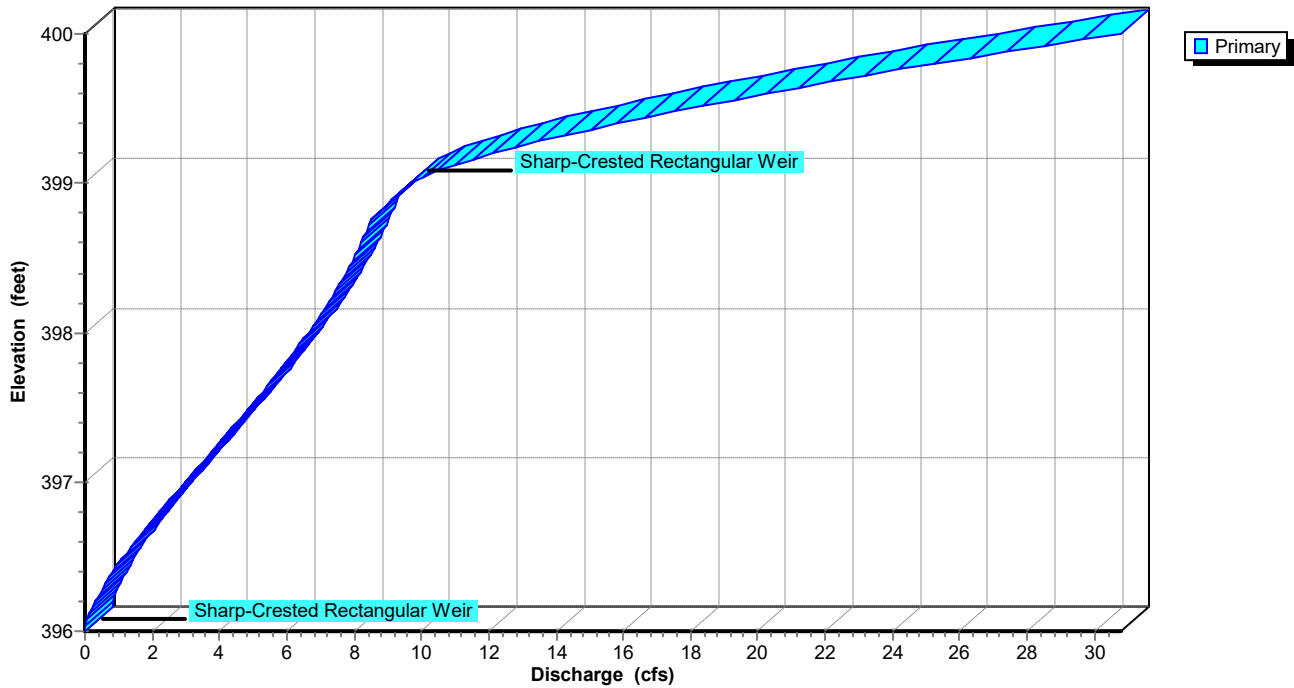

Summerwood Gym 3*AR - Little Rock 5-yr Duration=10 min, Inten=5.17 in/hr*

Prepared by Phillip Lewis Engineering

Printed 1/11/2024

HydroCAD® 10.20-2f s/n 12520 © 2022 HydroCAD Software Solutions LLC

Stage-Area-Storage for Pond DP1: Re-Established East Pond

Elevation (feet)	Storage (cubic-feet)	Elevation (feet)	Storage (cubic-feet)
396.00	0	398.60	5,172
396.05	25	398.65	5,292
396.10	50	398.70	5,412
396.15	75	398.75	5,533
396.20	100	398.80	5,653
396.25	125	398.85	5,773
396.30	150	398.90	5,893
396.35	175	398.95	6,014
396.40	200	399.00	6,134
396.45	225	399.05	6,255
396.50	250	399.10	6,376
396.55	359	399.15	6,497
396.60	468	399.20	6,619
396.65	578	399.25	6,740
396.70	687	399.30	6,861
396.75	796	399.35	6,982
396.80	905	399.40	7,103
396.85	1,014	399.45	7,224
396.90	1,124	399.50	7,346
396.95	1,233	399.55	7,467
397.00	1,342	399.60	7,588
397.05	1,461	399.65	7,709
397.10	1,581	399.70	7,830
397.15	1,700	399.75	7,951
397.20	1,819	399.80	8,072
397.25	1,939	399.85	8,194
397.30	2,058	399.90	8,315
397.35	2,177	399.95	8,436
397.40	2,297	400.00	8,557
397.45	2,416		
397.50	2,536		
397.55	2,655		
397.60	2,774		
397.65	2,894		
397.70	3,013		
397.75	3,132		
397.80	3,252		
397.85	3,371		
397.90	3,490		
397.95	3,610		
398.00	3,729		
398.05	3,849		
398.10	3,970		
398.15	4,090		
398.20	4,210		
398.25	4,330		
398.30	4,451		
398.35	4,571		
398.40	4,691		
398.45	4,811		
398.50	4,932		
398.55	5,052		

Summerwood Gym 3

AR - Little Rock 5-yr Duration=10 min, Inten=5.17 in/hr

Prepared by Phillip Lewis Engineering

Printed 1/11/2024

HydroCAD® 10.20-2f s/n 12520 © 2022 HydroCAD Software Solutions LLC

Summary for Link Post-Dev: APPROX DISCHARGE

Inflow Area = 206,166 sf, 64.42% Impervious, Inflow Depth = 0.65" for 5-yr event
Inflow = 12.27 cfs @ 0.17 hrs, Volume= 11,197 cf
Primary = 12.27 cfs @ 0.17 hrs, Volume= 11,197 cf, Atten= 0%, Lag= 0.0 min

Primary outflow = Inflow, Time Span= 0.00-3.00 hrs, dt= 0.01 hrs

Link Post-Dev: APPROX DISCHARGE

Hydrograph

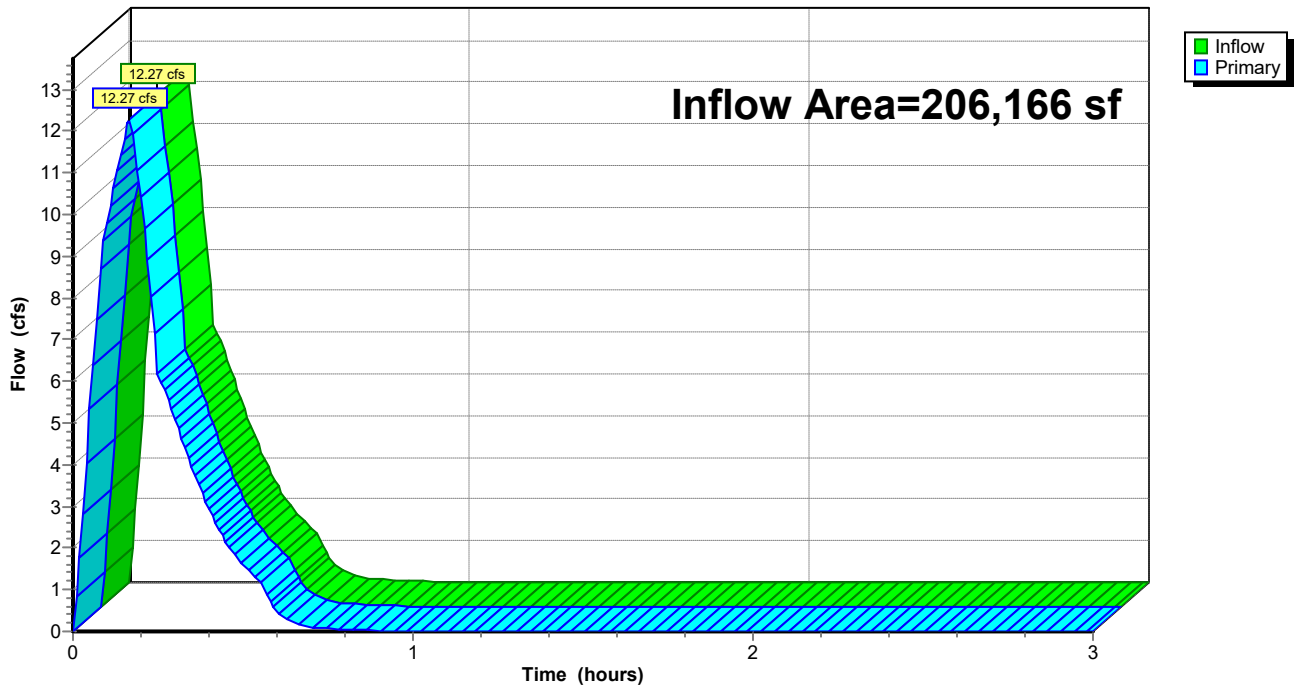

Summerwood Gym 3

Prepared by Phillip Lewis Engineering

HydroCAD® 10.20-2f s/n 12520 © 2022 HydroCAD Software Solutions LLC

AR - Little Rock 10-yr Duration=10 min, Inten=5.83 in/hr

Printed 1/11/2024

Summary for Subcatchment D1: Drainage Basin D1

Runoff = 5.97 cfs @ 0.09 hrs, Volume= 3,577 cf, Depth= 0.88"
 Routed to Link Post-Dev : APPROX DISCHARGE

Runoff by Rational method, Rise/Fall=1.0/1.0 xTc, Time Span= 0.00-3.00 hrs, dt= 0.01 hrs
 AR - Little Rock 10-yr Duration=10 min, Inten=5.83 in/hr

Area (sf)	C	Description
3,421	0.40	Sod Yard
45,236	0.95	Road, Drives, Sidewalks
48,657	0.91	Weighted Average
3,421		7.03% Pervious Area
45,236		92.97% Impervious Area

Tc (min)	Length (feet)	Slope (ft/ft)	Velocity (ft/sec)	Capacity (cfs)	Description
5.0					Direct Entry, Overland Concentrated Flow (Min)

Subcatchment D1: Drainage Basin D1

Hydrograph

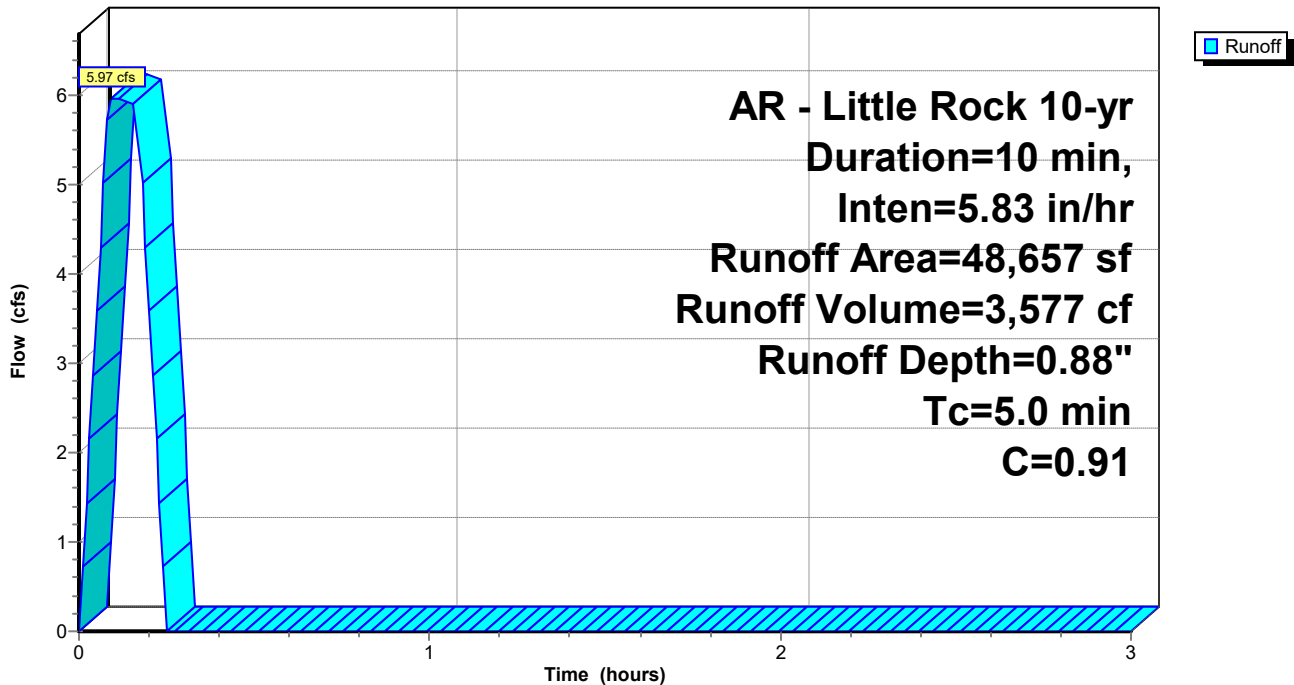

Summerwood Gym 3

Prepared by Phillip Lewis Engineering

HydroCAD® 10.20-2f s/n 12520 © 2022 HydroCAD Software Solutions LLC

AR - Little Rock 10-yr Duration=10 min, Inten=5.83 in/hr

Printed 1/11/2024

Summary for Subcatchment D2: Drainage Basin D2

Runoff = 2.53 cfs @ 0.09 hrs, Volume= 1,519 cf, Depth= 0.75"

Routed to Reach P-A1 : Pipe A1

Runoff by Rational method, Rise/Fall=1.0/1.0 xTc, Time Span= 0.00-3.00 hrs, dt= 0.01 hrs

AR - Little Rock 10-yr Duration=10 min, Inten=5.83 in/hr

Area (sf)	C	Description
8,845	0.45	Rip Rap Embankment
15,566	0.95	Roof, Drives, Sidewalks
24,411	0.77	Weighted Average
8,845		36.23% Pervious Area
15,566		63.77% Impervious Area

Tc (min)	Length (feet)	Slope (ft/ft)	Velocity (ft/sec)	Capacity (cfs)	Description
5.0	415		1.38		Direct Entry, Overland Concentrated Flow (Min)

Subcatchment D2: Drainage Basin D2

Hydrograph

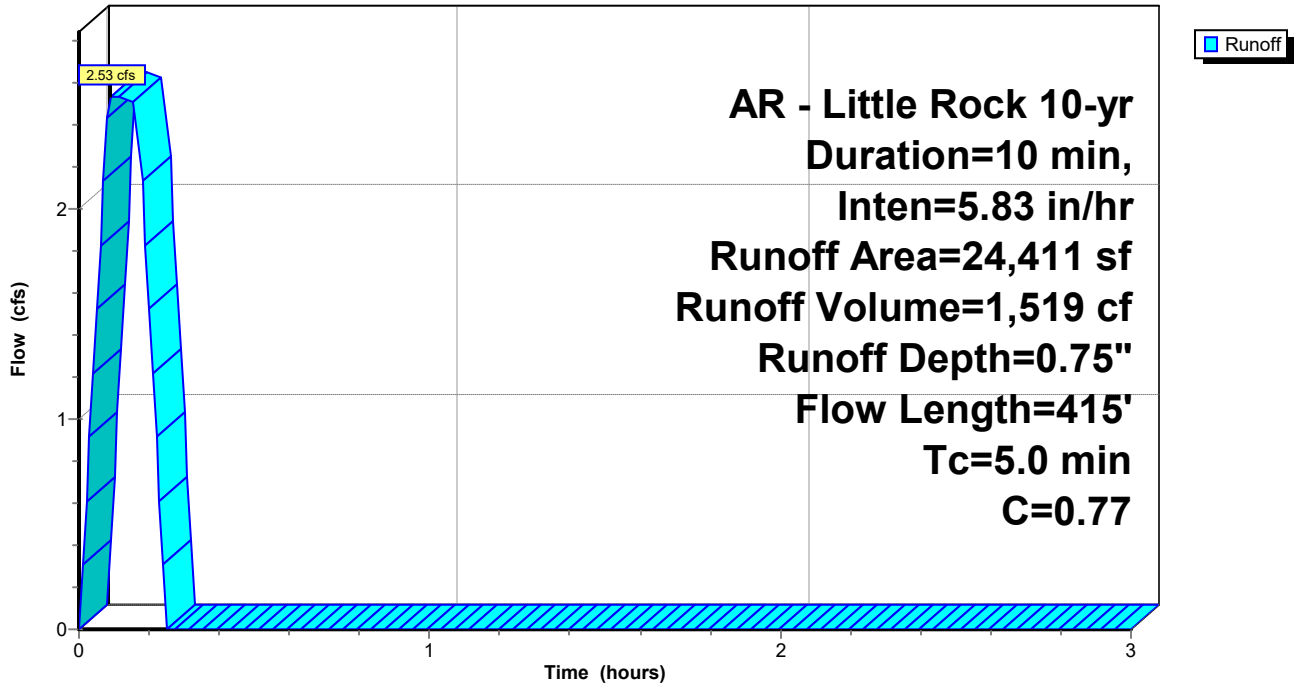

Summerwood Gym 3

Prepared by Phillip Lewis Engineering

HydroCAD® 10.20-2f s/n 12520 © 2022 HydroCAD Software Solutions LLC

AR - Little Rock 10-yr Duration=10 min, Inten=5.83 in/hr

Printed 1/11/2024

Summary for Subcatchment D3: Drainage Basin D3

Runoff = 1.88 cfs @ 0.09 hrs, Volume= 1,124 cf, Depth= 0.88"

Routed to Reach P-A2 : Pipe A2

Runoff by Rational method, Rise/Fall=1.0/1.0 xTc, Time Span= 0.00-3.00 hrs, dt= 0.01 hrs

AR - Little Rock 10-yr Duration=10 min, Inten=5.83 in/hr

Area (sf)	C	Description
1,065	0.40	Sod Yard
14,229	0.95	Paving, Sidewalks
15,294	0.91	Weighted Average
1,065		6.96% Pervious Area
14,229		93.04% Impervious Area

Tc (min)	Length (feet)	Slope (ft/ft)	Velocity (ft/sec)	Capacity (cfs)	Description
5.0	415		1.38		Direct Entry, Overland Concentrated Flow (Min)

Subcatchment D3: Drainage Basin D3

Hydrograph

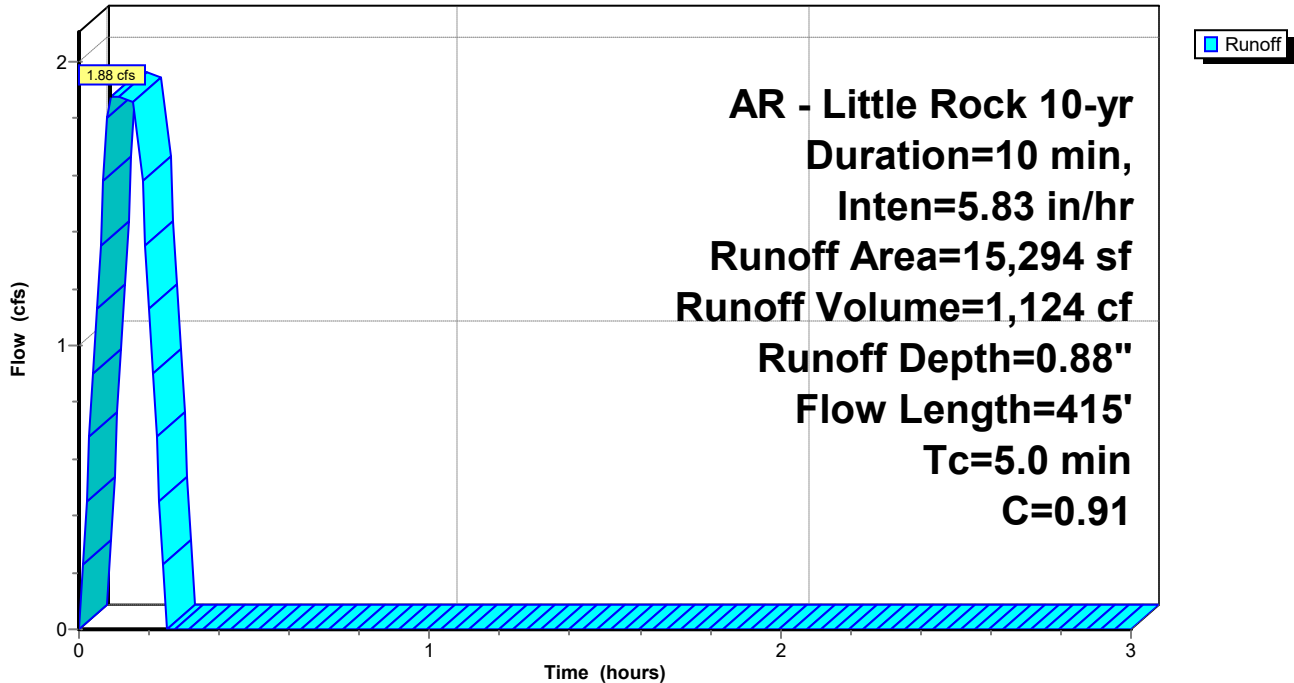

Summerwood Gym 3

Prepared by Phillip Lewis Engineering

HydroCAD® 10.20-2f s/n 12520 © 2022 HydroCAD Software Solutions LLC

AR - Little Rock 10-yr Duration=10 min, Inten=5.83 in/hr

Printed 1/11/2024

Summary for Subcatchment D4: Drainage Basin D4

Runoff = 2.59 cfs @ 0.17 hrs, Volume= 1,582 cf, Depth= 0.59"

Routed to Reach P-A3 : Pipe A3

Runoff by Rational method, Rise/Fall=1.0/1.0 xTc, Time Span= 0.00-3.00 hrs, dt= 0.01 hrs

AR - Little Rock 10-yr Duration=10 min, Inten=5.83 in/hr

Area (sf)	C	Description
20,032	0.40	
12,031	0.95	
32,063	0.61	Weighted Average
20,032		62.48% Pervious Area
12,031		37.52% Impervious Area

Tc (min)	Length (feet)	Slope (ft/ft)	Velocity (ft/sec)	Capacity (cfs)	Description
10.0	415		0.69		Direct Entry, Overland Concentrated Flow (Min)

Subcatchment D4: Drainage Basin D4

Hydrograph

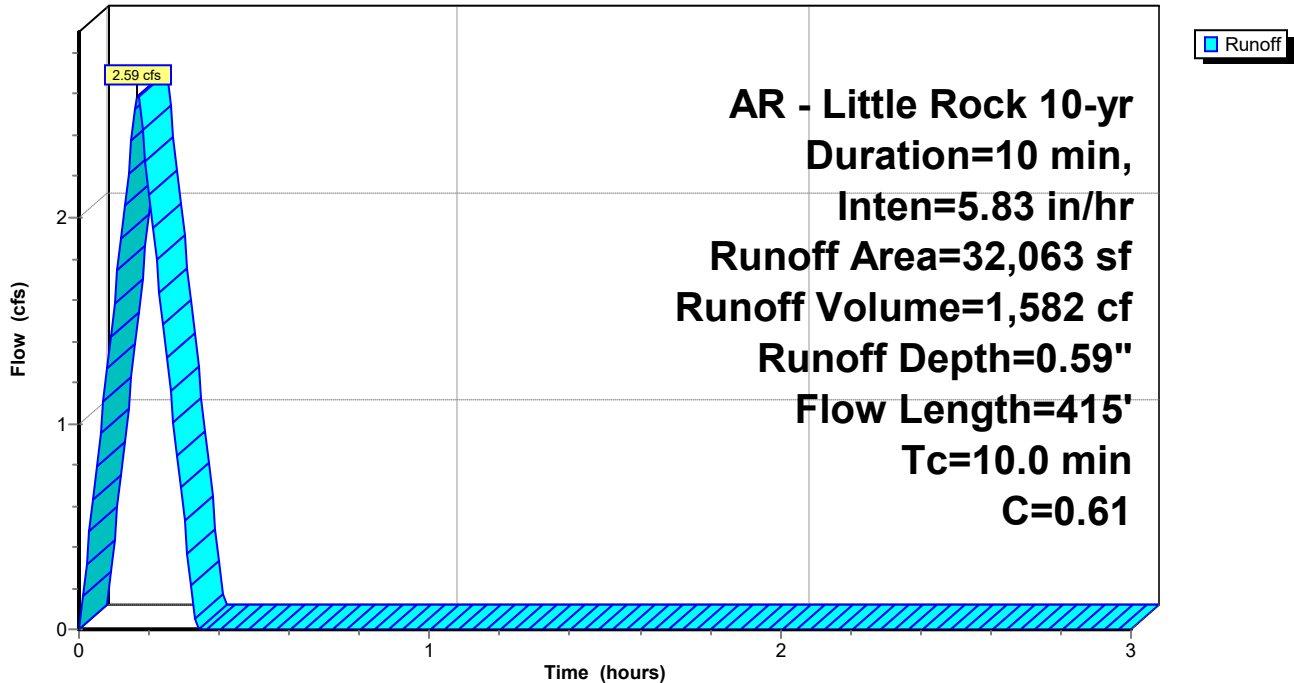

Summerwood Gym 3

Prepared by Phillip Lewis Engineering

HydroCAD® 10.20-2f s/n 12520 © 2022 HydroCAD Software Solutions LLC

AR - Little Rock 10-yr Duration=10 min, Inten=5.83 in/hr

Printed 1/11/2024

Summary for Subcatchment D5: Drainage Basin D5

Runoff = 3.76 cfs @ 0.09 hrs, Volume= 2,254 cf, Depth= 0.65"
 Routed to Pond DP1 : Re-Established East Pond

Runoff by Rational method, Rise/Fall=1.0/1.0 xTc, Time Span= 0.00-3.00 hrs, dt= 0.01 hrs
 AR - Little Rock 10-yr Duration=10 min, Inten=5.83 in/hr

Area (sf)	C	Description
21,201	0.40	Sod Yard, Natural Vegetation
20,437	0.95	Paving, Sidewalks
41,638	0.67	Weighted Average
21,201		50.92% Pervious Area
20,437		49.08% Impervious Area

Tc (min)	Length (feet)	Slope (ft/ft)	Velocity (ft/sec)	Capacity (cfs)	Description
5.0					Direct Entry, Overland Concentrated Flow (Min)

Subcatchment D5: Drainage Basin D5

Hydrograph

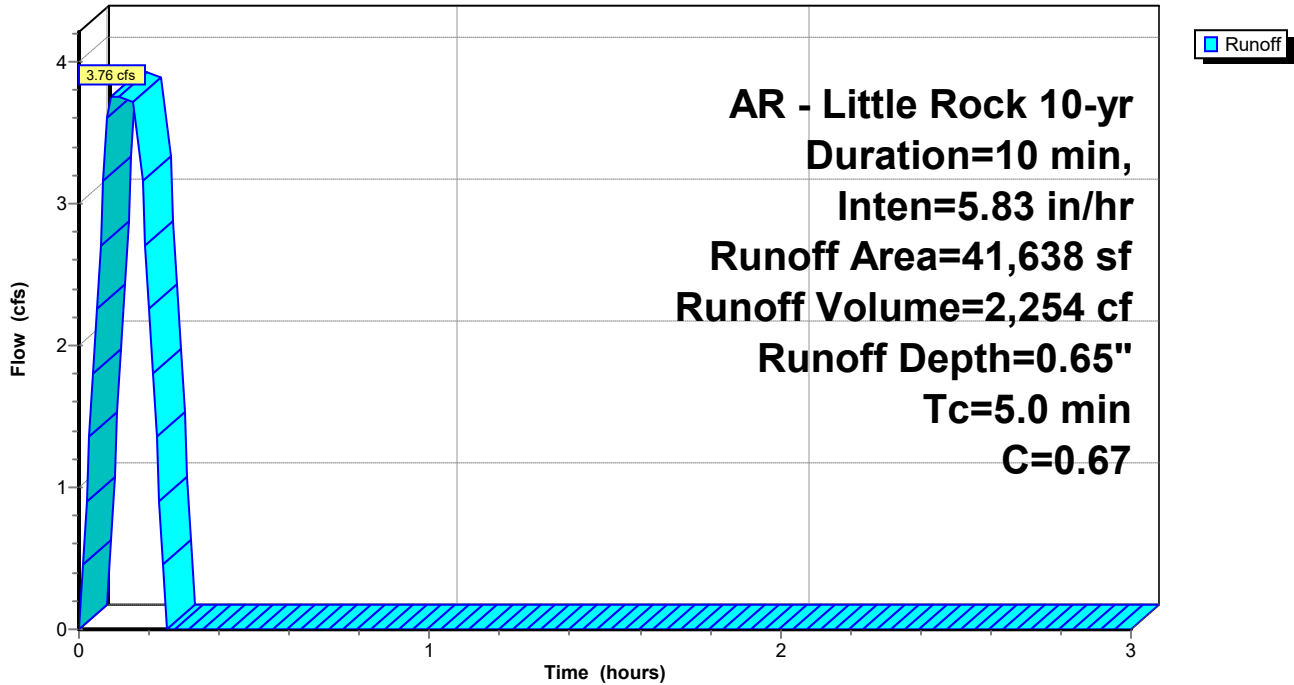

Summerwood Gym 3

Prepared by Phillip Lewis Engineering

HydroCAD® 10.20-2f s/n 12520 © 2022 HydroCAD Software Solutions LLC

AR - Little Rock 10-yr Duration=10 min, Inten=5.83 in/hr

Printed 1/11/2024

Summary for Subcatchment D6: Drainage Basin D6

Runoff = 2.45 cfs @ 0.09 hrs, Volume= 1,466 cf, Depth= 0.92"

Routed to Pond DP1 : Re-Established East Pond

Runoff by Rational method, Rise/Fall=1.0/1.0 xTc, Time Span= 0.00-3.00 hrs, dt= 0.01 hrs

AR - Little Rock 10-yr Duration=10 min, Inten=5.83 in/hr

Area (sf)	C	Description
19,108	0.95	Roof
19,108		100.00% Impervious Area

Tc (min)	Length (feet)	Slope (ft/ft)	Velocity (ft/sec)	Capacity (cfs)	Description
5.0					Direct Entry, Overland Concentrated Flow (Min)

Subcatchment D6: Drainage Basin D6

Hydrograph

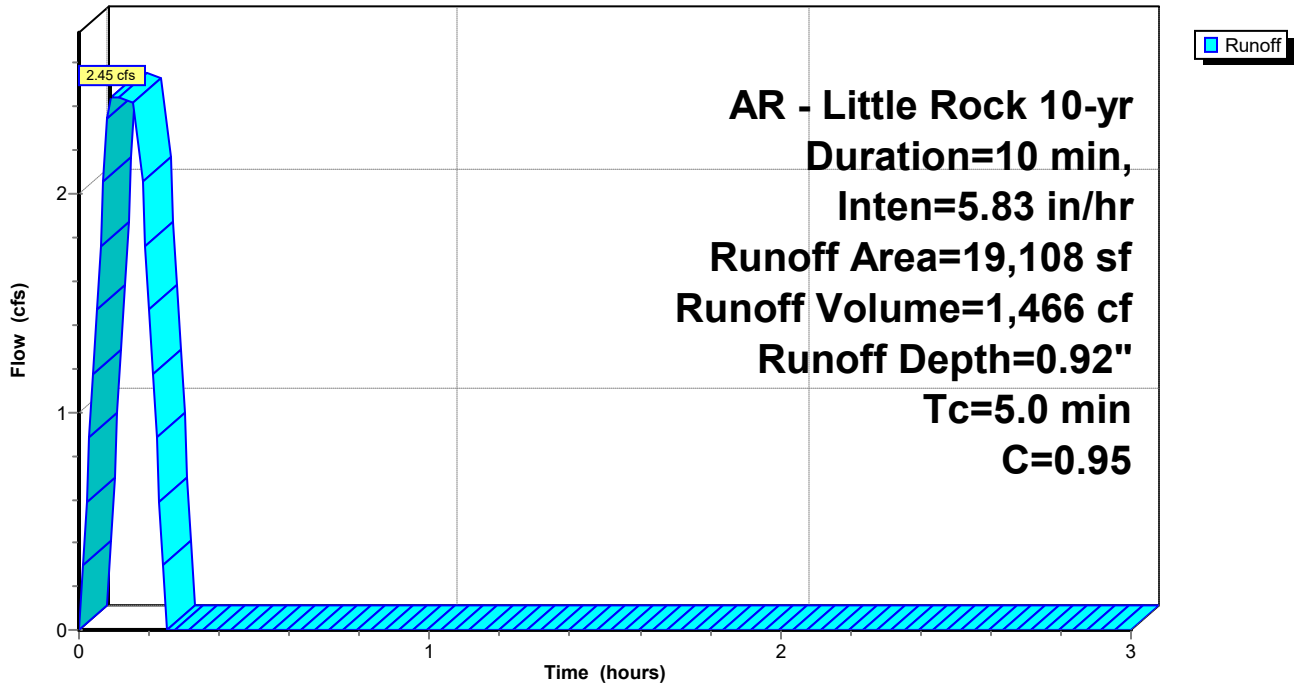

Summerwood Gym 3

Prepared by Phillip Lewis Engineering

HydroCAD® 10.20-2f s/n 12520 © 2022 HydroCAD Software Solutions LLC

AR - Little Rock 10-yr Duration=10 min, Inten=5.83 in/hr

Printed 1/11/2024

Summary for Subcatchment D7: Drainage Basin D7

Runoff = 1.82 cfs @ 0.09 hrs, Volume= 1,090 cf, Depth= 0.52"
 Routed to Link Post-Dev : APPROX DISCHARGE

Runoff by Rational method, Rise/Fall=1.0/1.0 xTc, Time Span= 0.00-3.00 hrs, dt= 0.01 hrs
 AR - Little Rock 10-yr Duration=10 min, Inten=5.83 in/hr

Area (sf)	C	Description
18,798	0.40	Sod Yard, Natural Vegetation
6,197	0.95	Paving, Sidewalks
24,995	0.54	Weighted Average
18,798		75.21% Pervious Area
6,197		24.79% Impervious Area

Tc (min)	Length (feet)	Slope (ft/ft)	Velocity (ft/sec)	Capacity (cfs)	Description
5.0					Direct Entry, Overland Concentrated Flow (Min)

Subcatchment D7: Drainage Basin D7

Hydrograph

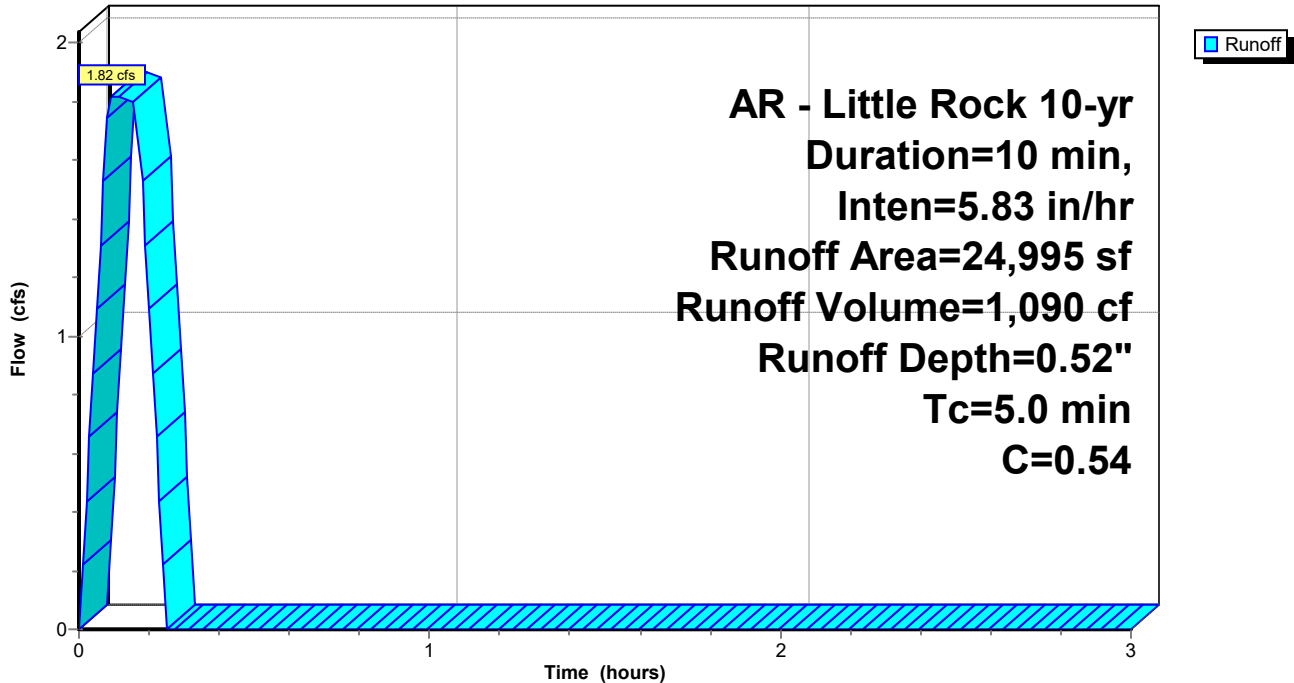

Summerwood Gym 3

Prepared by Phillip Lewis Engineering

HydroCAD® 10.20-2f s/n 12520 © 2022 HydroCAD Software Solutions LLC

AR - Little Rock 10-yr Duration=10 min, Inten=5.83 in/hr

Printed 1/11/2024

Summary for Reach P-A1: Pipe A1

Inflow Area = 24,411 sf, 63.77% Impervious, Inflow Depth = 0.75" for 10-yr event
Inflow = 2.53 cfs @ 0.09 hrs, Volume= 1,519 cf
Outflow = 2.54 cfs @ 0.11 hrs, Volume= 1,519 cf, Atten= 0%, Lag= 1.2 min
Routed to Reach P-A2 : Pipe A2

Routing by Stor-Ind+Trans method, Time Span= 0.00-3.00 hrs, dt= 0.01 hrs
Max. Velocity= 6.99 fps, Min. Travel Time= 0.1 min
Avg. Velocity= 5.09 fps, Avg. Travel Time= 0.2 min

Peak Storage= 19 cf @ 0.09 hrs
Average Depth at Peak Storage= 0.39' , Surface Width= 1.31'
Bank-Full Depth= 1.50' Flow Area= 1.8 sf, Capacity= 17.28 cfs

18.0" Round Pipe
n= 0.013 Corrugated PE, smooth interior
Length= 51.0' Slope= 0.0271 '/'
Inlet Invert= 408.33', Outlet Invert= 406.95'

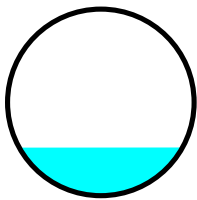

Reach P-A1: Pipe A1

Hydrograph

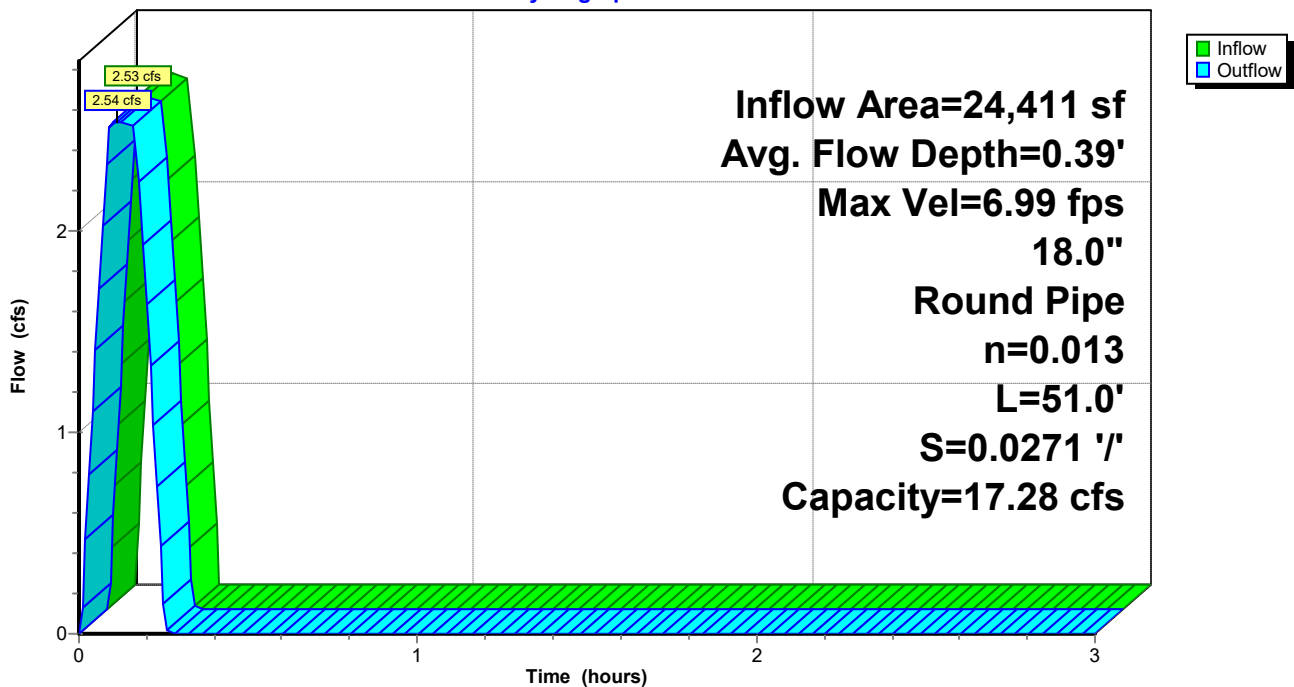

Summerwood Gym 3

Prepared by Phillip Lewis Engineering

HydroCAD® 10.20-2f s/n 12520 © 2022 HydroCAD Software Solutions LLC

AR - Little Rock 10-yr Duration=10 min, Inten=5.83 in/hr

Printed 1/11/2024

Reach P-A1: Pipe A1

Stage-Discharge

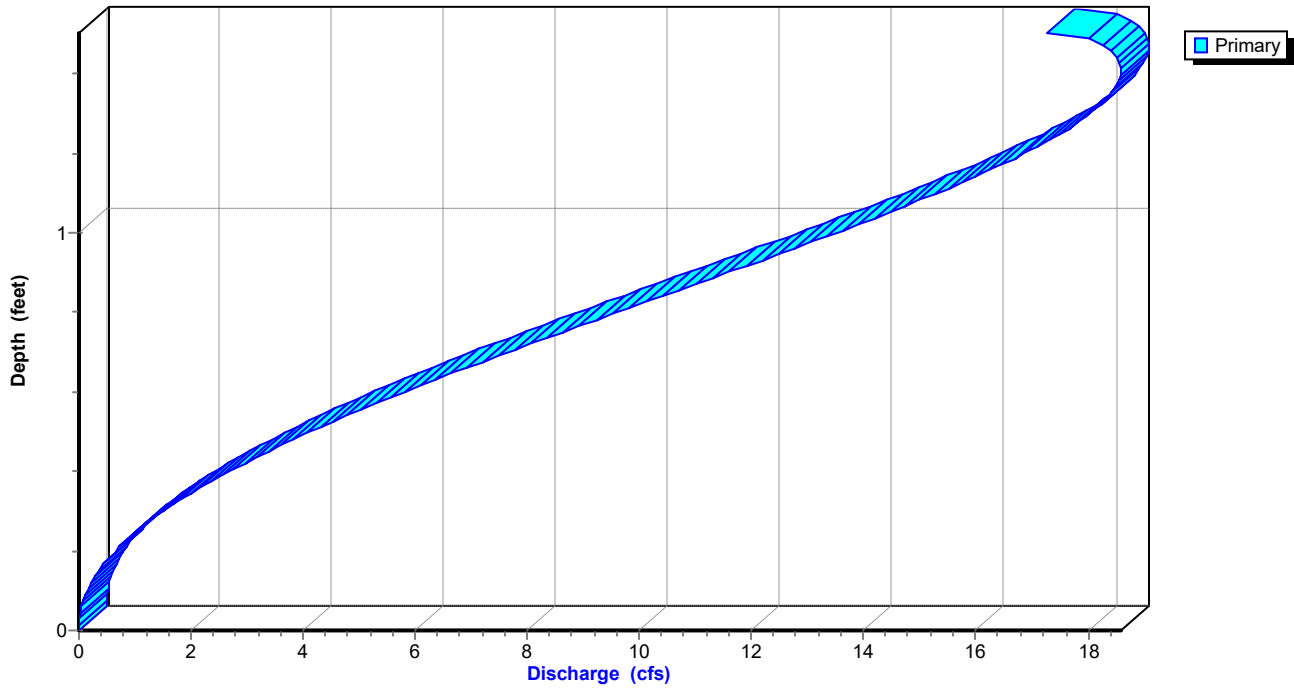

Summerwood Gym 3*AR - Little Rock 10-yr Duration=10 min, Inten=5.83 in/hr*

Prepared by Phillip Lewis Engineering

Printed 1/11/2024

HydroCAD® 10.20-2f s/n 12520 © 2022 HydroCAD Software Solutions LLC

Stage-Area-Storage for Reach P-A1: Pipe A1

Elevation (feet)	End-Area (sq-ft)	Storage (cubic-feet)	Elevation (feet)	End-Area (sq-ft)	Storage (cubic-feet)
408.33	0.0	0	409.37	1.3	67
408.35	0.0	0	409.39	1.3	68
408.37	0.0	1	409.41	1.4	69
408.39	0.0	1	409.43	1.4	71
408.41	0.0	2	409.45	1.4	72
408.43	0.1	3	409.47	1.4	73
408.45	0.1	3	409.49	1.5	75
408.47	0.1	4	409.51	1.5	76
408.49	0.1	5	409.53	1.5	77
408.51	0.1	6	409.55	1.5	78
408.53	0.1	7	409.57	1.6	80
408.55	0.2	8	409.59	1.6	81
408.57	0.2	9	409.61	1.6	82
408.59	0.2	10	409.63	1.6	83
408.61	0.2	12	409.65	1.6	84
408.63	0.3	13	409.67	1.7	85
408.65	0.3	14	409.69	1.7	86
408.67	0.3	15	409.71	1.7	87
408.69	0.3	17	409.73	1.7	88
408.71	0.4	18	409.75	1.7	88
408.73	0.4	19	409.77	1.7	89
408.75	0.4	21	409.79	1.8	89
408.77	0.4	22	409.81	1.8	90
408.79	0.5	23	409.83	1.8	90
408.81	0.5	25			
408.83	0.5	26			
408.85	0.5	28			
408.87	0.6	29			
408.89	0.6	31			
408.91	0.6	32			
408.93	0.7	34			
408.95	0.7	35			
408.97	0.7	37			
408.99	0.7	38			
409.01	0.8	40			
409.03	0.8	41			
409.05	0.8	43			
409.07	0.9	44			
409.09	0.9	46			
409.11	0.9	47			
409.13	1.0	49			
409.15	1.0	50			
409.17	1.0	52			
409.19	1.0	53			
409.21	1.1	55			
409.23	1.1	56			
409.25	1.1	58			
409.27	1.2	59			
409.29	1.2	61			
409.31	1.2	62			
409.33	1.3	64			
409.35	1.3	65			

Summerwood Gym 3

Prepared by Phillip Lewis Engineering

HydroCAD® 10.20-2f s/n 12520 © 2022 HydroCAD Software Solutions LLC

AR - Little Rock 10-yr Duration=10 min, Inten=5.83 in/hr

Printed 1/11/2024

Summary for Reach P-A2: Pipe A2

Inflow Area = 39,705 sf, 75.04% Impervious, Inflow Depth = 0.80" for 10-yr event
Inflow = 4.41 cfs @ 0.11 hrs, Volume= 2,643 cf
Outflow = 4.41 cfs @ 0.15 hrs, Volume= 2,643 cf, Atten= 0%, Lag= 2.4 min
Routed to Reach P-A3 : Pipe A3

Routing by Stor-Ind+Trans method, Time Span= 0.00-3.00 hrs, dt= 0.01 hrs
Max. Velocity= 6.25 fps, Min. Travel Time= 0.5 min
Avg. Velocity = 2.50 fps, Avg. Travel Time= 1.2 min

Peak Storage= 125 cf @ 0.14 hrs
Average Depth at Peak Storage= 0.63' , Surface Width= 1.48'
Bank-Full Depth= 1.50' Flow Area= 1.8 sf, Capacity= 11.95 cfs

18.0" Round Pipe
n= 0.013 Corrugated PE, smooth interior
Length= 177.0' Slope= 0.0129 '/'
Inlet Invert= 406.85', Outlet Invert= 404.56'

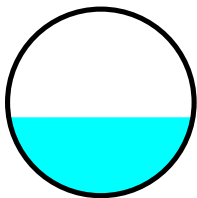

Reach P-A2: Pipe A2

Hydrograph

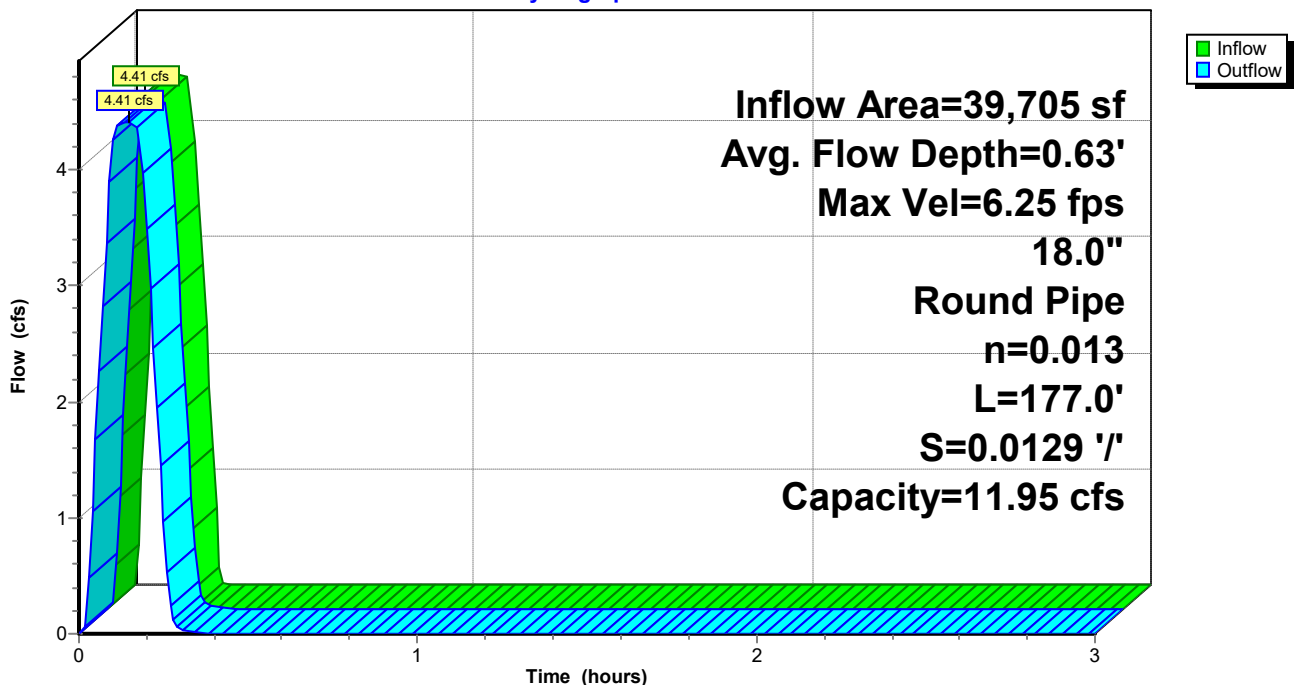

Reach P-A2: Pipe A2

Stage-Discharge

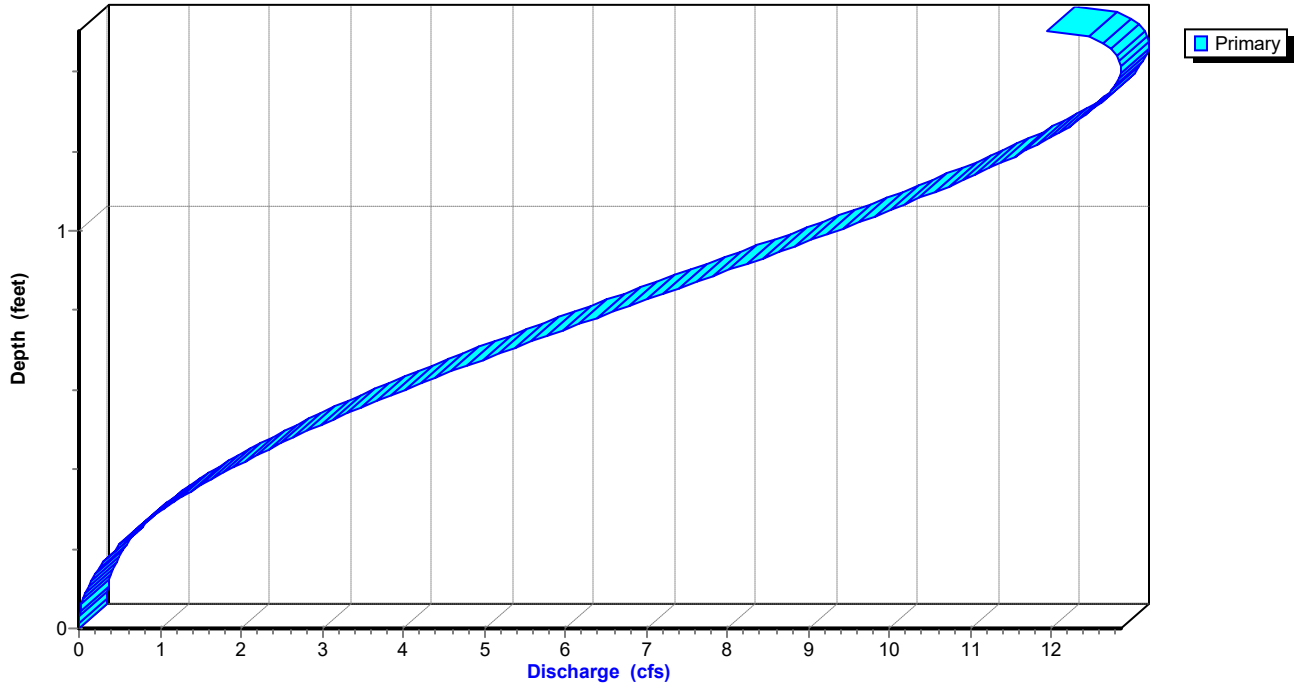

Summerwood Gym 3

Prepared by Phillip Lewis Engineering

HydroCAD® 10.20-2f s/n 12520 © 2022 HydroCAD Software Solutions LLC

AR - Little Rock 10-yr Duration=10 min, Inten=5.83 in/hr

Printed 1/11/2024

Stage-Area-Storage for Reach P-A2: Pipe A2

Elevation (feet)	End-Area (sq-ft)	Storage (cubic-feet)	Elevation (feet)	End-Area (sq-ft)	Storage (cubic-feet)
406.85	0.0	0	407.89	1.3	231
406.87	0.0	1	407.91	1.3	236
406.89	0.0	2	407.93	1.4	241
406.91	0.0	4	407.95	1.4	246
406.93	0.0	6	407.97	1.4	250
406.95	0.1	9	407.99	1.4	255
406.97	0.1	12	408.01	1.5	260
406.99	0.1	15	408.03	1.5	264
407.01	0.1	18	408.05	1.5	268
407.03	0.1	21	408.07	1.5	272
407.05	0.1	25	408.09	1.6	277
407.07	0.2	28	408.11	1.6	280
407.09	0.2	32	408.13	1.6	284
407.11	0.2	36	408.15	1.6	288
407.13	0.2	40	408.17	1.6	292
407.15	0.3	45	408.19	1.7	295
407.17	0.3	49	408.21	1.7	298
407.19	0.3	53	408.23	1.7	301
407.21	0.3	58	408.25	1.7	304
407.23	0.4	62	408.27	1.7	306
407.25	0.4	67	408.29	1.7	309
407.27	0.4	72	408.31	1.8	310
407.29	0.4	76	408.33	1.8	312
407.31	0.5	81	408.35	1.8	313
407.33	0.5	86			
407.35	0.5	91			
407.37	0.5	96			
407.39	0.6	101			
407.41	0.6	106			
407.43	0.6	112			
407.45	0.7	117			
407.47	0.7	122			
407.49	0.7	127			
407.51	0.7	133			
407.53	0.8	138			
407.55	0.8	143			
407.57	0.8	148			
407.59	0.9	154			
407.61	0.9	159			
407.63	0.9	164			
407.65	1.0	170			
407.67	1.0	175			
407.69	1.0	180			
407.71	1.0	185			
407.73	1.1	191			
407.75	1.1	196			
407.77	1.1	201			
407.79	1.2	206			
407.81	1.2	211			
407.83	1.2	216			
407.85	1.3	222			
407.87	1.3	226			

Summerwood Gym 3

Prepared by Phillip Lewis Engineering

HydroCAD® 10.20-2f s/n 12520 © 2022 HydroCAD Software Solutions LLC

AR - Little Rock 10-yr Duration=10 min, Inten=5.83 in/hr

Printed 1/11/2024

Summary for Reach P-A3: Pipe A3

Inflow Area = 71,768 sf, 58.28% Impervious, Inflow Depth = 0.71" for 10-yr event
Inflow = 7.00 cfs @ 0.17 hrs, Volume= 4,225 cf
Outflow = 6.96 cfs @ 0.17 hrs, Volume= 4,225 cf, Atten= 1%, Lag= 0.3 min
Routed to Reach P-A4 : Pipe A4

Routing by Stor-Ind+Trans method, Time Span= 0.00-3.00 hrs, dt= 0.01 hrs
Max. Velocity= 9.40 fps, Min. Travel Time= 0.2 min
Avg. Velocity = 3.90 fps, Avg. Travel Time= 0.5 min

Peak Storage= 88 cf @ 0.17 hrs
Average Depth at Peak Storage= 0.66' , Surface Width= 1.49'
Bank-Full Depth= 1.50' Flow Area= 1.8 sf, Capacity= 17.65 cfs

18.0" Round Pipe
n= 0.013 Corrugated PE, smooth interior
Length= 118.0' Slope= 0.0282 '/'
Inlet Invert= 404.46', Outlet Invert= 401.13'

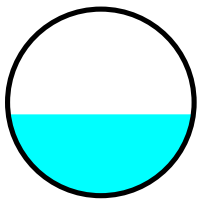

Reach P-A3: Pipe A3

Hydrograph

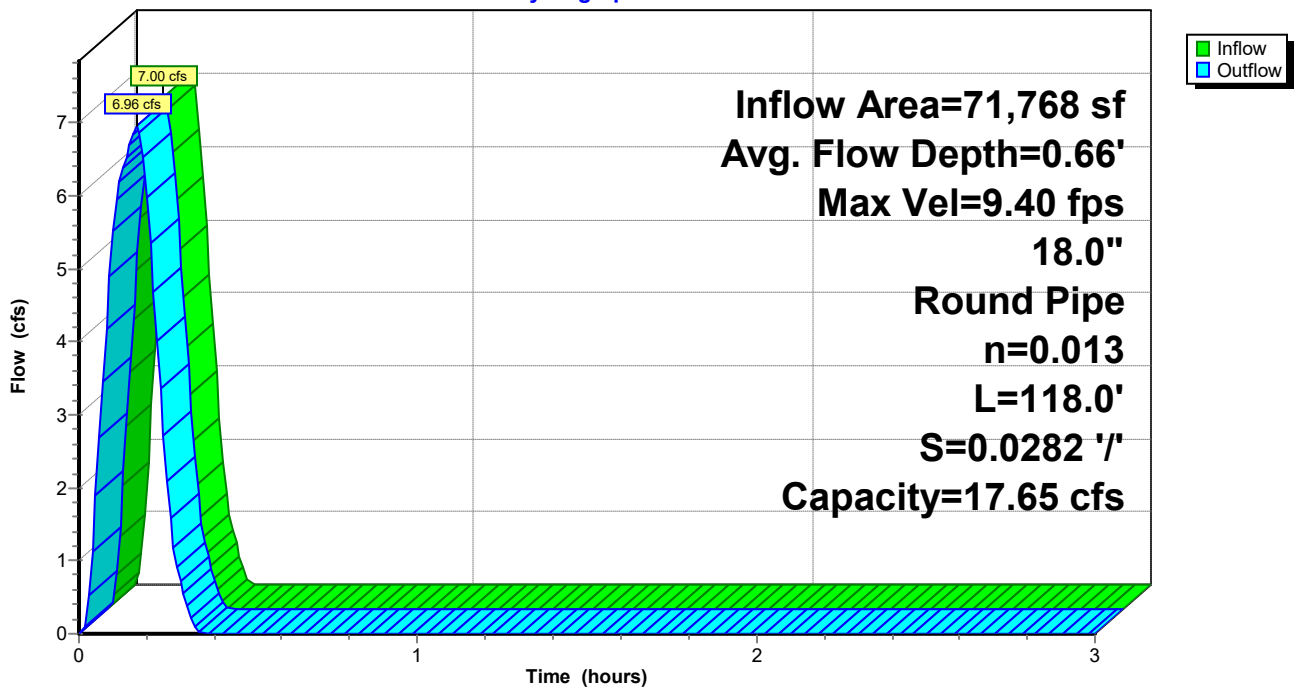

Reach P-A3: Pipe A3

Stage-Discharge

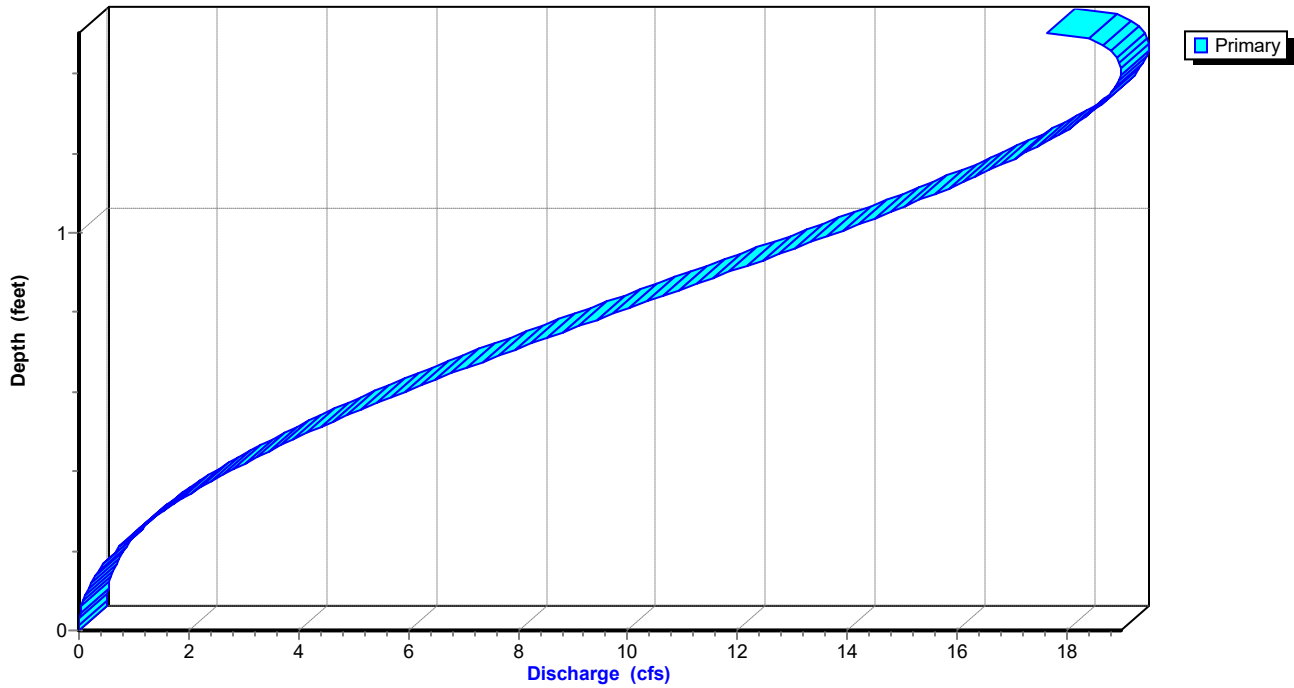

Summerwood Gym 3*AR - Little Rock 10-yr Duration=10 min, Inten=5.83 in/hr*

Prepared by Phillip Lewis Engineering

Printed 1/11/2024

HydroCAD® 10.20-2f s/n 12520 © 2022 HydroCAD Software Solutions LLC

Stage-Area-Storage for Reach P-A3: Pipe A3

Elevation (feet)	End-Area (sq-ft)	Storage (cubic-feet)	Elevation (feet)	End-Area (sq-ft)	Storage (cubic-feet)
404.46	0.0	0	405.50	1.3	154
404.48	0.0	1	405.52	1.3	158
404.50	0.0	2	405.54	1.4	161
404.52	0.0	3	405.56	1.4	164
404.54	0.0	4	405.58	1.4	167
404.56	0.1	6	405.60	1.4	170
404.58	0.1	8	405.62	1.5	173
404.60	0.1	10	405.64	1.5	176
404.62	0.1	12	405.66	1.5	179
404.64	0.1	14	405.68	1.5	182
404.66	0.1	17	405.70	1.6	184
404.68	0.2	19	405.72	1.6	187
404.70	0.2	22	405.74	1.6	190
404.72	0.2	24	405.76	1.6	192
404.74	0.2	27	405.78	1.6	194
404.76	0.3	30	405.80	1.7	197
404.78	0.3	33	405.82	1.7	199
404.80	0.3	35	405.84	1.7	201
404.82	0.3	38	405.86	1.7	203
404.84	0.4	42	405.88	1.7	204
404.86	0.4	45	405.90	1.7	206
404.88	0.4	48	405.92	1.8	207
404.90	0.4	51	405.94	1.8	208
404.92	0.5	54	405.96	1.8	209
404.94	0.5	58			
404.96	0.5	61			
404.98	0.5	64			
405.00	0.6	68			
405.02	0.6	71			
405.04	0.6	74			
405.06	0.7	78			
405.08	0.7	81			
405.10	0.7	85			
405.12	0.7	88			
405.14	0.8	92			
405.16	0.8	95			
405.18	0.8	99			
405.20	0.9	102			
405.22	0.9	106			
405.24	0.9	110			
405.26	1.0	113			
405.28	1.0	117			
405.30	1.0	120			
405.32	1.0	124			
405.34	1.1	127			
405.36	1.1	131			
405.38	1.1	134			
405.40	1.2	138			
405.42	1.2	141			
405.44	1.2	144			
405.46	1.3	148			
405.48	1.3	151			

Summerwood Gym 3

Prepared by Phillip Lewis Engineering

HydroCAD® 10.20-2f s/n 12520 © 2022 HydroCAD Software Solutions LLC

AR - Little Rock 10-yr Duration=10 min, Inten=5.83 in/hr

Printed 1/11/2024

Summary for Reach P-A4: Pipe A4

Inflow Area = 71,768 sf, 58.28% Impervious, Inflow Depth = 0.71" for 10-yr event
Inflow = 6.96 cfs @ 0.17 hrs, Volume= 4,225 cf
Outflow = 6.93 cfs @ 0.18 hrs, Volume= 4,225 cf, Atten= 0%, Lag= 0.4 min
Routed to Pond DP1 : Re-Established East Pond

Routing by Stor-Ind+Trans method, Time Span= 0.00-3.00 hrs, dt= 0.01 hrs
Max. Velocity= 9.39 fps, Min. Travel Time= 0.2 min
Avg. Velocity = 3.71 fps, Avg. Travel Time= 0.6 min

Peak Storage= 98 cf @ 0.17 hrs
Average Depth at Peak Storage= 0.65' , Surface Width= 1.49'
Bank-Full Depth= 1.50' Flow Area= 1.8 sf, Capacity= 17.66 cfs

18.0" Round Pipe
n= 0.013 Corrugated PE, smooth interior
Length= 132.0' Slope= 0.0283 '/'
Inlet Invert= 401.03', Outlet Invert= 397.30'

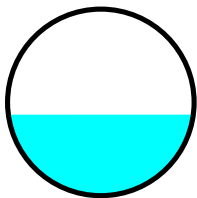

Reach P-A4: Pipe A4

Hydrograph

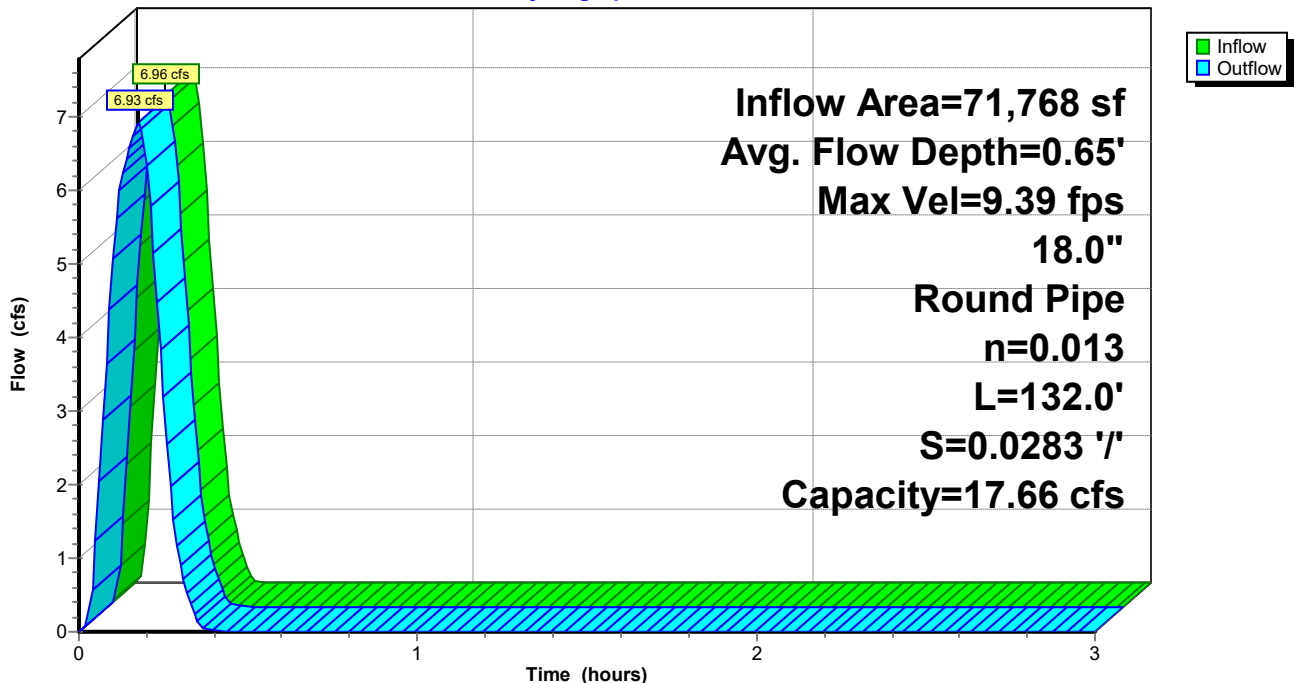

Reach P-A4: Pipe A4

Stage-Discharge

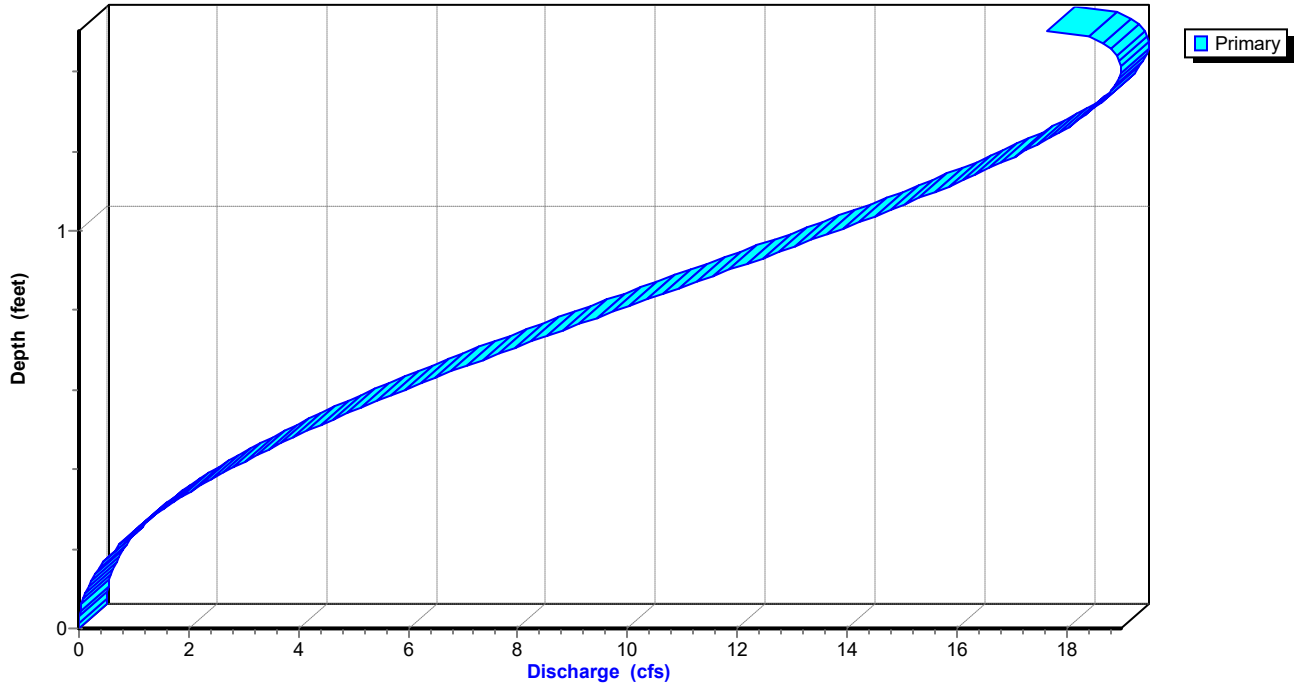

Summerwood Gym 3*AR - Little Rock 10-yr Duration=10 min, Inten=5.83 in/hr*

Prepared by Phillip Lewis Engineering

Printed 1/11/2024

HydroCAD® 10.20-2f s/n 12520 © 2022 HydroCAD Software Solutions LLC

Stage-Area-Storage for Reach P-A4: Pipe A4

Elevation (feet)	End-Area (sq-ft)	Storage (cubic-feet)	Elevation (feet)	End-Area (sq-ft)	Storage (cubic-feet)
401.03	0.0	0	402.07	1.3	173
401.05	0.0	1	402.09	1.3	176
401.07	0.0	2	402.11	1.4	180
401.09	0.0	3	402.13	1.4	183
401.11	0.0	5	402.15	1.4	187
401.13	0.1	7	402.17	1.4	190
401.15	0.1	9	402.19	1.5	194
401.17	0.1	11	402.21	1.5	197
401.19	0.1	13	402.23	1.5	200
401.21	0.1	16	402.25	1.5	203
401.23	0.1	18	402.27	1.6	206
401.25	0.2	21	402.29	1.6	209
401.27	0.2	24	402.31	1.6	212
401.29	0.2	27	402.33	1.6	215
401.31	0.2	30	402.35	1.6	217
401.33	0.3	33	402.37	1.7	220
401.35	0.3	36	402.39	1.7	222
401.37	0.3	40	402.41	1.7	225
401.39	0.3	43	402.43	1.7	227
401.41	0.4	46	402.45	1.7	228
401.43	0.4	50	402.47	1.7	230
401.45	0.4	53	402.49	1.8	232
401.47	0.4	57	402.51	1.8	233
401.49	0.5	61	402.53	1.8	233
401.51	0.5	64			
401.53	0.5	68			
401.55	0.5	72			
401.57	0.6	76			
401.59	0.6	79			
401.61	0.6	83			
401.63	0.7	87			
401.65	0.7	91			
401.67	0.7	95			
401.69	0.7	99			
401.71	0.8	103			
401.73	0.8	107			
401.75	0.8	111			
401.77	0.9	115			
401.79	0.9	119			
401.81	0.9	123			
401.83	1.0	127			
401.85	1.0	130			
401.87	1.0	134			
401.89	1.0	138			
401.91	1.1	142			
401.93	1.1	146			
401.95	1.1	150			
401.97	1.2	154			
401.99	1.2	158			
402.01	1.2	161			
402.03	1.3	165			
402.05	1.3	169			

Summerwood Gym 3

AR - Little Rock 10-yr Duration=10 min, Inten=5.83 in/hr

Prepared by Phillip Lewis Engineering

Printed 1/11/2024

HydroCAD® 10.20-2f s/n 12520 © 2022 HydroCAD Software Solutions LLC

Summary for Pond DP1: Re-Established East Pond

Inflow Area = 132,514 sf, 61.41% Impervious, Inflow Depth = 0.72" for 10-yr event
Inflow = 12.95 cfs @ 0.16 hrs, Volume= 7,945 cf
Outflow = 7.07 cfs @ 0.22 hrs, Volume= 7,945 cf, Atten= 45%, Lag= 3.7 min
Primary = 7.07 cfs @ 0.22 hrs, Volume= 7,945 cf
Routed to Link Post-Dev : APPROX DISCHARGE

Routing by Stor-Ind method, Time Span= 0.00-3.00 hrs, dt= 0.01 hrs
Peak Elev= 398.14' @ 0.22 hrs Storage= 4,074 cf

Plug-Flow detention time= 8.2 min calculated for 7,919 cf (100% of inflow)
Center-of-Mass det. time= 8.3 min (17.2 - 8.9)

Volume	Invert	Avail.Storage	Storage Description
#1	396.00'	8,557 cf	Custom Stage Data Listed below

Elevation (feet)	Inc.Store (cubic-feet)	Cum.Store (cubic-feet)
396.00	0	0
396.50	250	250
397.00	1,092	1,342
398.00	2,387	3,729
399.00	2,405	6,134
400.00	2,423	8,557

Device	Routing	Invert	Outlet Devices
#1	Primary	399.00'	5.0' long Sharp-Crested Rectangular Weir 2 End Contraction(s)
#2	Primary	396.00'	1.1' long Sharp-Crested Rectangular Weir 2 End Contraction(s) 10.0' Crest Height

Primary OutFlow Max=7.06 cfs @ 0.22 hrs HW=398.14' (Free Discharge)

└─1=Sharp-Crested Rectangular Weir (Controls 0.00 cfs)

└─2=Sharp-Crested Rectangular Weir (Weir Controls 7.06 cfs @ 4.91 fps)

Summerwood Gym 3

Prepared by Phillip Lewis Engineering

HydroCAD® 10.20-2f s/n 12520 © 2022 HydroCAD Software Solutions LLC

AR - Little Rock 10-yr Duration=10 min, Inten=5.83 in/hr

Printed 1/11/2024

Pond DP1: Re-Established East Pond

Hydrograph

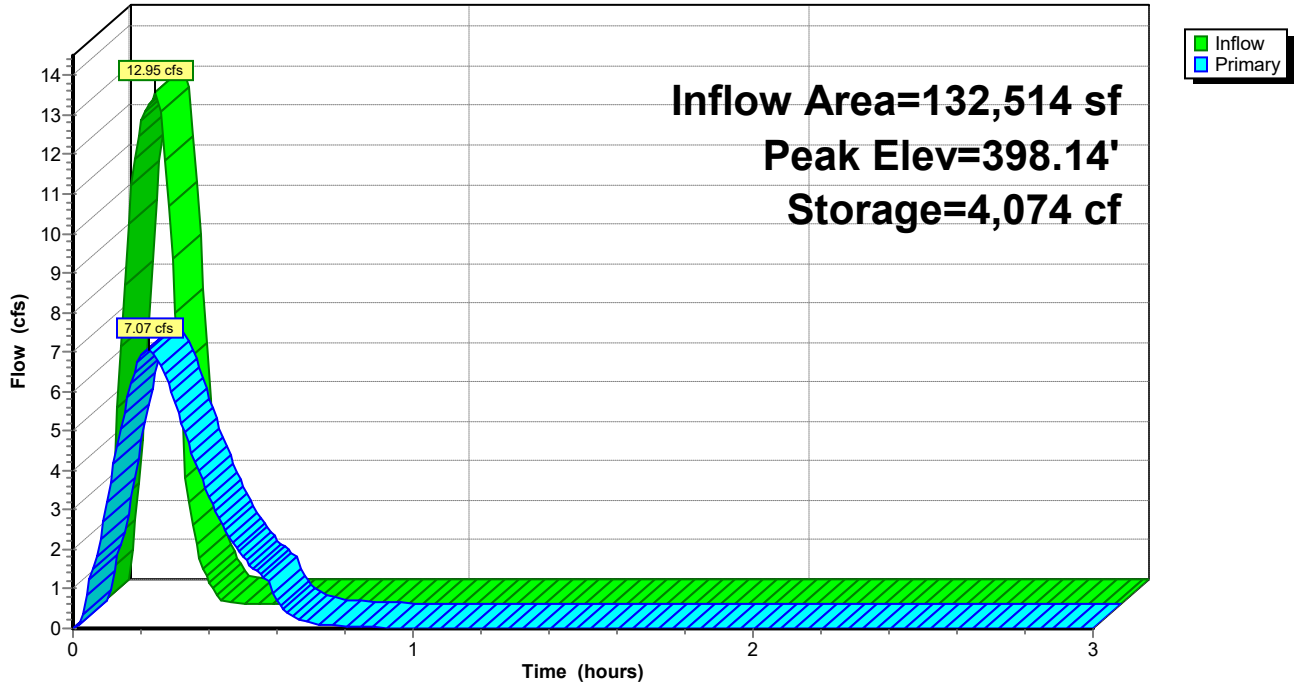

Pond DP1: Re-Established East Pond

Stage-Discharge

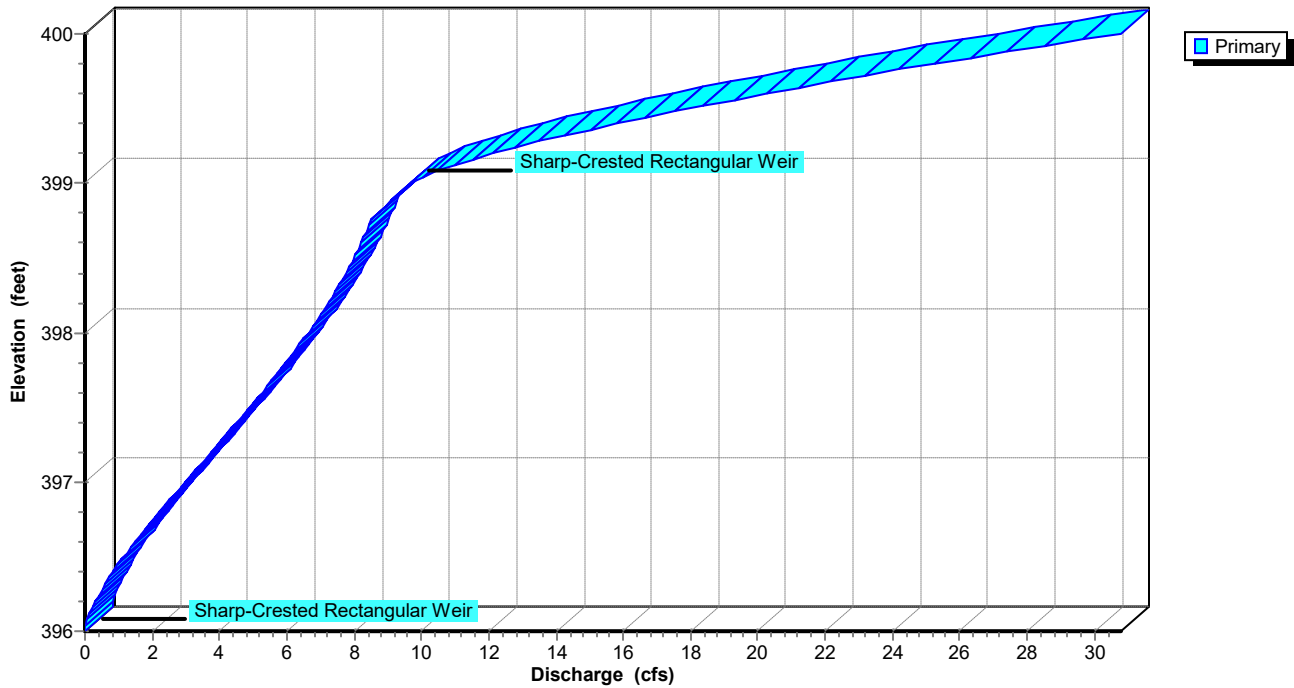

Summerwood Gym 3

Prepared by Phillip Lewis Engineering

HydroCAD® 10.20-2f s/n 12520 © 2022 HydroCAD Software Solutions LLC

AR - Little Rock 10-yr Duration=10 min, Inten=5.83 in/hr

Printed 1/11/2024

Stage-Area-Storage for Pond DP1: Re-Established East Pond

Elevation (feet)	Storage (cubic-feet)	Elevation (feet)	Storage (cubic-feet)
396.00	0	398.60	5,172
396.05	25	398.65	5,292
396.10	50	398.70	5,412
396.15	75	398.75	5,533
396.20	100	398.80	5,653
396.25	125	398.85	5,773
396.30	150	398.90	5,893
396.35	175	398.95	6,014
396.40	200	399.00	6,134
396.45	225	399.05	6,255
396.50	250	399.10	6,376
396.55	359	399.15	6,497
396.60	468	399.20	6,619
396.65	578	399.25	6,740
396.70	687	399.30	6,861
396.75	796	399.35	6,982
396.80	905	399.40	7,103
396.85	1,014	399.45	7,224
396.90	1,124	399.50	7,346
396.95	1,233	399.55	7,467
397.00	1,342	399.60	7,588
397.05	1,461	399.65	7,709
397.10	1,581	399.70	7,830
397.15	1,700	399.75	7,951
397.20	1,819	399.80	8,072
397.25	1,939	399.85	8,194
397.30	2,058	399.90	8,315
397.35	2,177	399.95	8,436
397.40	2,297	400.00	8,557
397.45	2,416		
397.50	2,536		
397.55	2,655		
397.60	2,774		
397.65	2,894		
397.70	3,013		
397.75	3,132		
397.80	3,252		
397.85	3,371		
397.90	3,490		
397.95	3,610		
398.00	3,729		
398.05	3,849		
398.10	3,970		
398.15	4,090		
398.20	4,210		
398.25	4,330		
398.30	4,451		
398.35	4,571		
398.40	4,691		
398.45	4,811		
398.50	4,932		
398.55	5,052		

Summerwood Gym 3

Prepared by Phillip Lewis Engineering

HydroCAD® 10.20-2f s/n 12520 © 2022 HydroCAD Software Solutions LLC

AR - Little Rock 10-yr Duration=10 min, Inten=5.83 in/hr

Printed 1/11/2024

Summary for Link Post-Dev: APPROX DISCHARGE

Inflow Area = 206,166 sf, 64.42% Impervious, Inflow Depth = 0.73" for 10-yr event
Inflow = 13.74 cfs @ 0.17 hrs, Volume= 12,613 cf
Primary = 13.74 cfs @ 0.17 hrs, Volume= 12,613 cf, Atten= 0%, Lag= 0.0 min

Primary outflow = Inflow, Time Span= 0.00-3.00 hrs, dt= 0.01 hrs

Link Post-Dev: APPROX DISCHARGE

Hydrograph

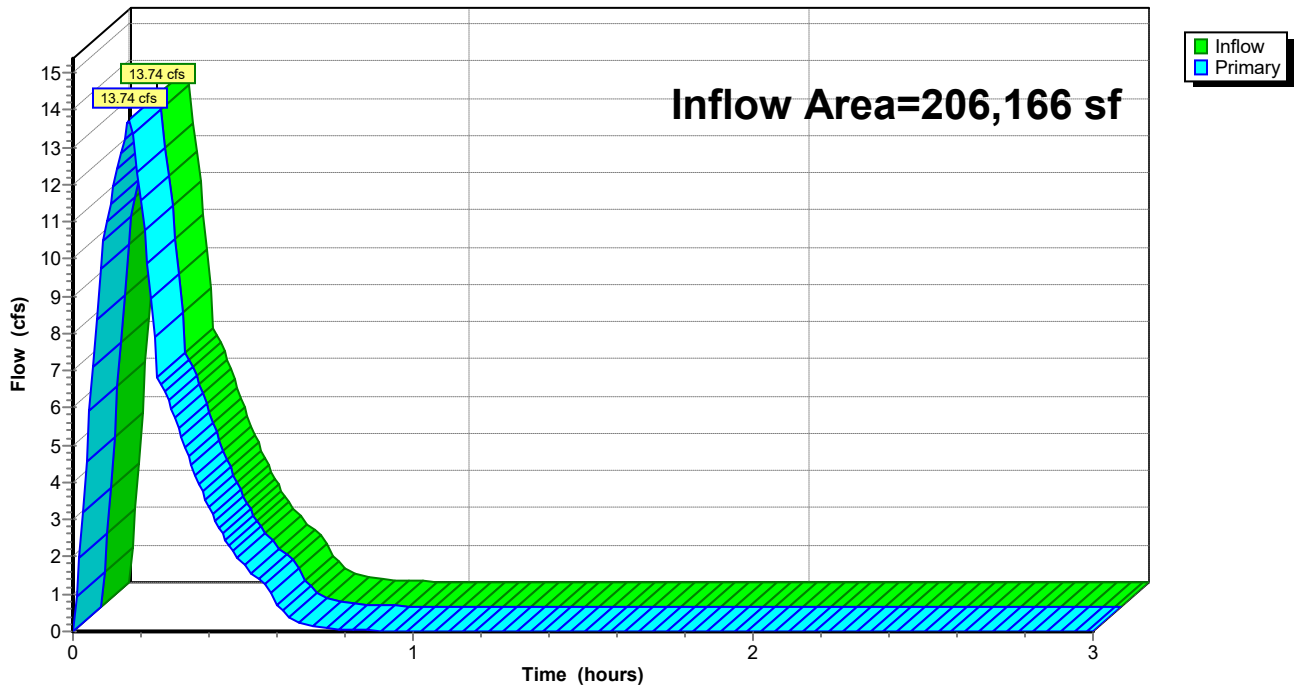

Summerwood Gym 3

Prepared by Phillip Lewis Engineering

HydroCAD® 10.20-2f s/n 12520 © 2022 HydroCAD Software Solutions LLC

AR - Little Rock 25-yr Duration=10 min, Inten=6.72 in/hr

Printed 1/11/2024

Summary for Subcatchment D1: Drainage Basin D1

Runoff = 6.89 cfs @ 0.09 hrs, Volume= 4,126 cf, Depth= 1.02"
 Routed to Link Post-Dev : APPROX DISCHARGE

Runoff by Rational method, Rise/Fall=1.0/1.0 xTc, Time Span= 0.00-3.00 hrs, dt= 0.01 hrs
 AR - Little Rock 25-yr Duration=10 min, Inten=6.72 in/hr

Area (sf)	C	Description
3,421	0.40	Sod Yard
45,236	0.95	Road, Drives, Sidewalks
48,657	0.91	Weighted Average
3,421		7.03% Pervious Area
45,236		92.97% Impervious Area

Tc (min)	Length (feet)	Slope (ft/ft)	Velocity (ft/sec)	Capacity (cfs)	Description
5.0					Direct Entry, Overland Concentrated Flow (Min)

Subcatchment D1: Drainage Basin D1

Hydrograph

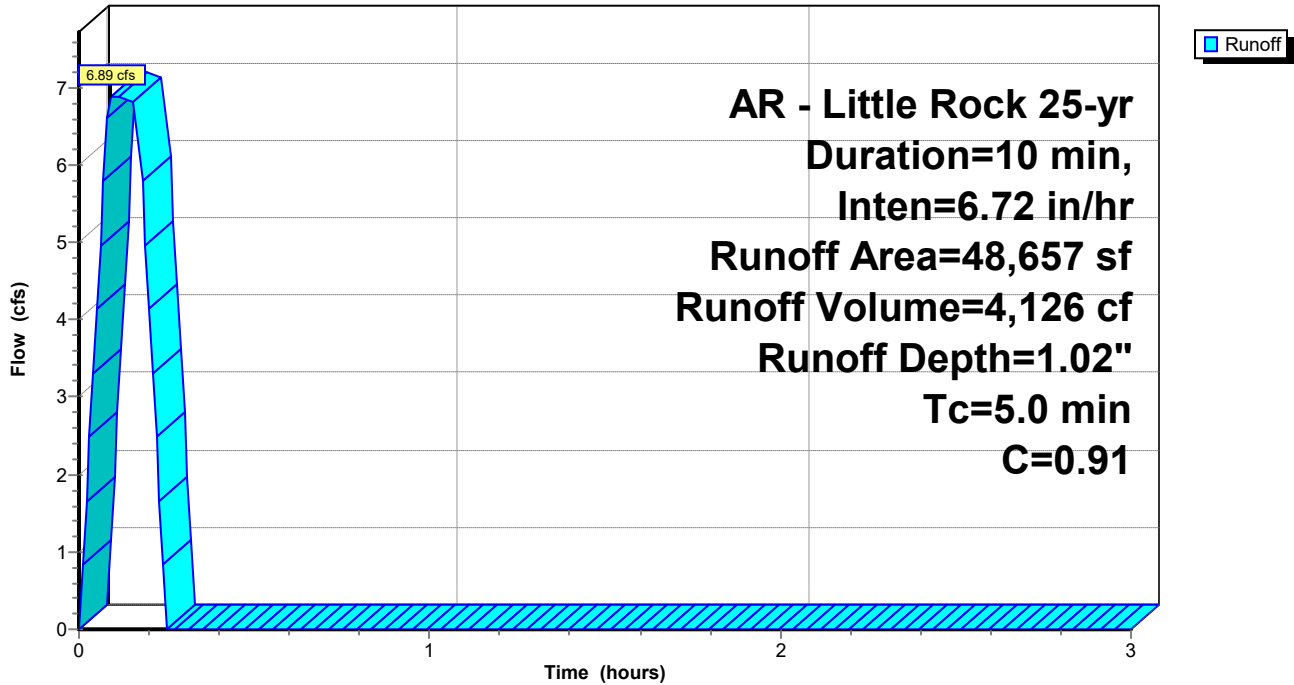

Summerwood Gym 3

Prepared by Phillip Lewis Engineering

HydroCAD® 10.20-2f s/n 12520 © 2022 HydroCAD Software Solutions LLC

AR - Little Rock 25-yr Duration=10 min, Inten=6.72 in/hr

Printed 1/11/2024

Summary for Subcatchment D2: Drainage Basin D2

Runoff = 2.92 cfs @ 0.09 hrs, Volume= 1,752 cf, Depth= 0.86"

Routed to Reach P-A1 : Pipe A1

Runoff by Rational method, Rise/Fall=1.0/1.0 xTc, Time Span= 0.00-3.00 hrs, dt= 0.01 hrs

AR - Little Rock 25-yr Duration=10 min, Inten=6.72 in/hr

Area (sf)	C	Description
8,845	0.45	Rip Rap Embankment
15,566	0.95	Roof, Drives, Sidewalks
24,411	0.77	Weighted Average
8,845		36.23% Pervious Area
15,566		63.77% Impervious Area

Tc (min)	Length (feet)	Slope (ft/ft)	Velocity (ft/sec)	Capacity (cfs)	Description
5.0	415		1.38		Direct Entry, Overland Concentrated Flow (Min)

Subcatchment D2: Drainage Basin D2

Hydrograph

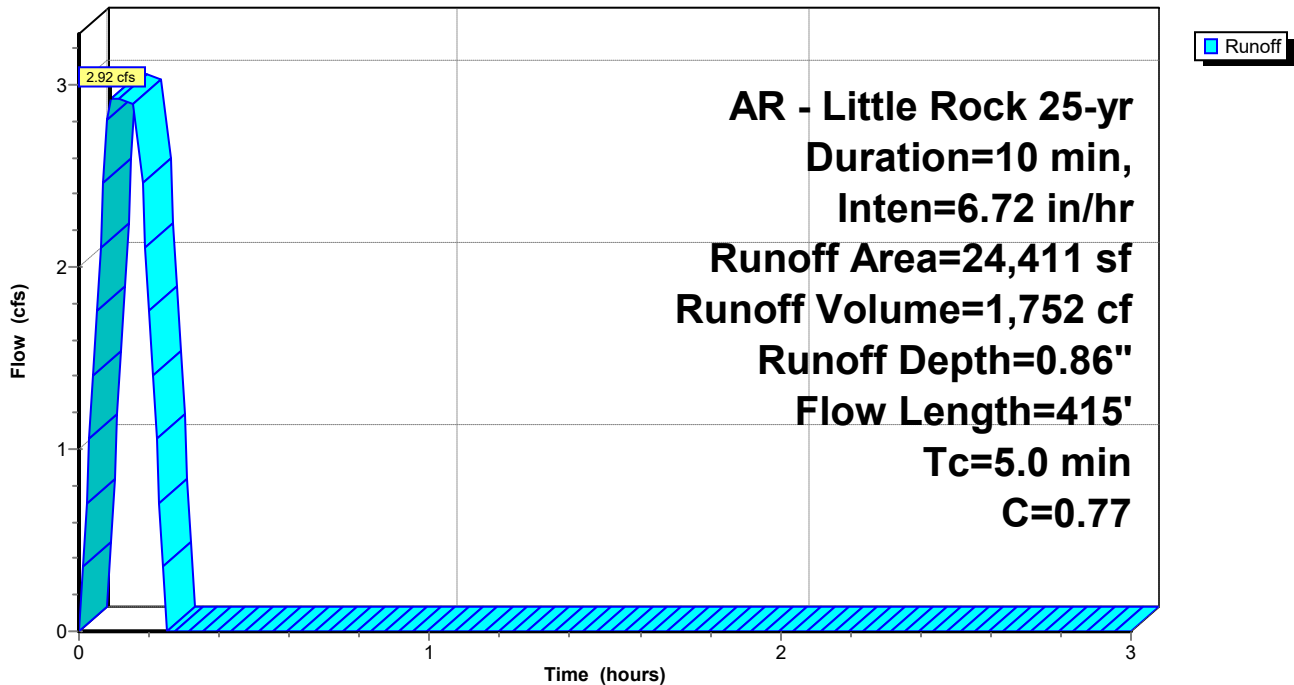

Summerwood Gym 3

Prepared by Phillip Lewis Engineering

HydroCAD® 10.20-2f s/n 12520 © 2022 HydroCAD Software Solutions LLC

AR - Little Rock 25-yr Duration=10 min, Inten=6.72 in/hr

Printed 1/11/2024

Summary for Subcatchment D3: Drainage Basin D3

Runoff = 2.16 cfs @ 0.09 hrs, Volume= 1,297 cf, Depth= 1.02"

Routed to Reach P-A2 : Pipe A2

Runoff by Rational method, Rise/Fall=1.0/1.0 xTc, Time Span= 0.00-3.00 hrs, dt= 0.01 hrs

AR - Little Rock 25-yr Duration=10 min, Inten=6.72 in/hr

Area (sf)	C	Description
1,065	0.40	Sod Yard
14,229	0.95	Paving, Sidewalks
15,294	0.91	Weighted Average
1,065		6.96% Pervious Area
14,229		93.04% Impervious Area

Tc (min)	Length (feet)	Slope (ft/ft)	Velocity (ft/sec)	Capacity (cfs)	Description
5.0	415		1.38		Direct Entry, Overland Concentrated Flow (Min)

Subcatchment D3: Drainage Basin D3

Hydrograph

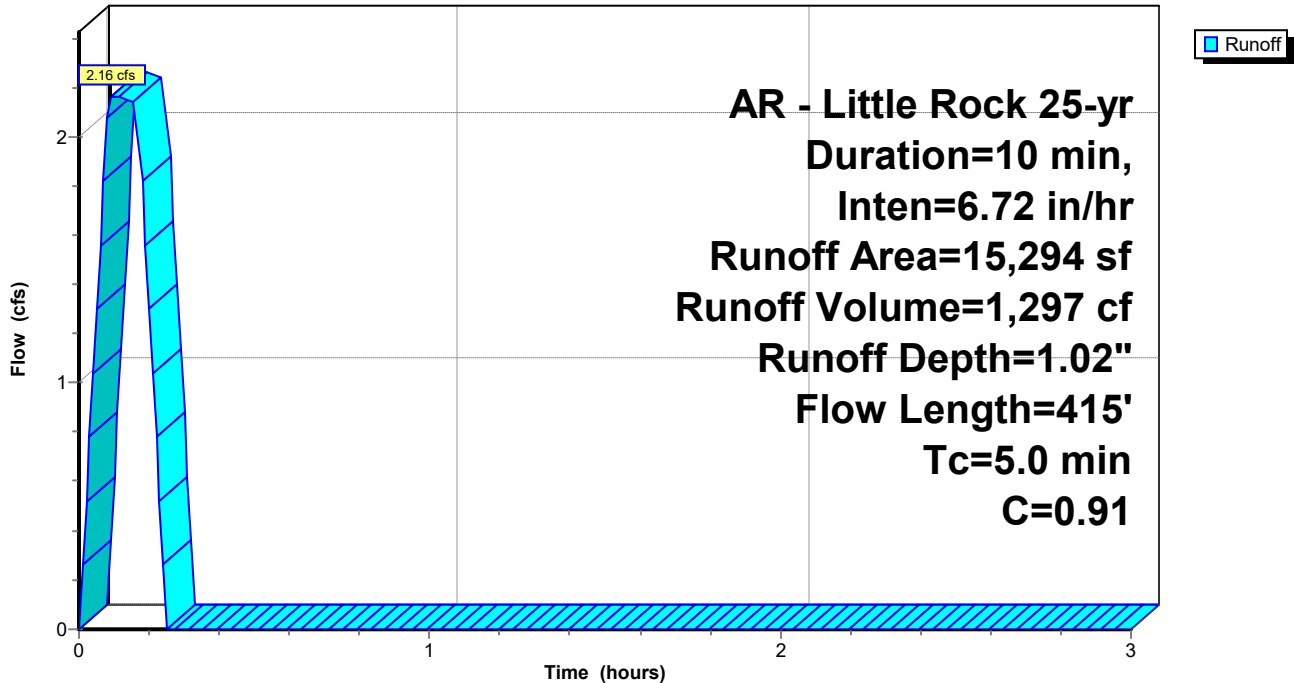

Summerwood Gym 3

Prepared by Phillip Lewis Engineering

HydroCAD® 10.20-2f s/n 12520 © 2022 HydroCAD Software Solutions LLC

AR - Little Rock 25-yr Duration=10 min, Inten=6.72 in/hr

Printed 1/11/2024

Summary for Subcatchment D4: Drainage Basin D4

Runoff = 2.99 cfs @ 0.17 hrs, Volume= 1,825 cf, Depth= 0.68"

Routed to Reach P-A3 : Pipe A3

Runoff by Rational method, Rise/Fall=1.0/1.0 xTc, Time Span= 0.00-3.00 hrs, dt= 0.01 hrs

AR - Little Rock 25-yr Duration=10 min, Inten=6.72 in/hr

Area (sf)	C	Description
20,032	0.40	
12,031	0.95	
32,063	0.61	Weighted Average
20,032		62.48% Pervious Area
12,031		37.52% Impervious Area

Tc (min)	Length (feet)	Slope (ft/ft)	Velocity (ft/sec)	Capacity (cfs)	Description
10.0	415		0.69		Direct Entry, Overland Concentrated Flow (Min)

Subcatchment D4: Drainage Basin D4

Hydrograph

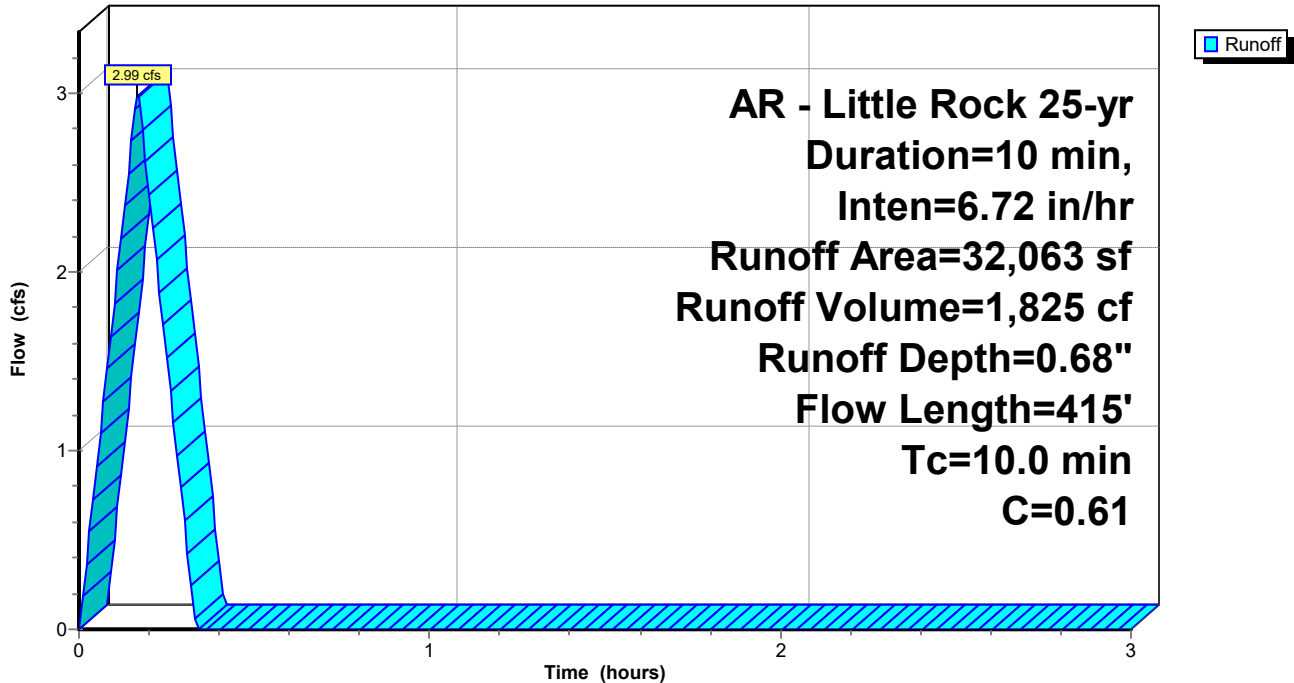

Summerwood Gym 3

Prepared by Phillip Lewis Engineering

HydroCAD® 10.20-2f s/n 12520 © 2022 HydroCAD Software Solutions LLC

AR - Little Rock 25-yr Duration=10 min, Inten=6.72 in/hr

Printed 1/11/2024

Summary for Subcatchment D5: Drainage Basin D5

Runoff = 4.34 cfs @ 0.09 hrs, Volume= 2,600 cf, Depth= 0.75"
 Routed to Pond DP1 : Re-Established East Pond

Runoff by Rational method, Rise/Fall=1.0/1.0 xTc, Time Span= 0.00-3.00 hrs, dt= 0.01 hrs
 AR - Little Rock 25-yr Duration=10 min, Inten=6.72 in/hr

Area (sf)	C	Description
21,201	0.40	Sod Yard, Natural Vegetation
20,437	0.95	Paving, Sidewalks
41,638	0.67	Weighted Average
21,201		50.92% Pervious Area
20,437		49.08% Impervious Area

Tc (min)	Length (feet)	Slope (ft/ft)	Velocity (ft/sec)	Capacity (cfs)	Description
5.0					Direct Entry, Overland Concentrated Flow (Min)

Subcatchment D5: Drainage Basin D5

Hydrograph

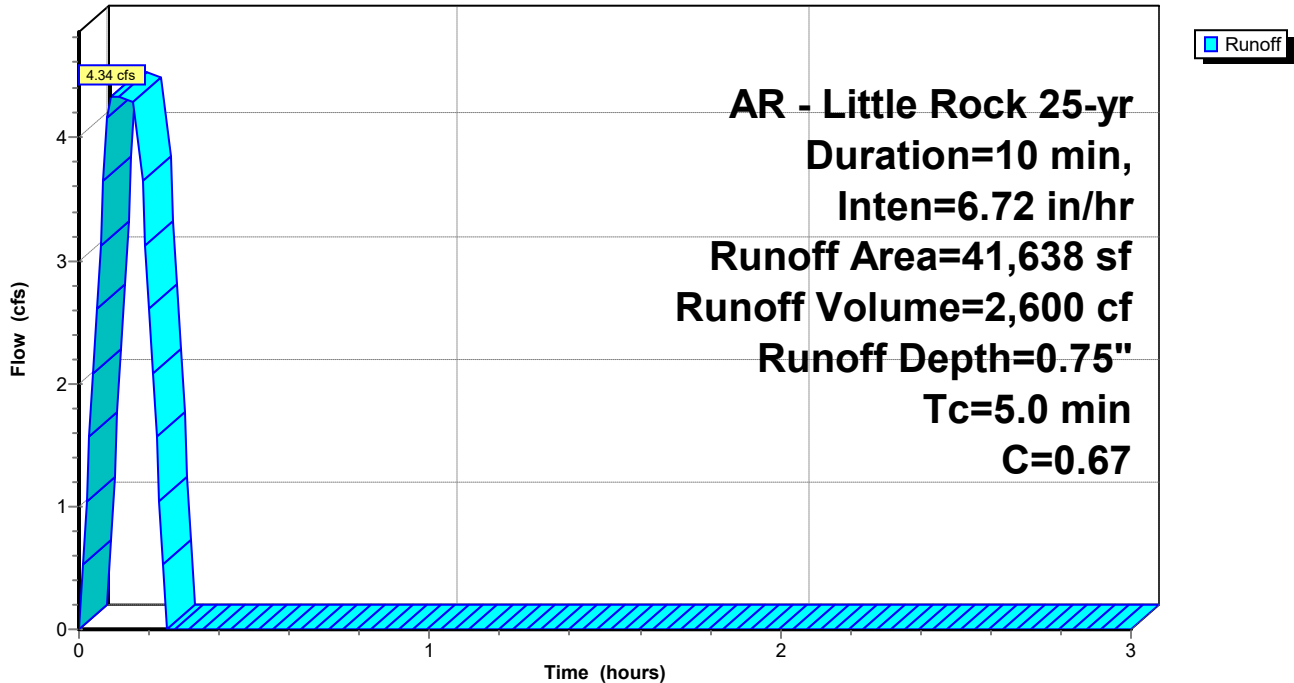

Summerwood Gym 3

Prepared by Phillip Lewis Engineering

HydroCAD® 10.20-2f s/n 12520 © 2022 HydroCAD Software Solutions LLC

AR - Little Rock 25-yr Duration=10 min, Inten=6.72 in/hr

Printed 1/11/2024

Summary for Subcatchment D6: Drainage Basin D6

Runoff = 2.82 cfs @ 0.09 hrs, Volume= 1,692 cf, Depth= 1.06"

Routed to Pond DP1 : Re-Established East Pond

Runoff by Rational method, Rise/Fall=1.0/1.0 xTc, Time Span= 0.00-3.00 hrs, dt= 0.01 hrs

AR - Little Rock 25-yr Duration=10 min, Inten=6.72 in/hr

Area (sf)	C	Description
19,108	0.95	Roof
19,108		100.00% Impervious Area

Tc (min)	Length (feet)	Slope (ft/ft)	Velocity (ft/sec)	Capacity (cfs)	Description
5.0					Direct Entry, Overland Concentrated Flow (Min)

Subcatchment D6: Drainage Basin D6

Hydrograph

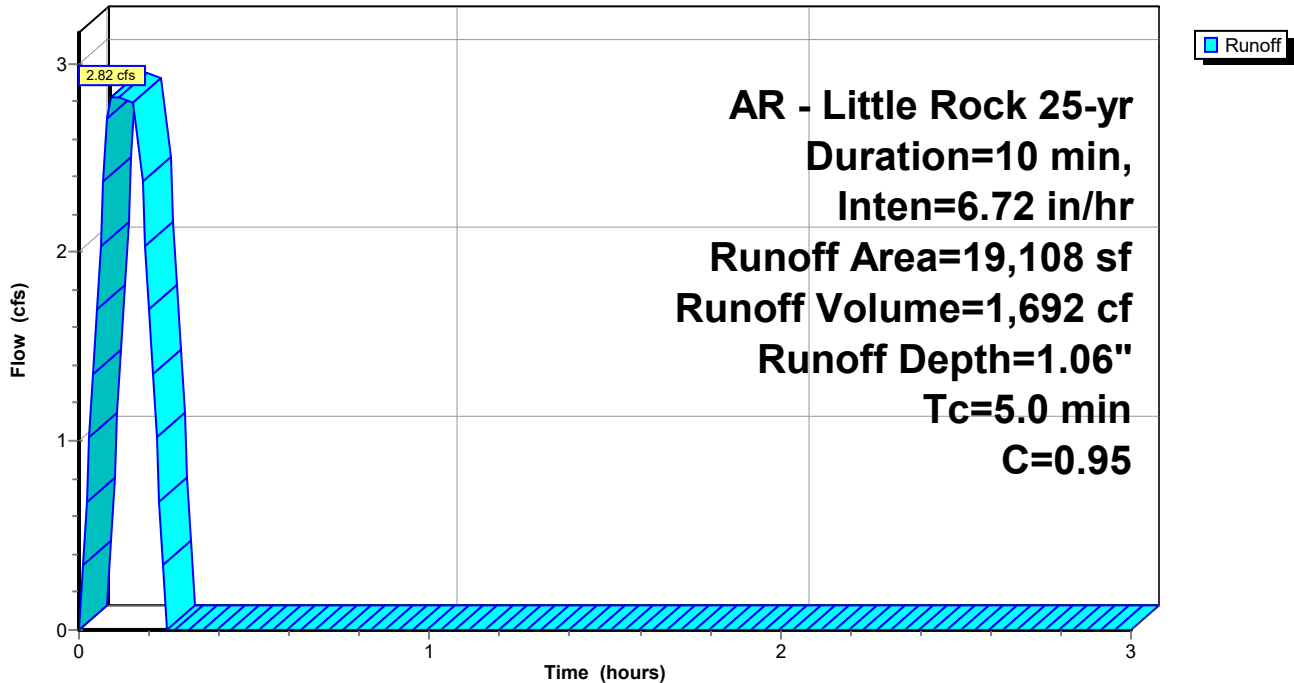

Summerwood Gym 3

Prepared by Phillip Lewis Engineering

HydroCAD® 10.20-2f s/n 12520 © 2022 HydroCAD Software Solutions LLC

AR - Little Rock 25-yr Duration=10 min, Inten=6.72 in/hr

Printed 1/11/2024

Summary for Subcatchment D7: Drainage Basin D7

Runoff = 2.10 cfs @ 0.09 hrs, Volume= 1,258 cf, Depth= 0.60"
 Routed to Link Post-Dev : APPROX DISCHARGE

Runoff by Rational method, Rise/Fall=1.0/1.0 xTc, Time Span= 0.00-3.00 hrs, dt= 0.01 hrs
 AR - Little Rock 25-yr Duration=10 min, Inten=6.72 in/hr

Area (sf)	C	Description
18,798	0.40	Sod Yard, Natural Vegetation
6,197	0.95	Paving, Sidewalks
24,995	0.54	Weighted Average
18,798		75.21% Pervious Area
6,197		24.79% Impervious Area

Tc (min)	Length (feet)	Slope (ft/ft)	Velocity (ft/sec)	Capacity (cfs)	Description
5.0					Direct Entry, Overland Concentrated Flow (Min)

Subcatchment D7: Drainage Basin D7

Hydrograph

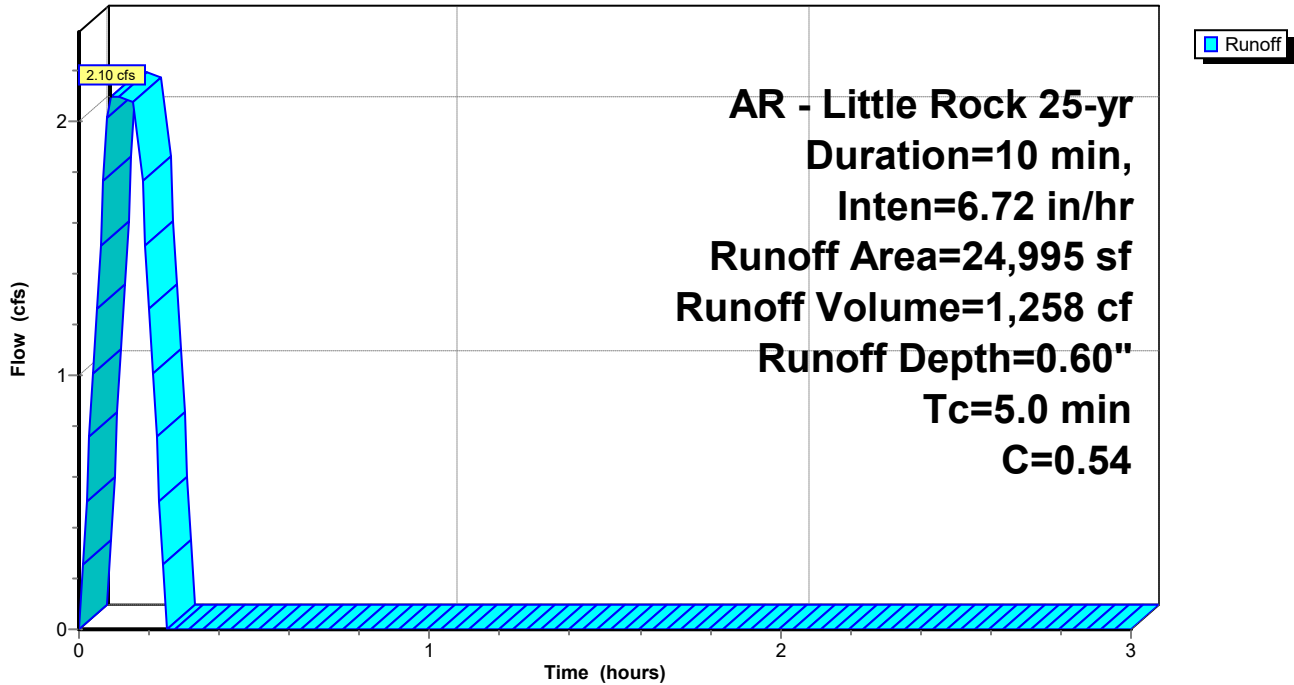

Summerwood Gym 3

Prepared by Phillip Lewis Engineering

HydroCAD® 10.20-2f s/n 12520 © 2022 HydroCAD Software Solutions LLC

AR - Little Rock 25-yr Duration=10 min, Inten=6.72 in/hr

Printed 1/11/2024

Summary for Reach P-A1: Pipe A1

Inflow Area = 24,411 sf, 63.77% Impervious, Inflow Depth = 0.86" for 25-yr event
Inflow = 2.92 cfs @ 0.09 hrs, Volume= 1,752 cf
Outflow = 2.92 cfs @ 0.11 hrs, Volume= 1,752 cf, Atten= 0%, Lag= 1.2 min
Routed to Reach P-A2 : Pipe A2

Routing by Stor-Ind+Trans method, Time Span= 0.00-3.00 hrs, dt= 0.01 hrs
Max. Velocity= 7.28 fps, Min. Travel Time= 0.1 min
Avg. Velocity = 5.29 fps, Avg. Travel Time= 0.2 min

Peak Storage= 20 cf @ 0.09 hrs
Average Depth at Peak Storage= 0.42' , Surface Width= 1.34'
Bank-Full Depth= 1.50' Flow Area= 1.8 sf, Capacity= 17.28 cfs

18.0" Round Pipe
n= 0.013 Corrugated PE, smooth interior
Length= 51.0' Slope= 0.0271 '/'
Inlet Invert= 408.33', Outlet Invert= 406.95'

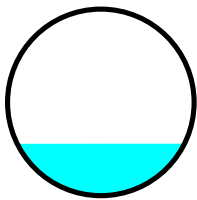

Reach P-A1: Pipe A1

Hydrograph

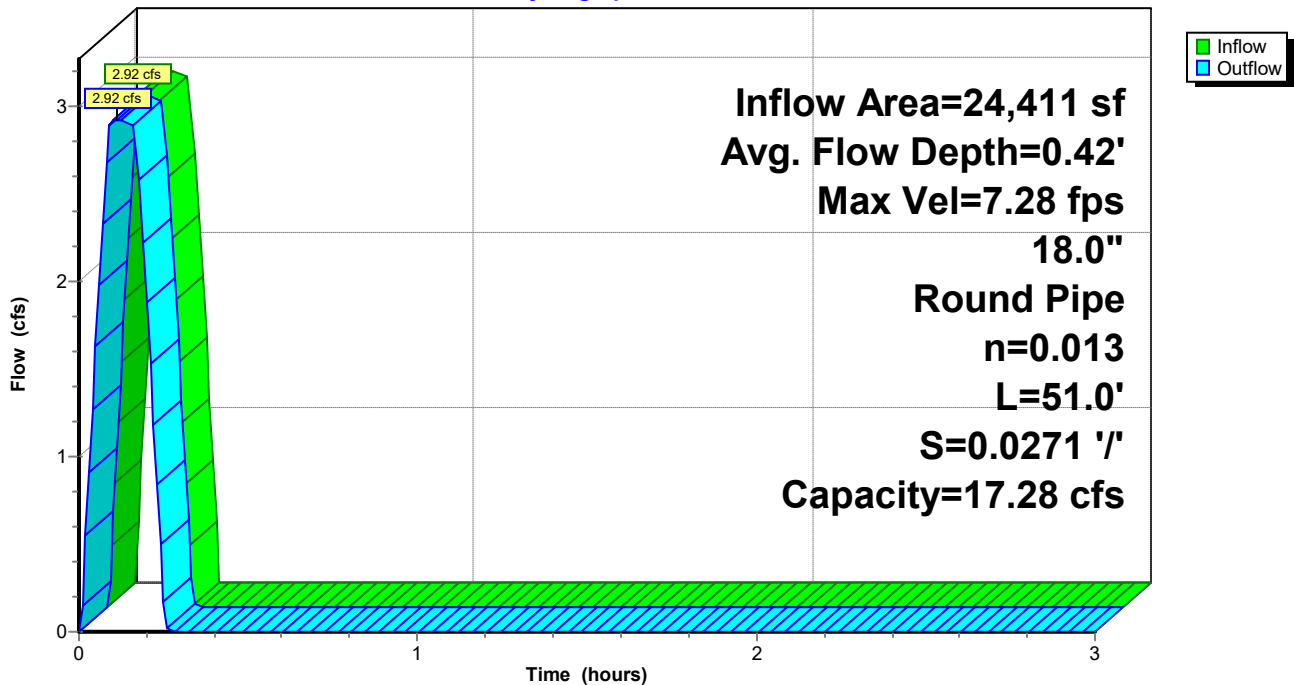

Reach P-A1: Pipe A1

Stage-Discharge

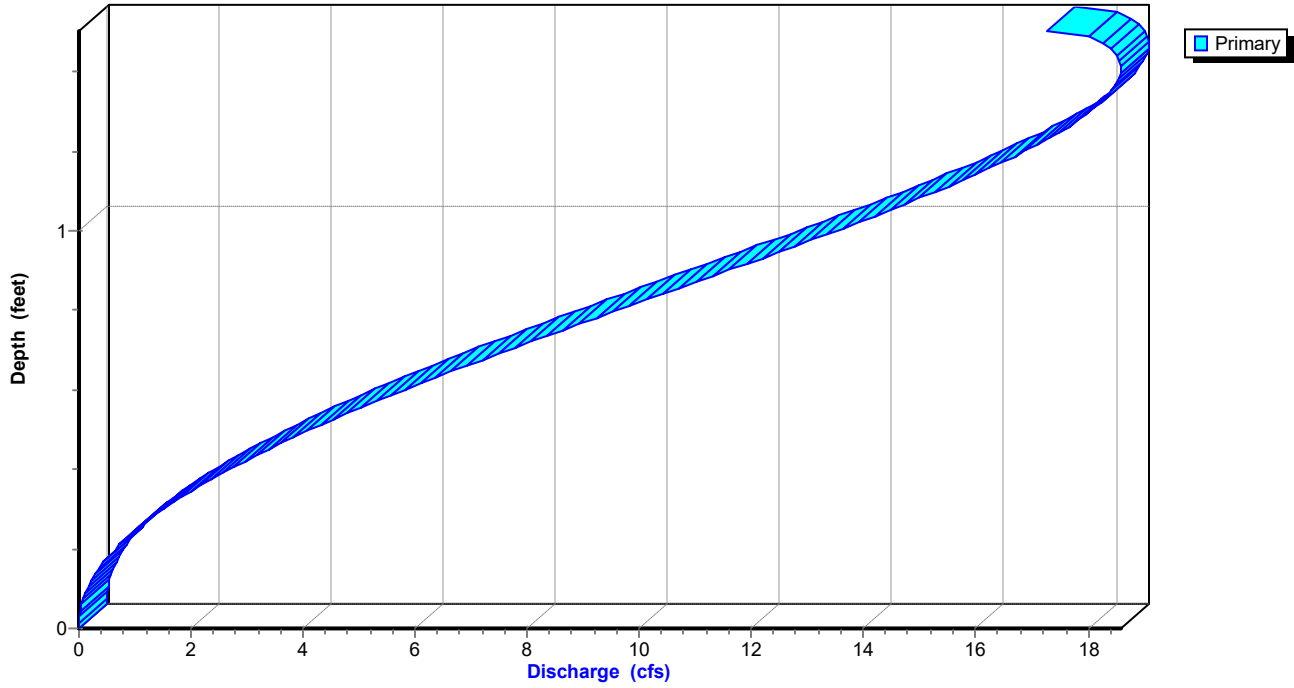

Summerwood Gym 3*AR - Little Rock 25-yr Duration=10 min, Inten=6.72 in/hr*

Prepared by Phillip Lewis Engineering

Printed 1/11/2024

HydroCAD® 10.20-2f s/n 12520 © 2022 HydroCAD Software Solutions LLC

Stage-Area-Storage for Reach P-A1: Pipe A1

Elevation (feet)	End-Area (sq-ft)	Storage (cubic-feet)	Elevation (feet)	End-Area (sq-ft)	Storage (cubic-feet)
408.33	0.0	0	409.37	1.3	67
408.35	0.0	0	409.39	1.3	68
408.37	0.0	1	409.41	1.4	69
408.39	0.0	1	409.43	1.4	71
408.41	0.0	2	409.45	1.4	72
408.43	0.1	3	409.47	1.4	73
408.45	0.1	3	409.49	1.5	75
408.47	0.1	4	409.51	1.5	76
408.49	0.1	5	409.53	1.5	77
408.51	0.1	6	409.55	1.5	78
408.53	0.1	7	409.57	1.6	80
408.55	0.2	8	409.59	1.6	81
408.57	0.2	9	409.61	1.6	82
408.59	0.2	10	409.63	1.6	83
408.61	0.2	12	409.65	1.6	84
408.63	0.3	13	409.67	1.7	85
408.65	0.3	14	409.69	1.7	86
408.67	0.3	15	409.71	1.7	87
408.69	0.3	17	409.73	1.7	88
408.71	0.4	18	409.75	1.7	88
408.73	0.4	19	409.77	1.7	89
408.75	0.4	21	409.79	1.8	89
408.77	0.4	22	409.81	1.8	90
408.79	0.5	23	409.83	1.8	90
408.81	0.5	25			
408.83	0.5	26			
408.85	0.5	28			
408.87	0.6	29			
408.89	0.6	31			
408.91	0.6	32			
408.93	0.7	34			
408.95	0.7	35			
408.97	0.7	37			
408.99	0.7	38			
409.01	0.8	40			
409.03	0.8	41			
409.05	0.8	43			
409.07	0.9	44			
409.09	0.9	46			
409.11	0.9	47			
409.13	1.0	49			
409.15	1.0	50			
409.17	1.0	52			
409.19	1.0	53			
409.21	1.1	55			
409.23	1.1	56			
409.25	1.1	58			
409.27	1.2	59			
409.29	1.2	61			
409.31	1.2	62			
409.33	1.3	64			
409.35	1.3	65			

Summerwood Gym 3

Prepared by Phillip Lewis Engineering

HydroCAD® 10.20-2f s/n 12520 © 2022 HydroCAD Software Solutions LLC

AR - Little Rock 25-yr Duration=10 min, Inten=6.72 in/hr

Printed 1/11/2024

Summary for Reach P-A2: Pipe A2

Inflow Area = 39,705 sf, 75.04% Impervious, Inflow Depth = 0.92" for 25-yr event
Inflow = 5.09 cfs @ 0.11 hrs, Volume= 3,048 cf
Outflow = 5.09 cfs @ 0.15 hrs, Volume= 3,048 cf, Atten= 0%, Lag= 2.4 min
Routed to Reach P-A3 : Pipe A3

Routing by Stor-Ind+Trans method, Time Span= 0.00-3.00 hrs, dt= 0.01 hrs
Max. Velocity= 6.49 fps, Min. Travel Time= 0.5 min
Avg. Velocity = 2.58 fps, Avg. Travel Time= 1.1 min

Peak Storage= 139 cf @ 0.14 hrs
Average Depth at Peak Storage= 0.68' , Surface Width= 1.49'
Bank-Full Depth= 1.50' Flow Area= 1.8 sf, Capacity= 11.95 cfs

18.0" Round Pipe
n= 0.013 Corrugated PE, smooth interior
Length= 177.0' Slope= 0.0129 '/'
Inlet Invert= 406.85', Outlet Invert= 404.56'

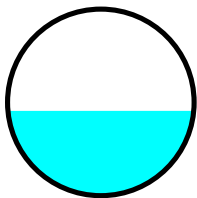

Reach P-A2: Pipe A2

Hydrograph

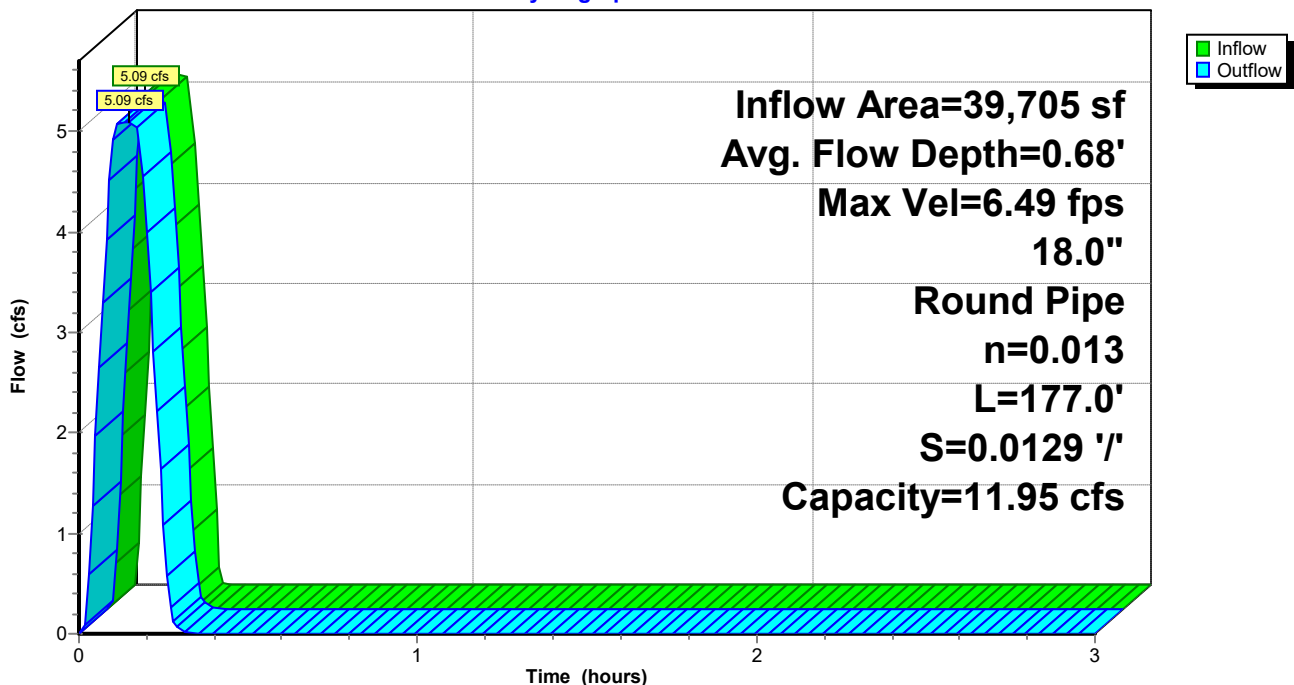

Reach P-A2: Pipe A2

Stage-Discharge

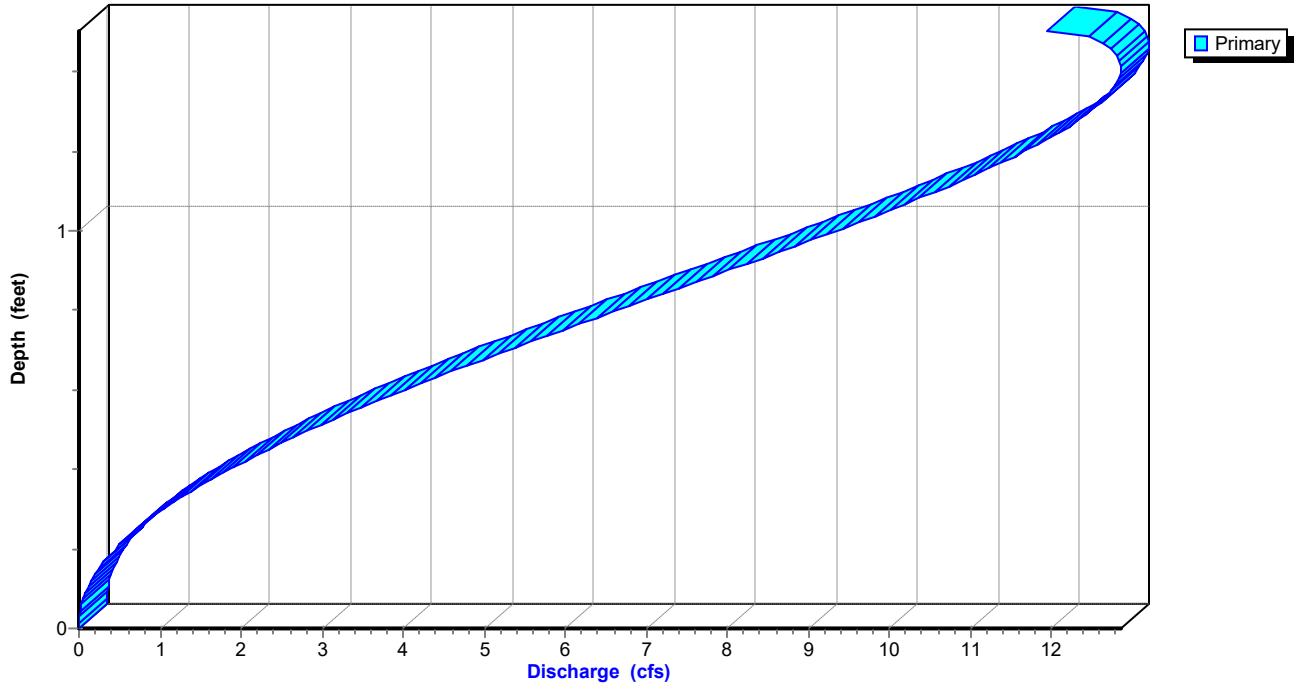

Summerwood Gym 3*AR - Little Rock 25-yr Duration=10 min, Inten=6.72 in/hr*

Prepared by Phillip Lewis Engineering

Printed 1/11/2024

HydroCAD® 10.20-2f s/n 12520 © 2022 HydroCAD Software Solutions LLC

Stage-Area-Storage for Reach P-A2: Pipe A2

Elevation (feet)	End-Area (sq-ft)	Storage (cubic-feet)	Elevation (feet)	End-Area (sq-ft)	Storage (cubic-feet)
406.85	0.0	0	407.89	1.3	231
406.87	0.0	1	407.91	1.3	236
406.89	0.0	2	407.93	1.4	241
406.91	0.0	4	407.95	1.4	246
406.93	0.0	6	407.97	1.4	250
406.95	0.1	9	407.99	1.4	255
406.97	0.1	12	408.01	1.5	260
406.99	0.1	15	408.03	1.5	264
407.01	0.1	18	408.05	1.5	268
407.03	0.1	21	408.07	1.5	272
407.05	0.1	25	408.09	1.6	277
407.07	0.2	28	408.11	1.6	280
407.09	0.2	32	408.13	1.6	284
407.11	0.2	36	408.15	1.6	288
407.13	0.2	40	408.17	1.6	292
407.15	0.3	45	408.19	1.7	295
407.17	0.3	49	408.21	1.7	298
407.19	0.3	53	408.23	1.7	301
407.21	0.3	58	408.25	1.7	304
407.23	0.4	62	408.27	1.7	306
407.25	0.4	67	408.29	1.7	309
407.27	0.4	72	408.31	1.8	310
407.29	0.4	76	408.33	1.8	312
407.31	0.5	81	408.35	1.8	313
407.33	0.5	86			
407.35	0.5	91			
407.37	0.5	96			
407.39	0.6	101			
407.41	0.6	106			
407.43	0.6	112			
407.45	0.7	117			
407.47	0.7	122			
407.49	0.7	127			
407.51	0.7	133			
407.53	0.8	138			
407.55	0.8	143			
407.57	0.8	148			
407.59	0.9	154			
407.61	0.9	159			
407.63	0.9	164			
407.65	1.0	170			
407.67	1.0	175			
407.69	1.0	180			
407.71	1.0	185			
407.73	1.1	191			
407.75	1.1	196			
407.77	1.1	201			
407.79	1.2	206			
407.81	1.2	211			
407.83	1.2	216			
407.85	1.3	222			
407.87	1.3	226			

Summerwood Gym 3

Prepared by Phillip Lewis Engineering

HydroCAD® 10.20-2f s/n 12520 © 2022 HydroCAD Software Solutions LLC

AR - Little Rock 25-yr Duration=10 min, Inten=6.72 in/hr

Printed 1/11/2024

Summary for Reach P-A3: Pipe A3

Inflow Area = 71,768 sf, 58.28% Impervious, Inflow Depth = 0.81" for 25-yr event
Inflow = 8.08 cfs @ 0.17 hrs, Volume= 4,873 cf
Outflow = 8.02 cfs @ 0.17 hrs, Volume= 4,873 cf, Atten= 1%, Lag= 0.2 min
Routed to Reach P-A4 : Pipe A4

Routing by Stor-Ind+Trans method, Time Span= 0.00-3.00 hrs, dt= 0.01 hrs
Max. Velocity= 9.76 fps, Min. Travel Time= 0.2 min
Avg. Velocity= 4.04 fps, Avg. Travel Time= 0.5 min

Peak Storage= 97 cf @ 0.17 hrs
Average Depth at Peak Storage= 0.71' , Surface Width= 1.50'
Bank-Full Depth= 1.50' Flow Area= 1.8 sf, Capacity= 17.65 cfs

18.0" Round Pipe
n= 0.013 Corrugated PE, smooth interior
Length= 118.0' Slope= 0.0282 '/'
Inlet Invert= 404.46', Outlet Invert= 401.13'

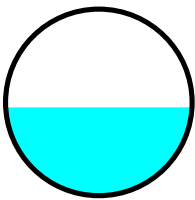

Reach P-A3: Pipe A3

Hydrograph

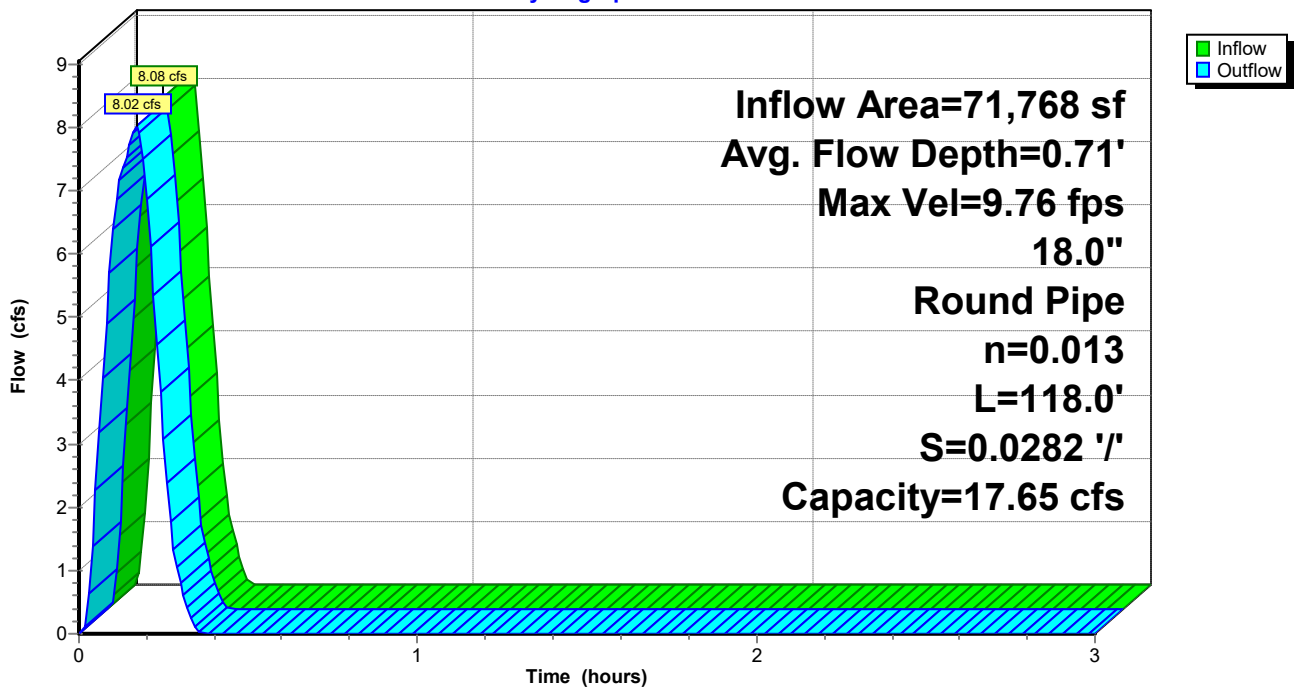

Summerwood Gym 3

Prepared by Phillip Lewis Engineering

HydroCAD® 10.20-2f s/n 12520 © 2022 HydroCAD Software Solutions LLC

AR - Little Rock 25-yr Duration=10 min, Inten=6.72 in/hr

Printed 1/11/2024

Reach P-A3: Pipe A3

Stage-Discharge

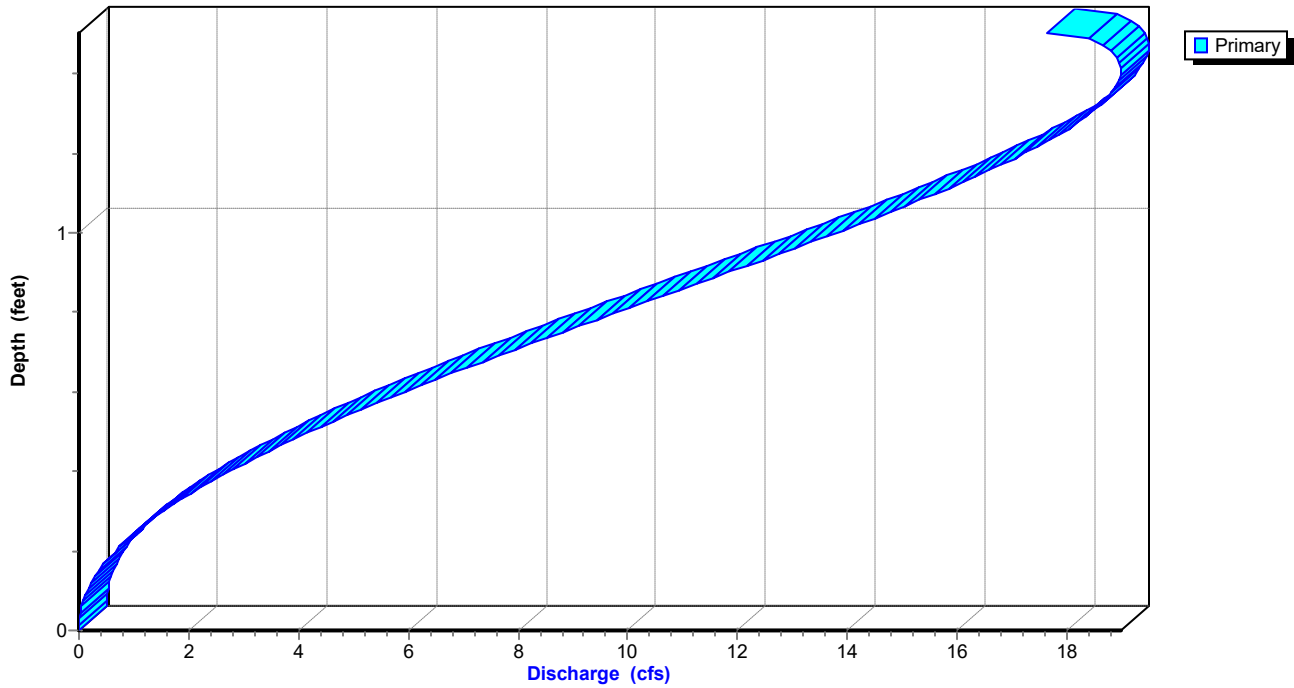

Summerwood Gym 3*AR - Little Rock 25-yr Duration=10 min, Inten=6.72 in/hr*

Prepared by Phillip Lewis Engineering

Printed 1/11/2024

HydroCAD® 10.20-2f s/n 12520 © 2022 HydroCAD Software Solutions LLC

Stage-Area-Storage for Reach P-A3: Pipe A3

Elevation (feet)	End-Area (sq-ft)	Storage (cubic-feet)	Elevation (feet)	End-Area (sq-ft)	Storage (cubic-feet)
404.46	0.0	0	405.50	1.3	154
404.48	0.0	1	405.52	1.3	158
404.50	0.0	2	405.54	1.4	161
404.52	0.0	3	405.56	1.4	164
404.54	0.0	4	405.58	1.4	167
404.56	0.1	6	405.60	1.4	170
404.58	0.1	8	405.62	1.5	173
404.60	0.1	10	405.64	1.5	176
404.62	0.1	12	405.66	1.5	179
404.64	0.1	14	405.68	1.5	182
404.66	0.1	17	405.70	1.6	184
404.68	0.2	19	405.72	1.6	187
404.70	0.2	22	405.74	1.6	190
404.72	0.2	24	405.76	1.6	192
404.74	0.2	27	405.78	1.6	194
404.76	0.3	30	405.80	1.7	197
404.78	0.3	33	405.82	1.7	199
404.80	0.3	35	405.84	1.7	201
404.82	0.3	38	405.86	1.7	203
404.84	0.4	42	405.88	1.7	204
404.86	0.4	45	405.90	1.7	206
404.88	0.4	48	405.92	1.8	207
404.90	0.4	51	405.94	1.8	208
404.92	0.5	54	405.96	1.8	209
404.94	0.5	58			
404.96	0.5	61			
404.98	0.5	64			
405.00	0.6	68			
405.02	0.6	71			
405.04	0.6	74			
405.06	0.7	78			
405.08	0.7	81			
405.10	0.7	85			
405.12	0.7	88			
405.14	0.8	92			
405.16	0.8	95			
405.18	0.8	99			
405.20	0.9	102			
405.22	0.9	106			
405.24	0.9	110			
405.26	1.0	113			
405.28	1.0	117			
405.30	1.0	120			
405.32	1.0	124			
405.34	1.1	127			
405.36	1.1	131			
405.38	1.1	134			
405.40	1.2	138			
405.42	1.2	141			
405.44	1.2	144			
405.46	1.3	148			
405.48	1.3	151			

Summerwood Gym 3

Prepared by Phillip Lewis Engineering

HydroCAD® 10.20-2f s/n 12520 © 2022 HydroCAD Software Solutions LLC

AR - Little Rock 25-yr Duration=10 min, Inten=6.72 in/hr

Printed 1/11/2024

Summary for Reach P-A4: Pipe A4

Inflow Area = 71,768 sf, 58.28% Impervious, Inflow Depth = 0.81" for 25-yr event
Inflow = 8.02 cfs @ 0.17 hrs, Volume= 4,873 cf
Outflow = 7.99 cfs @ 0.18 hrs, Volume= 4,873 cf, Atten= 0%, Lag= 0.4 min
Routed to Pond DP1 : Re-Established East Pond

Routing by Stor-Ind+Trans method, Time Span= 0.00-3.00 hrs, dt= 0.01 hrs
Max. Velocity= 9.74 fps, Min. Travel Time= 0.2 min
Avg. Velocity = 3.84 fps, Avg. Travel Time= 0.6 min

Peak Storage= 108 cf @ 0.17 hrs
Average Depth at Peak Storage= 0.71' , Surface Width= 1.50'
Bank-Full Depth= 1.50' Flow Area= 1.8 sf, Capacity= 17.66 cfs

18.0" Round Pipe
n= 0.013 Corrugated PE, smooth interior
Length= 132.0' Slope= 0.0283 '/'
Inlet Invert= 401.03', Outlet Invert= 397.30'

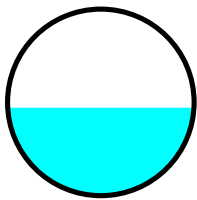

Reach P-A4: Pipe A4

Hydrograph

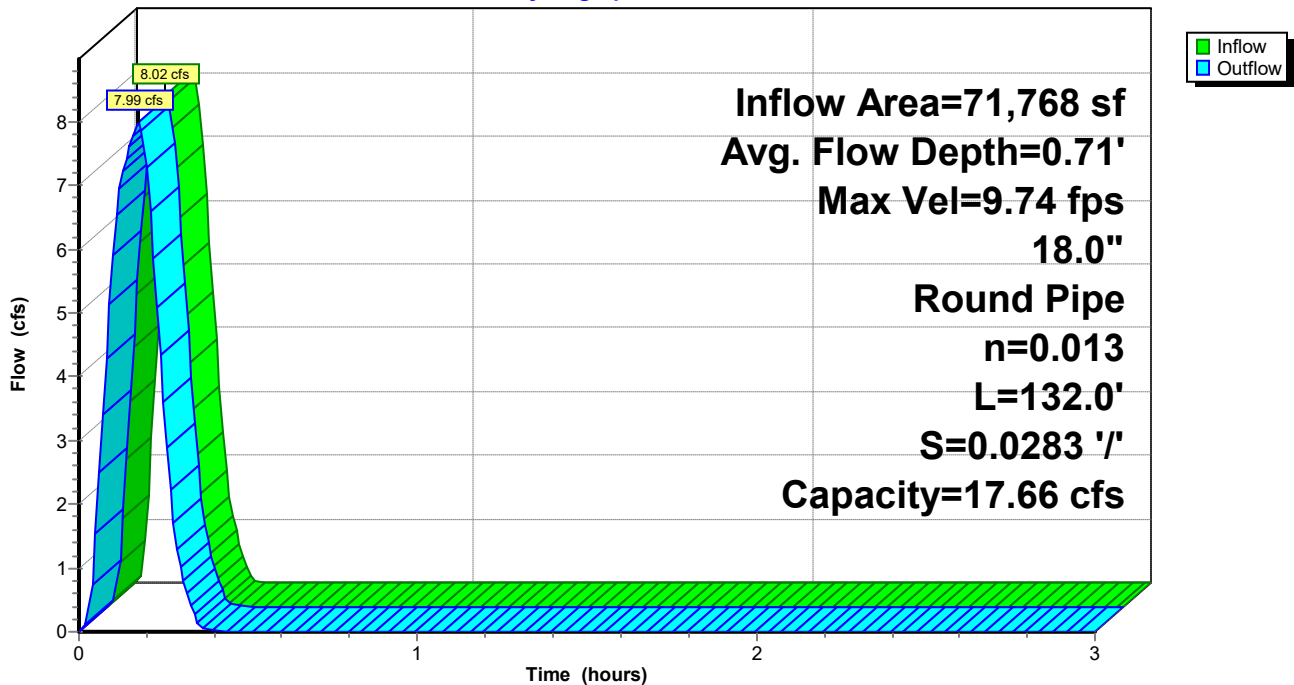

Reach P-A4: Pipe A4

Stage-Discharge

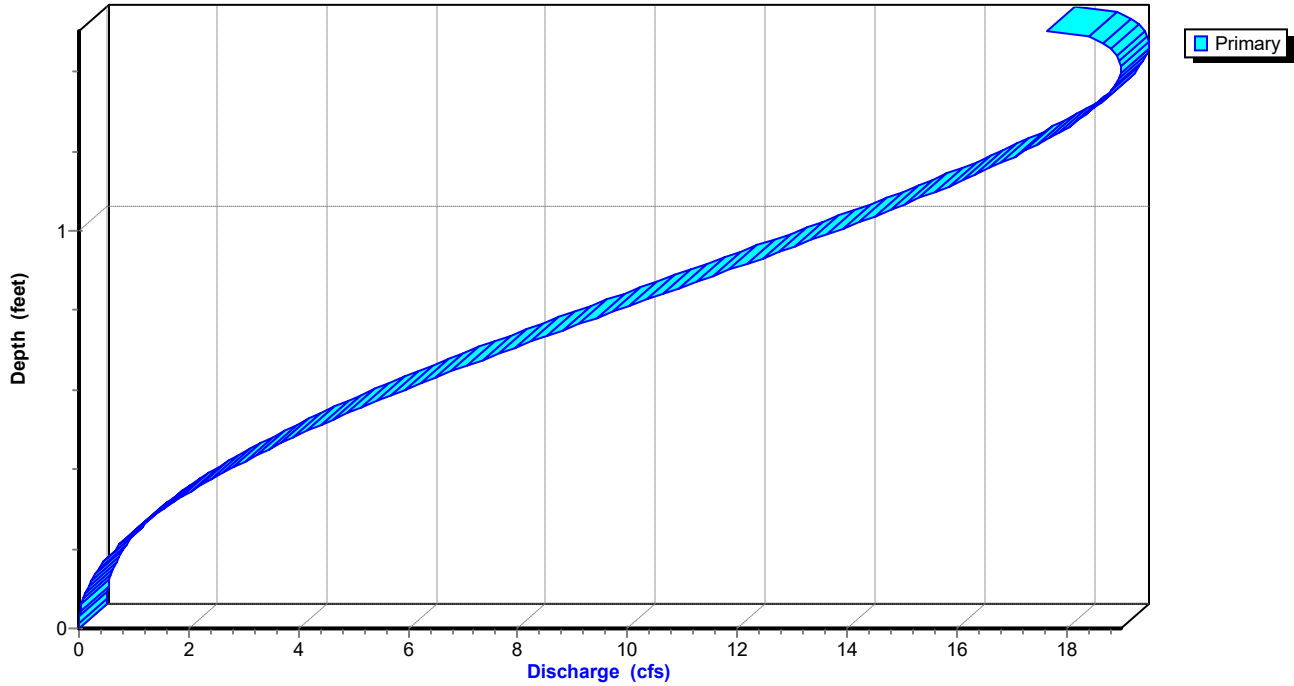

Summerwood Gym 3*AR - Little Rock 25-yr Duration=10 min, Inten=6.72 in/hr*

Prepared by Phillip Lewis Engineering

Printed 1/11/2024

HydroCAD® 10.20-2f s/n 12520 © 2022 HydroCAD Software Solutions LLC

Stage-Area-Storage for Reach P-A4: Pipe A4

Elevation (feet)	End-Area (sq-ft)	Storage (cubic-feet)	Elevation (feet)	End-Area (sq-ft)	Storage (cubic-feet)
401.03	0.0	0	402.07	1.3	173
401.05	0.0	1	402.09	1.3	176
401.07	0.0	2	402.11	1.4	180
401.09	0.0	3	402.13	1.4	183
401.11	0.0	5	402.15	1.4	187
401.13	0.1	7	402.17	1.4	190
401.15	0.1	9	402.19	1.5	194
401.17	0.1	11	402.21	1.5	197
401.19	0.1	13	402.23	1.5	200
401.21	0.1	16	402.25	1.5	203
401.23	0.1	18	402.27	1.6	206
401.25	0.2	21	402.29	1.6	209
401.27	0.2	24	402.31	1.6	212
401.29	0.2	27	402.33	1.6	215
401.31	0.2	30	402.35	1.6	217
401.33	0.3	33	402.37	1.7	220
401.35	0.3	36	402.39	1.7	222
401.37	0.3	40	402.41	1.7	225
401.39	0.3	43	402.43	1.7	227
401.41	0.4	46	402.45	1.7	228
401.43	0.4	50	402.47	1.7	230
401.45	0.4	53	402.49	1.8	232
401.47	0.4	57	402.51	1.8	233
401.49	0.5	61	402.53	1.8	233
401.51	0.5	64			
401.53	0.5	68			
401.55	0.5	72			
401.57	0.6	76			
401.59	0.6	79			
401.61	0.6	83			
401.63	0.7	87			
401.65	0.7	91			
401.67	0.7	95			
401.69	0.7	99			
401.71	0.8	103			
401.73	0.8	107			
401.75	0.8	111			
401.77	0.9	115			
401.79	0.9	119			
401.81	0.9	123			
401.83	1.0	127			
401.85	1.0	130			
401.87	1.0	134			
401.89	1.0	138			
401.91	1.1	142			
401.93	1.1	146			
401.95	1.1	150			
401.97	1.2	154			
401.99	1.2	158			
402.01	1.2	161			
402.03	1.3	165			
402.05	1.3	169			

Summerwood Gym 3

AR - Little Rock 25-yr Duration=10 min, Inten=6.72 in/hr

Prepared by Phillip Lewis Engineering

Printed 1/11/2024

HydroCAD® 10.20-2f s/n 12520 © 2022 HydroCAD Software Solutions LLC

Summary for Pond DP1: Re-Established East Pond

Inflow Area = 132,514 sf, 61.41% Impervious, Inflow Depth = 0.83" for 25-yr event
Inflow = 14.95 cfs @ 0.16 hrs, Volume= 9,164 cf
Outflow = 7.87 cfs @ 0.22 hrs, Volume= 9,164 cf, Atten= 47%, Lag= 3.8 min
Primary = 7.87 cfs @ 0.22 hrs, Volume= 9,164 cf
Routed to Link Post-Dev : APPROX DISCHARGE

Routing by Stor-Ind method, Time Span= 0.00-3.00 hrs, dt= 0.01 hrs
Peak Elev= 398.45' @ 0.22 hrs Storage= 4,803 cf

Plug-Flow detention time= 8.8 min calculated for 9,164 cf (100% of inflow)
Center-of-Mass det. time= 8.7 min (17.5 - 8.8)

Volume	Invert	Avail.Storage	Storage Description
#1	396.00'	8,557 cf	Custom Stage Data Listed below

Elevation (feet)	Inc.Store (cubic-feet)	Cum.Store (cubic-feet)
396.00	0	0
396.50	250	250
397.00	1,092	1,342
398.00	2,387	3,729
399.00	2,405	6,134
400.00	2,423	8,557

Device	Routing	Invert	Outlet Devices
#1	Primary	399.00'	5.0' long Sharp-Crested Rectangular Weir 2 End Contraction(s)
#2	Primary	396.00'	1.1' long Sharp-Crested Rectangular Weir 2 End Contraction(s) 10.0' Crest Height

Primary OutFlow Max=7.86 cfs @ 0.22 hrs HW=398.44' (Free Discharge)
┌1=Sharp-Crested Rectangular Weir (Controls 0.00 cfs)
└2=Sharp-Crested Rectangular Weir (Weir Controls 7.86 cfs @ 5.26 fps)

Summerwood Gym 3

Prepared by Phillip Lewis Engineering

HydroCAD® 10.20-2f s/n 12520 © 2022 HydroCAD Software Solutions LLC

AR - Little Rock 25-yr Duration=10 min, Inten=6.72 in/hr

Printed 1/11/2024

Pond DP1: Re-Established East Pond

Hydrograph

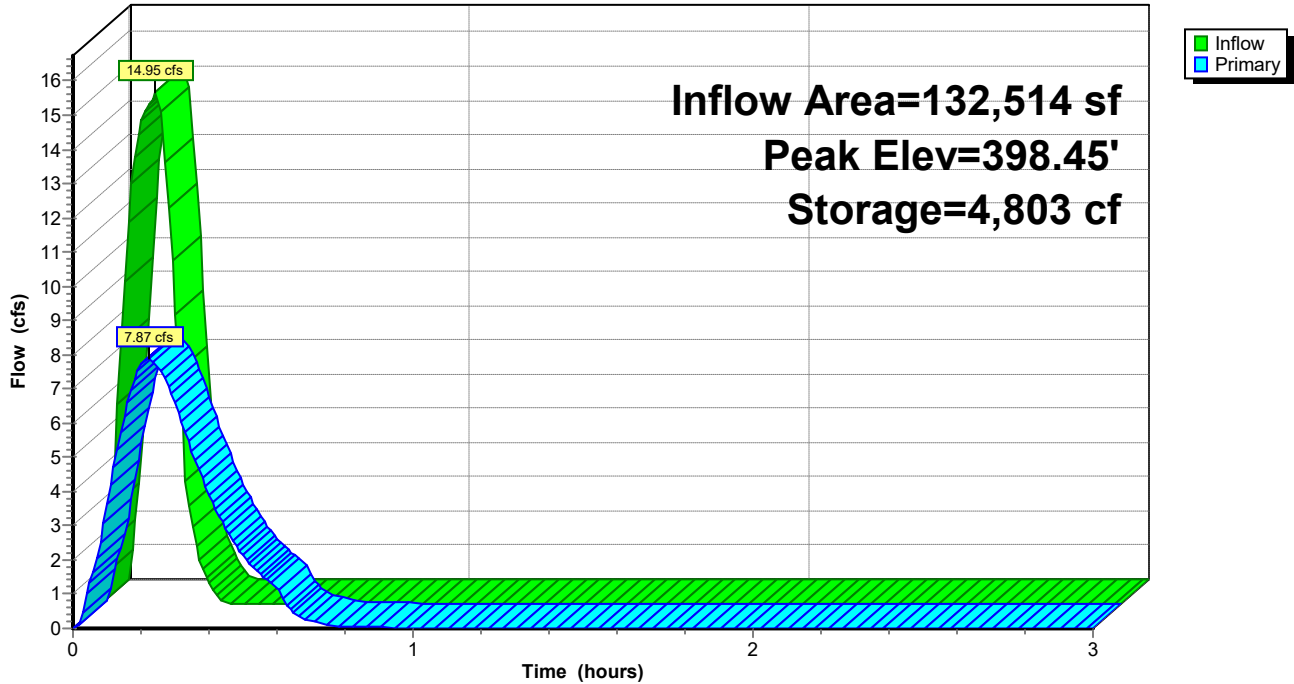

Pond DP1: Re-Established East Pond

Stage-Discharge

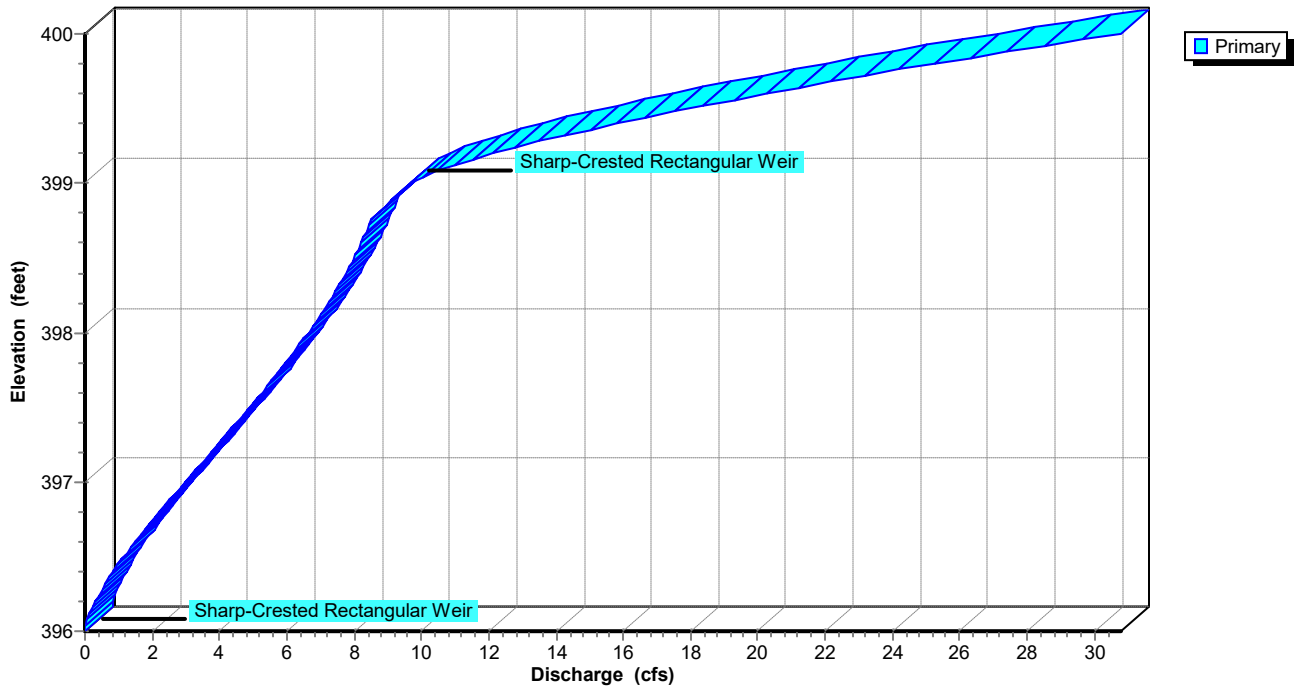

Summerwood Gym 3

Prepared by Phillip Lewis Engineering

HydroCAD® 10.20-2f s/n 12520 © 2022 HydroCAD Software Solutions LLC

AR - Little Rock 25-yr Duration=10 min, Inten=6.72 in/hr

Printed 1/11/2024

Stage-Area-Storage for Pond DP1: Re-Established East Pond

Elevation (feet)	Storage (cubic-feet)	Elevation (feet)	Storage (cubic-feet)
396.00	0	398.60	5,172
396.05	25	398.65	5,292
396.10	50	398.70	5,412
396.15	75	398.75	5,533
396.20	100	398.80	5,653
396.25	125	398.85	5,773
396.30	150	398.90	5,893
396.35	175	398.95	6,014
396.40	200	399.00	6,134
396.45	225	399.05	6,255
396.50	250	399.10	6,376
396.55	359	399.15	6,497
396.60	468	399.20	6,619
396.65	578	399.25	6,740
396.70	687	399.30	6,861
396.75	796	399.35	6,982
396.80	905	399.40	7,103
396.85	1,014	399.45	7,224
396.90	1,124	399.50	7,346
396.95	1,233	399.55	7,467
397.00	1,342	399.60	7,588
397.05	1,461	399.65	7,709
397.10	1,581	399.70	7,830
397.15	1,700	399.75	7,951
397.20	1,819	399.80	8,072
397.25	1,939	399.85	8,194
397.30	2,058	399.90	8,315
397.35	2,177	399.95	8,436
397.40	2,297	400.00	8,557
397.45	2,416		
397.50	2,536		
397.55	2,655		
397.60	2,774		
397.65	2,894		
397.70	3,013		
397.75	3,132		
397.80	3,252		
397.85	3,371		
397.90	3,490		
397.95	3,610		
398.00	3,729		
398.05	3,849		
398.10	3,970		
398.15	4,090		
398.20	4,210		
398.25	4,330		
398.30	4,451		
398.35	4,571		
398.40	4,691		
398.45	4,811		
398.50	4,932		
398.55	5,052		

Summerwood Gym 3

Prepared by Phillip Lewis Engineering

HydroCAD® 10.20-2f s/n 12520 © 2022 HydroCAD Software Solutions LLC

AR - Little Rock 25-yr Duration=10 min, Inten=6.72 in/hr

Printed 1/11/2024

Summary for Link Post-Dev: APPROX DISCHARGE

Inflow Area = 206,166 sf, 64.42% Impervious, Inflow Depth = 0.85" for 25-yr event
Inflow = 15.69 cfs @ 0.17 hrs, Volume= 14,548 cf
Primary = 15.69 cfs @ 0.17 hrs, Volume= 14,548 cf, Atten= 0%, Lag= 0.0 min

Primary outflow = Inflow, Time Span= 0.00-3.00 hrs, dt= 0.01 hrs

Link Post-Dev: APPROX DISCHARGE

Hydrograph

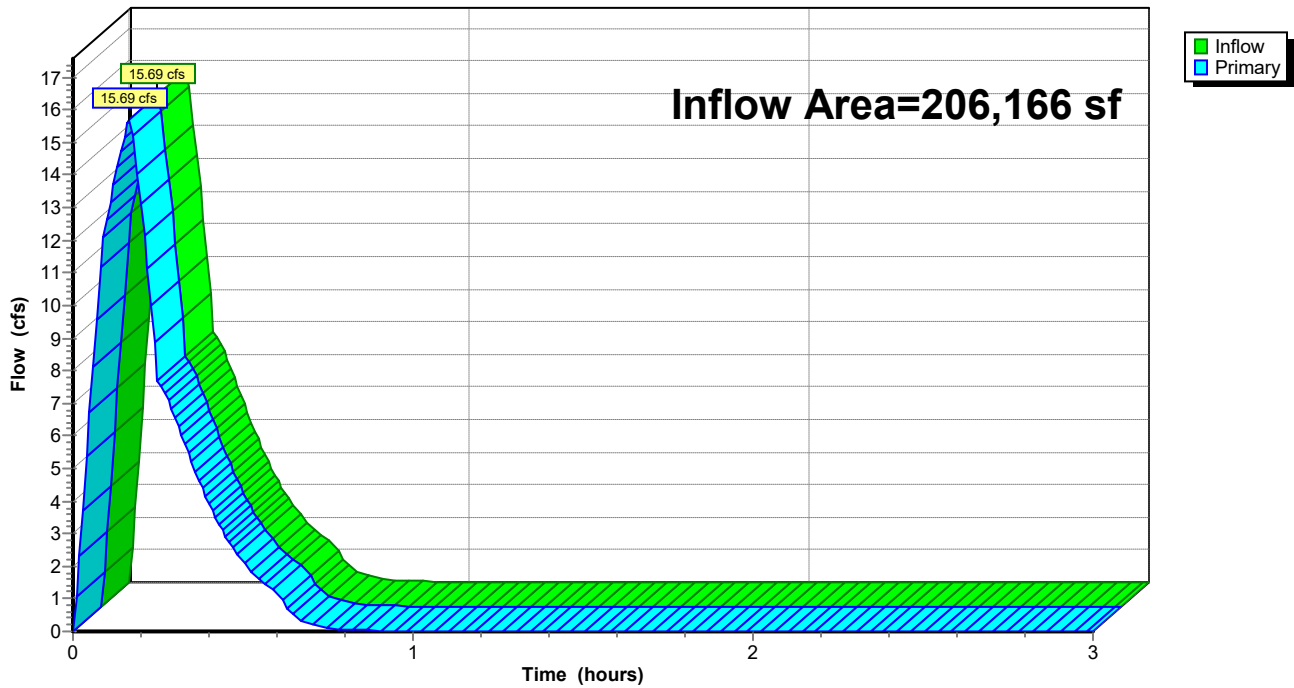

Summerwood Gym 3

AR - Little Rock 100-yr Duration=10 min, Inten=7.98 in/hr

Prepared by Phillip Lewis Engineering

Printed 1/11/2024

HydroCAD® 10.20-2f s/n 12520 © 2022 HydroCAD Software Solutions LLC

Summary for Subcatchment D1: Drainage Basin D1

Runoff = 8.18 cfs @ 0.09 hrs, Volume= 4,900 cf, Depth= 1.21"
 Routed to Link Post-Dev : APPROX DISCHARGE

Runoff by Rational method, Rise/Fall=1.0/1.0 xTc, Time Span= 0.00-3.00 hrs, dt= 0.01 hrs
 AR - Little Rock 100-yr Duration=10 min, Inten=7.98 in/hr

Area (sf)	C	Description
3,421	0.40	Sod Yard
45,236	0.95	Road, Drives, Sidewalks
48,657	0.91	Weighted Average
3,421		7.03% Pervious Area
45,236		92.97% Impervious Area

Tc (min)	Length (feet)	Slope (ft/ft)	Velocity (ft/sec)	Capacity (cfs)	Description
5.0					Direct Entry, Overland Concentrated Flow (Min)

Subcatchment D1: Drainage Basin D1

Hydrograph

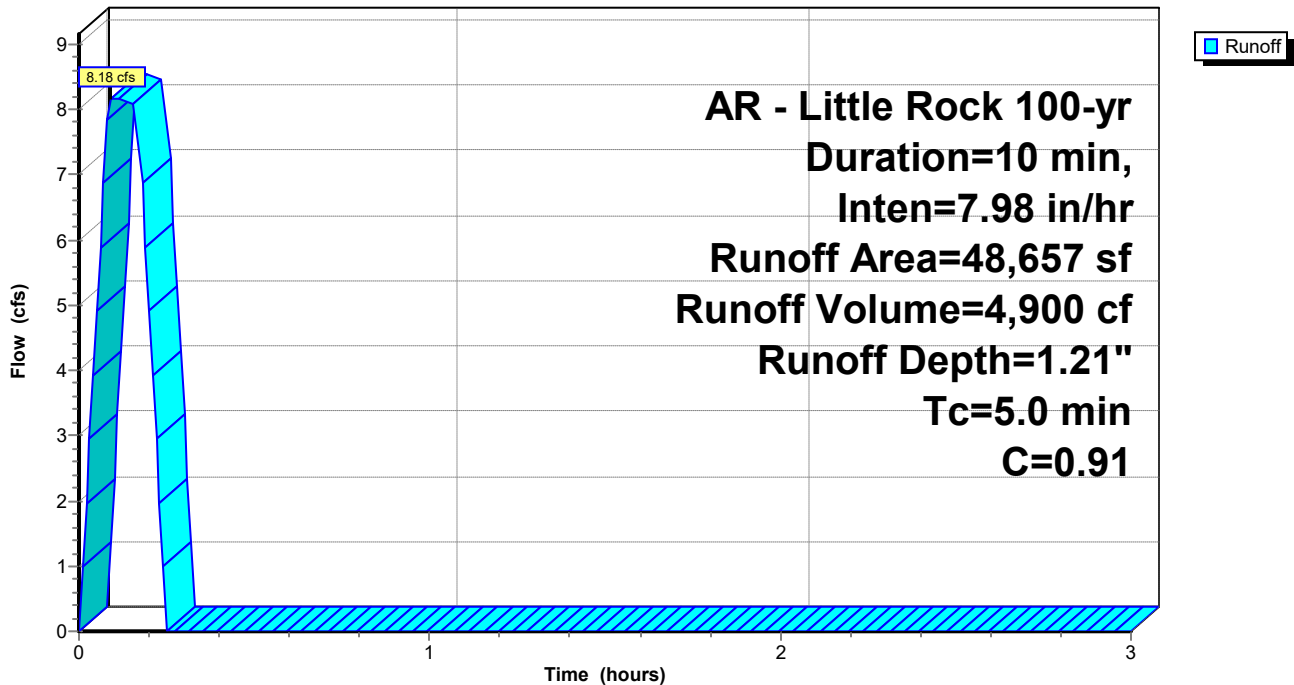

Summerwood Gym 3

Prepared by Phillip Lewis Engineering

HydroCAD® 10.20-2f s/n 12520 © 2022 HydroCAD Software Solutions LLC

AR - Little Rock 100-yr Duration=10 min, Inten=7.98 in/hr

Printed 1/11/2024

Summary for Subcatchment D2: Drainage Basin D2

Runoff = 3.47 cfs @ 0.09 hrs, Volume= 2,080 cf, Depth= 1.02"

Routed to Reach P-A1 : Pipe A1

Runoff by Rational method, Rise/Fall=1.0/1.0 xTc, Time Span= 0.00-3.00 hrs, dt= 0.01 hrs

AR - Little Rock 100-yr Duration=10 min, Inten=7.98 in/hr

Area (sf)	C	Description
8,845	0.45	Rip Rap Embankment
15,566	0.95	Roof, Drives, Sidewalks
24,411	0.77	Weighted Average
8,845		36.23% Pervious Area
15,566		63.77% Impervious Area

Tc (min)	Length (feet)	Slope (ft/ft)	Velocity (ft/sec)	Capacity (cfs)	Description
5.0	415		1.38		Direct Entry, Overland Concentrated Flow (Min)

Subcatchment D2: Drainage Basin D2

Hydrograph

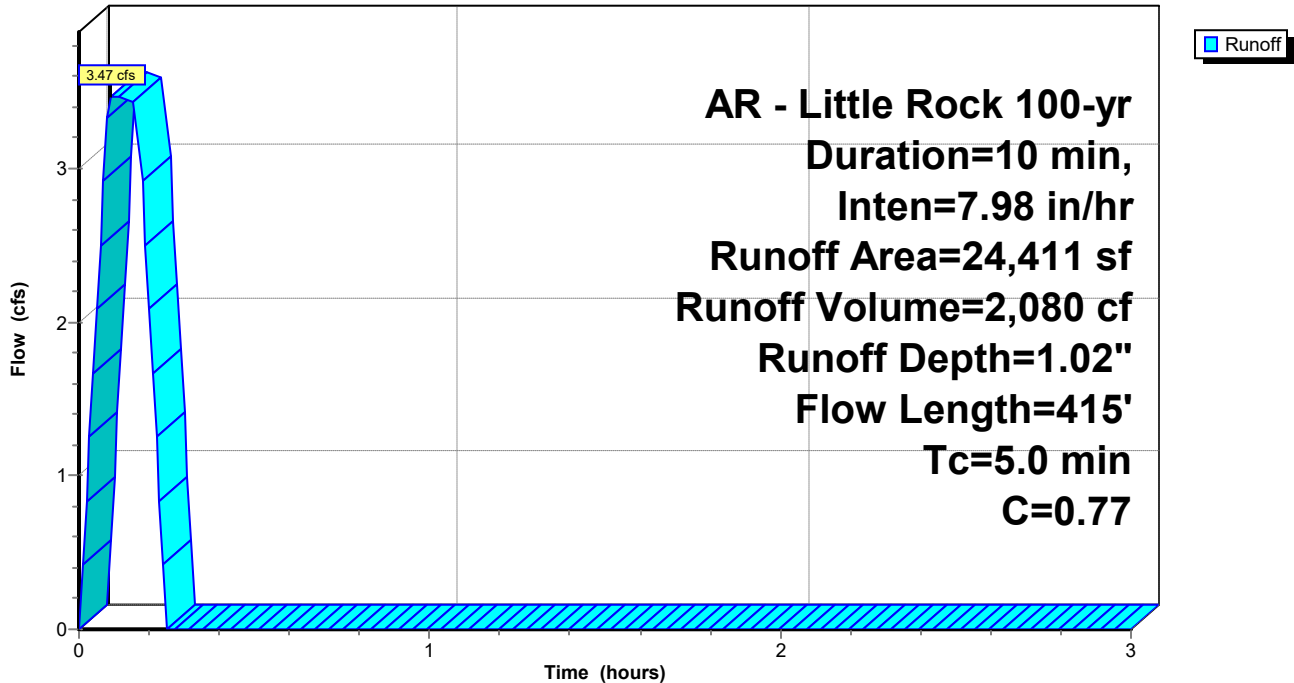

Summerwood Gym 3

Prepared by Phillip Lewis Engineering

HydroCAD® 10.20-2f s/n 12520 © 2022 HydroCAD Software Solutions LLC

AR - Little Rock 100-yr Duration=10 min, Inten=7.98 in/hr

Printed 1/11/2024

Summary for Subcatchment D3: Drainage Basin D3

Runoff = 2.57 cfs @ 0.09 hrs, Volume= 1,540 cf, Depth= 1.21"

Routed to Reach P-A2 : Pipe A2

Runoff by Rational method, Rise/Fall=1.0/1.0 xTc, Time Span= 0.00-3.00 hrs, dt= 0.01 hrs

AR - Little Rock 100-yr Duration=10 min, Inten=7.98 in/hr

Area (sf)	C	Description
1,065	0.40	Sod Yard
14,229	0.95	Paving, Sidewalks
15,294	0.91	Weighted Average
1,065		6.96% Pervious Area
14,229		93.04% Impervious Area

Tc (min)	Length (feet)	Slope (ft/ft)	Velocity (ft/sec)	Capacity (cfs)	Description
5.0	415		1.38		Direct Entry, Overland Concentrated Flow (Min)

Subcatchment D3: Drainage Basin D3

Hydrograph

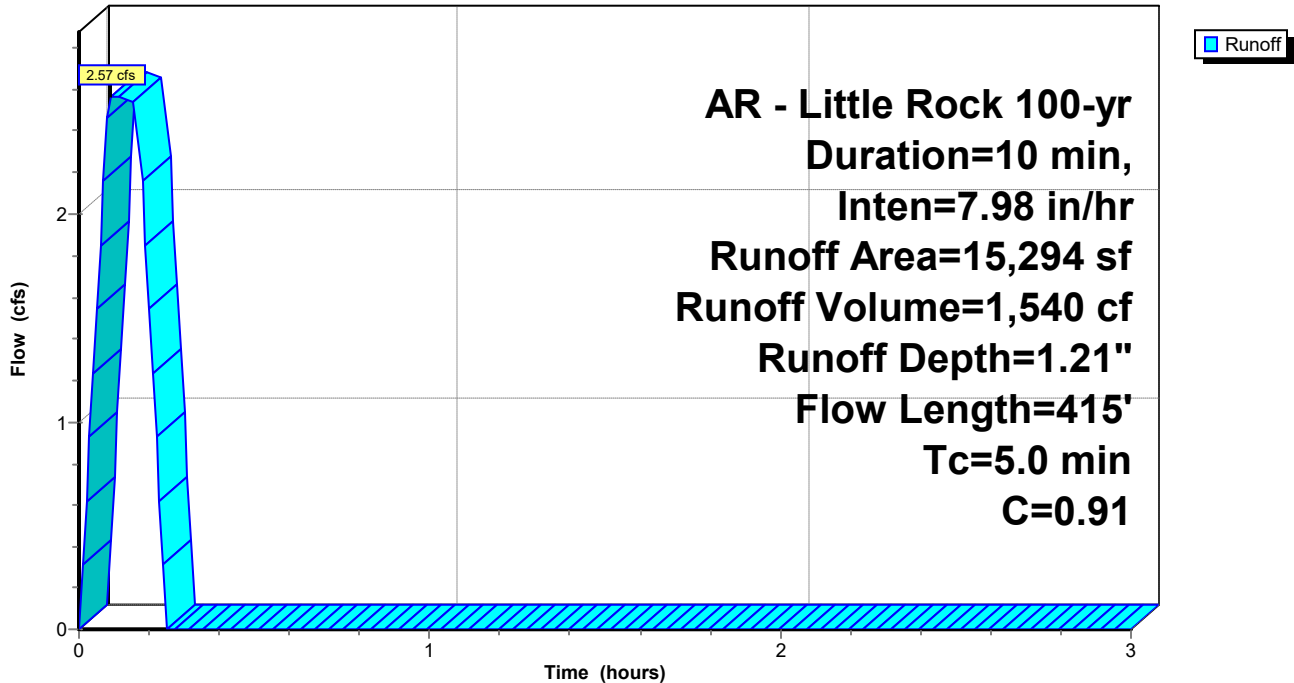

Summerwood Gym 3

AR - Little Rock 100-yr Duration=10 min, Inten=7.98 in/hr

Prepared by Phillip Lewis Engineering

Printed 1/11/2024

HydroCAD® 10.20-2f s/n 12520 © 2022 HydroCAD Software Solutions LLC

Summary for Subcatchment D4: Drainage Basin D4

Runoff = 3.55 cfs @ 0.17 hrs, Volume= 2,167 cf, Depth= 0.81"

Routed to Reach P-A3 : Pipe A3

Runoff by Rational method, Rise/Fall=1.0/1.0 xTc, Time Span= 0.00-3.00 hrs, dt= 0.01 hrs

AR - Little Rock 100-yr Duration=10 min, Inten=7.98 in/hr

Area (sf)	C	Description
20,032	0.40	
12,031	0.95	
32,063	0.61	Weighted Average
20,032		62.48% Pervious Area
12,031		37.52% Impervious Area

Tc (min)	Length (feet)	Slope (ft/ft)	Velocity (ft/sec)	Capacity (cfs)	Description
10.0	415		0.69		Direct Entry, Overland Concentrated Flow (Min)

Subcatchment D4: Drainage Basin D4

Hydrograph

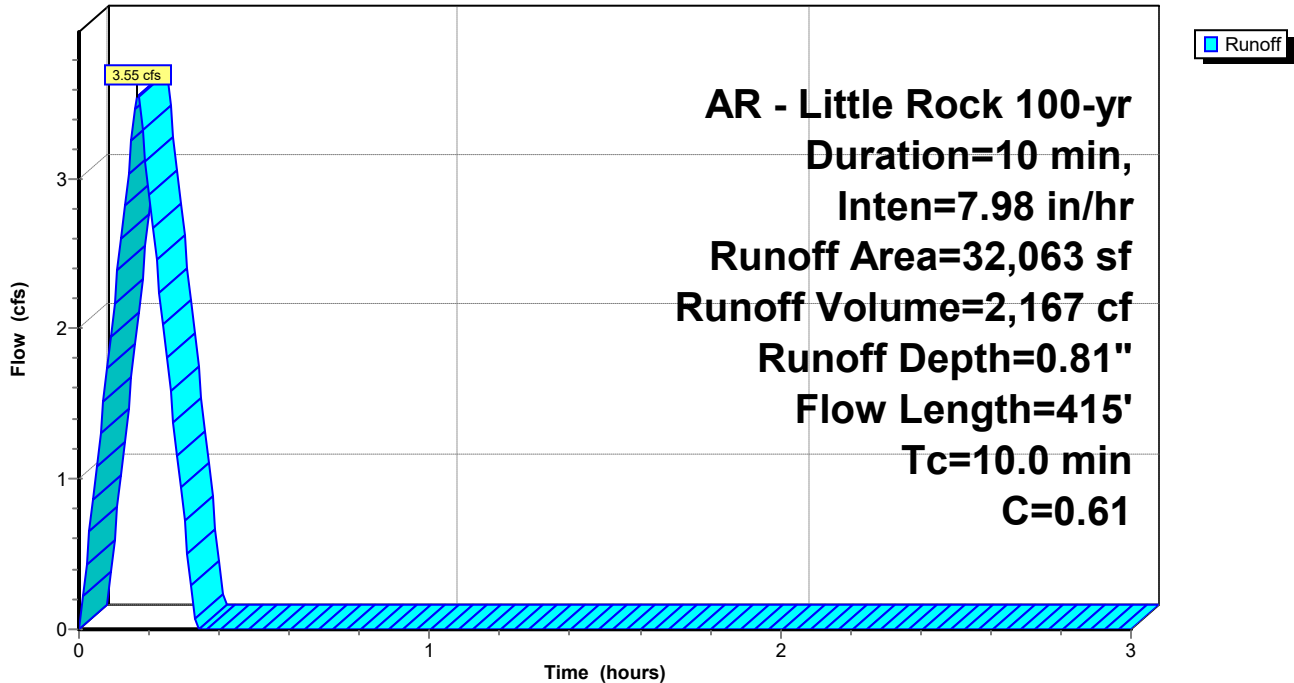

Summerwood Gym 3

Prepared by Phillip Lewis Engineering

HydroCAD® 10.20-2f s/n 12520 © 2022 HydroCAD Software Solutions LLC

AR - Little Rock 100-yr Duration=10 min, Inten=7.98 in/hr

Printed 1/11/2024

Summary for Subcatchment D5: Drainage Basin D5

Runoff = 5.15 cfs @ 0.09 hrs, Volume= 3,087 cf, Depth= 0.89"
 Routed to Pond DP1 : Re-Established East Pond

Runoff by Rational method, Rise/Fall=1.0/1.0 xTc, Time Span= 0.00-3.00 hrs, dt= 0.01 hrs
 AR - Little Rock 100-yr Duration=10 min, Inten=7.98 in/hr

Area (sf)	C	Description
21,201	0.40	Sod Yard, Natural Vegetation
20,437	0.95	Paving, Sidewalks
41,638	0.67	Weighted Average
21,201		50.92% Pervious Area
20,437		49.08% Impervious Area

Tc (min)	Length (feet)	Slope (ft/ft)	Velocity (ft/sec)	Capacity (cfs)	Description
5.0					Direct Entry, Overland Concentrated Flow (Min)

Subcatchment D5: Drainage Basin D5

Hydrograph

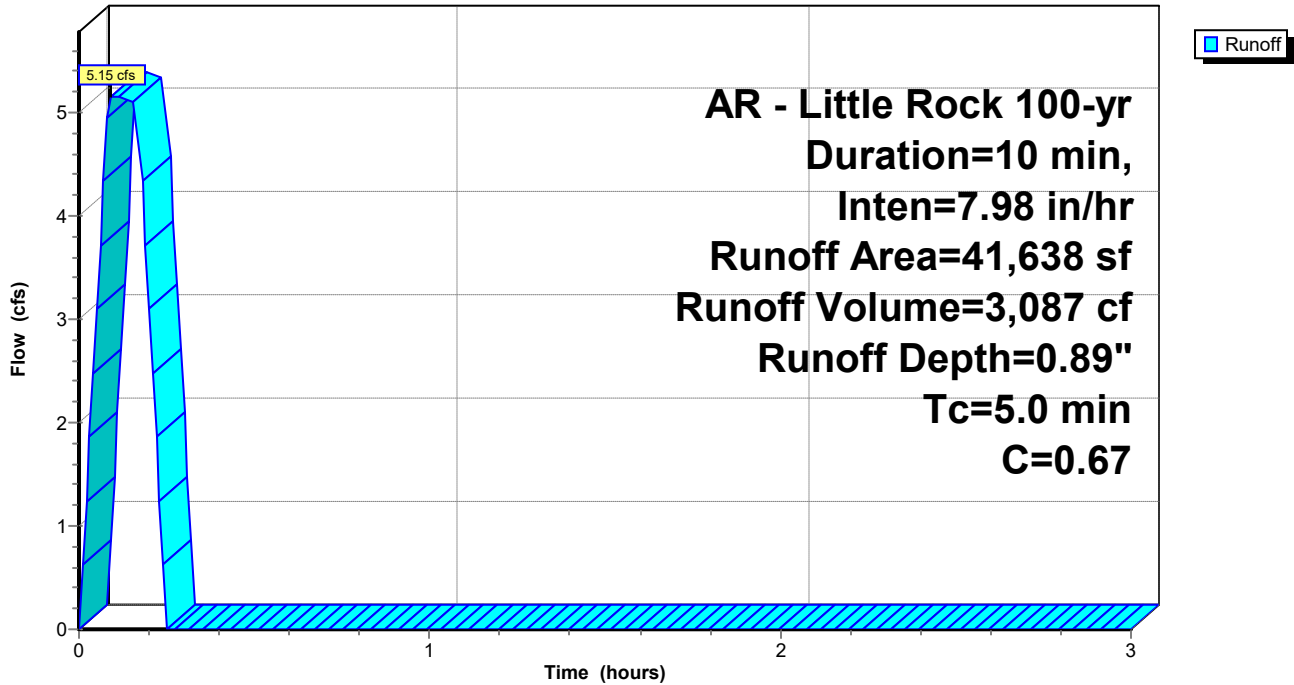

Summerwood Gym 3

AR - Little Rock 100-yr Duration=10 min, Inten=7.98 in/hr

Prepared by Phillip Lewis Engineering

Printed 1/11/2024

HydroCAD® 10.20-2f s/n 12520 © 2022 HydroCAD Software Solutions LLC

Summary for Subcatchment D6: Drainage Basin D6

Runoff = 3.35 cfs @ 0.09 hrs, Volume= 2,009 cf, Depth= 1.26"
 Routed to Pond DP1 : Re-Established East Pond

Runoff by Rational method, Rise/Fall=1.0/1.0 xTc, Time Span= 0.00-3.00 hrs, dt= 0.01 hrs
 AR - Little Rock 100-yr Duration=10 min, Inten=7.98 in/hr

Area (sf)	C	Description
19,108	0.95	Roof
19,108		100.00% Impervious Area

Tc (min)	Length (feet)	Slope (ft/ft)	Velocity (ft/sec)	Capacity (cfs)	Description
5.0					Direct Entry, Overland Concentrated Flow (Min)

Subcatchment D6: Drainage Basin D6

Hydrograph

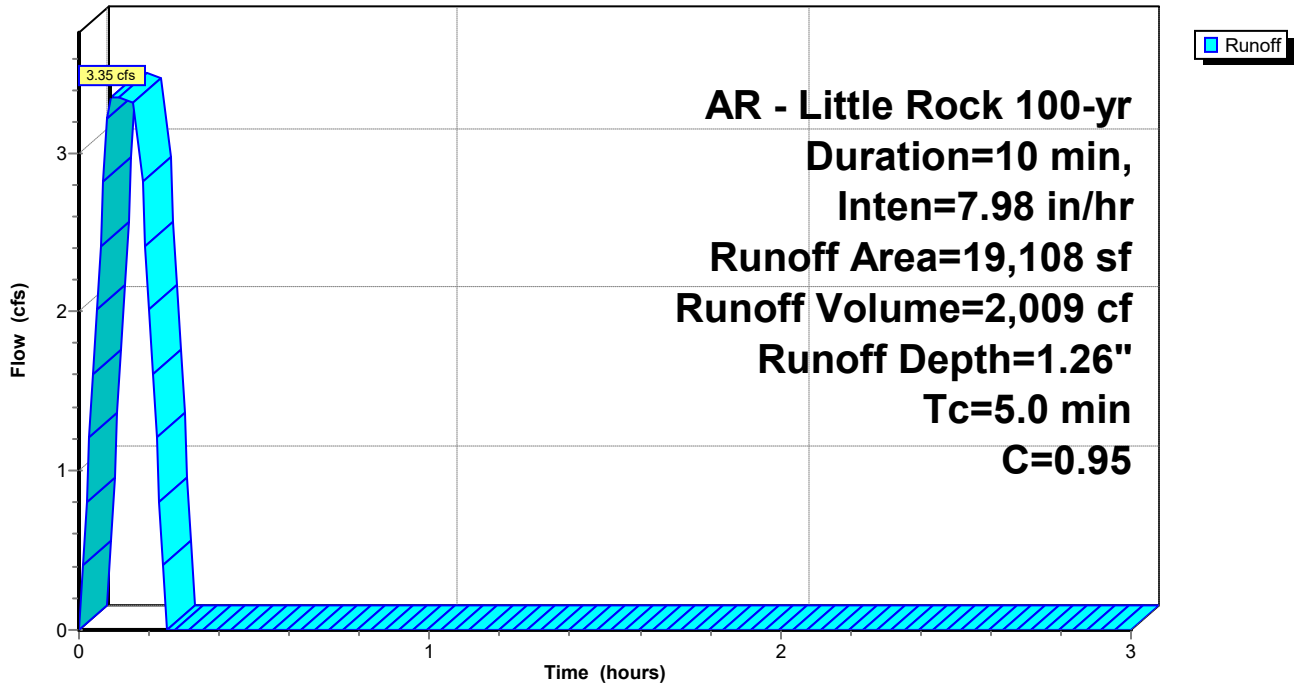

Summerwood Gym 3

Prepared by Phillip Lewis Engineering

HydroCAD® 10.20-2f s/n 12520 © 2022 HydroCAD Software Solutions LLC

AR - Little Rock 100-yr Duration=10 min, Inten=7.98 in/hr

Printed 1/11/2024

Summary for Subcatchment D7: Drainage Basin D7

Runoff = 2.49 cfs @ 0.09 hrs, Volume= 1,494 cf, Depth= 0.72"
 Routed to Link Post-Dev : APPROX DISCHARGE

Runoff by Rational method, Rise/Fall=1.0/1.0 xTc, Time Span= 0.00-3.00 hrs, dt= 0.01 hrs
 AR - Little Rock 100-yr Duration=10 min, Inten=7.98 in/hr

Area (sf)	C	Description
18,798	0.40	Sod Yard, Natural Vegetation
6,197	0.95	Paving, Sidewalks
24,995	0.54	Weighted Average
18,798		75.21% Pervious Area
6,197		24.79% Impervious Area

Tc (min)	Length (feet)	Slope (ft/ft)	Velocity (ft/sec)	Capacity (cfs)	Description
5.0					Direct Entry, Overland Concentrated Flow (Min)

Subcatchment D7: Drainage Basin D7

Hydrograph

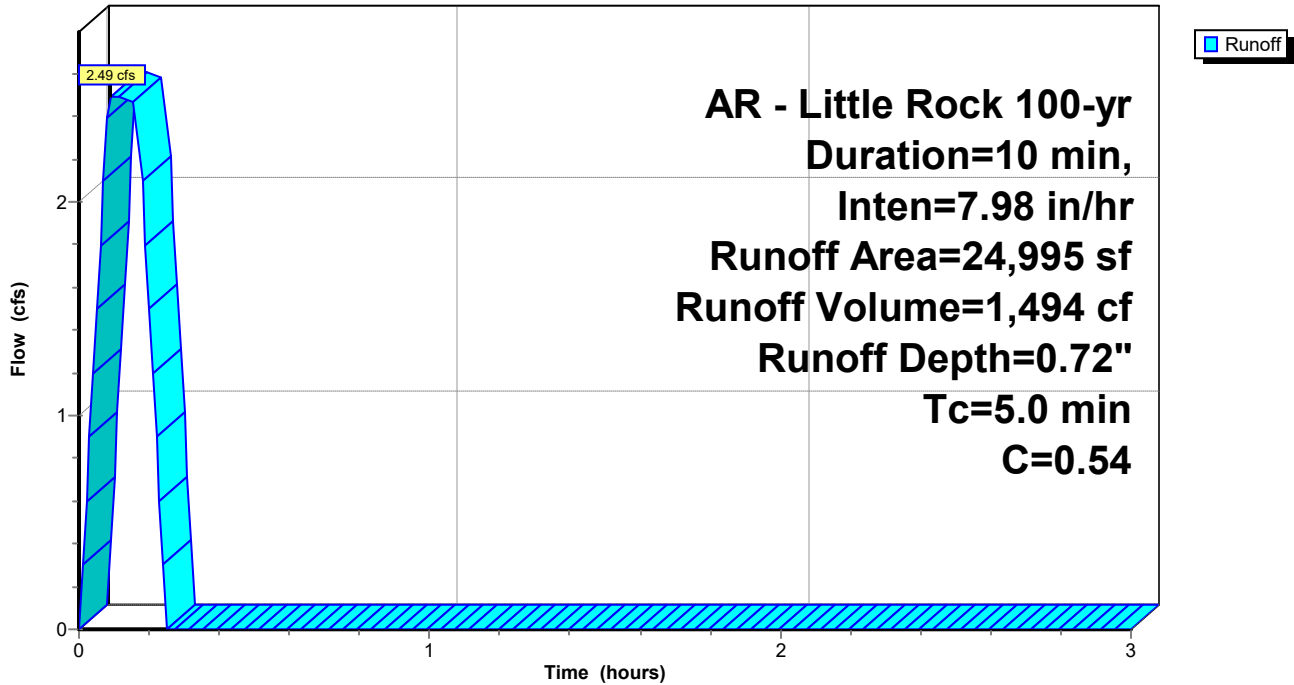

Summerwood Gym 3

AR - Little Rock 100-yr Duration=10 min, Inten=7.98 in/hr

Prepared by Phillip Lewis Engineering

Printed 1/11/2024

HydroCAD® 10.20-2f s/n 12520 © 2022 HydroCAD Software Solutions LLC

Summary for Reach P-A1: Pipe A1

Inflow Area = 24,411 sf, 63.77% Impervious, Inflow Depth = 1.02" for 100-yr event
Inflow = 3.47 cfs @ 0.09 hrs, Volume= 2,080 cf
Outflow = 3.47 cfs @ 0.11 hrs, Volume= 2,080 cf, Atten= 0%, Lag= 1.2 min
Routed to Reach P-A2 : Pipe A2

Routing by Stor-Ind+Trans method, Time Span= 0.00-3.00 hrs, dt= 0.01 hrs
Max. Velocity= 7.65 fps, Min. Travel Time= 0.1 min
Avg. Velocity= 6.08 fps, Avg. Travel Time= 0.1 min

Peak Storage= 23 cf @ 0.09 hrs
Average Depth at Peak Storage= 0.46' , Surface Width= 1.38'
Bank-Full Depth= 1.50' Flow Area= 1.8 sf, Capacity= 17.28 cfs

18.0" Round Pipe
n= 0.013 Corrugated PE, smooth interior
Length= 51.0' Slope= 0.0271 '/'
Inlet Invert= 408.33', Outlet Invert= 406.95'

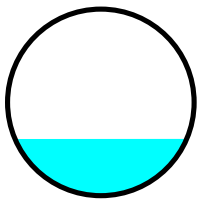

Reach P-A1: Pipe A1

Hydrograph

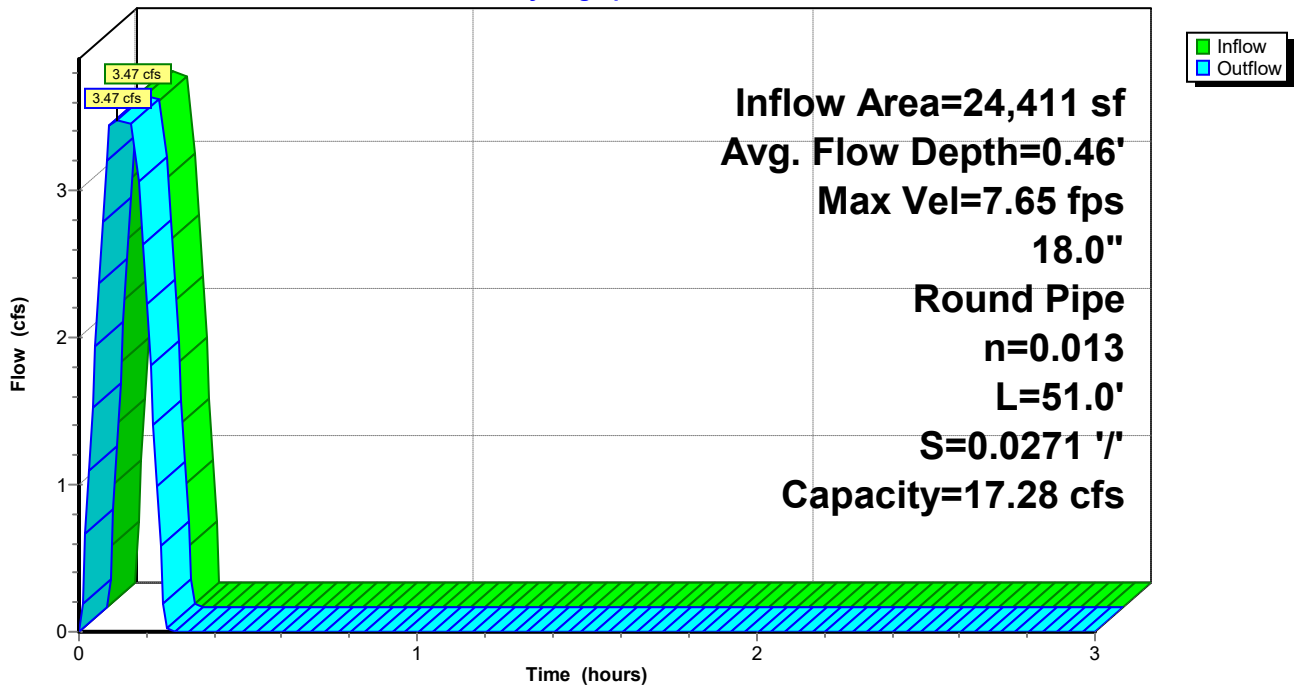

Reach P-A1: Pipe A1

Stage-Discharge

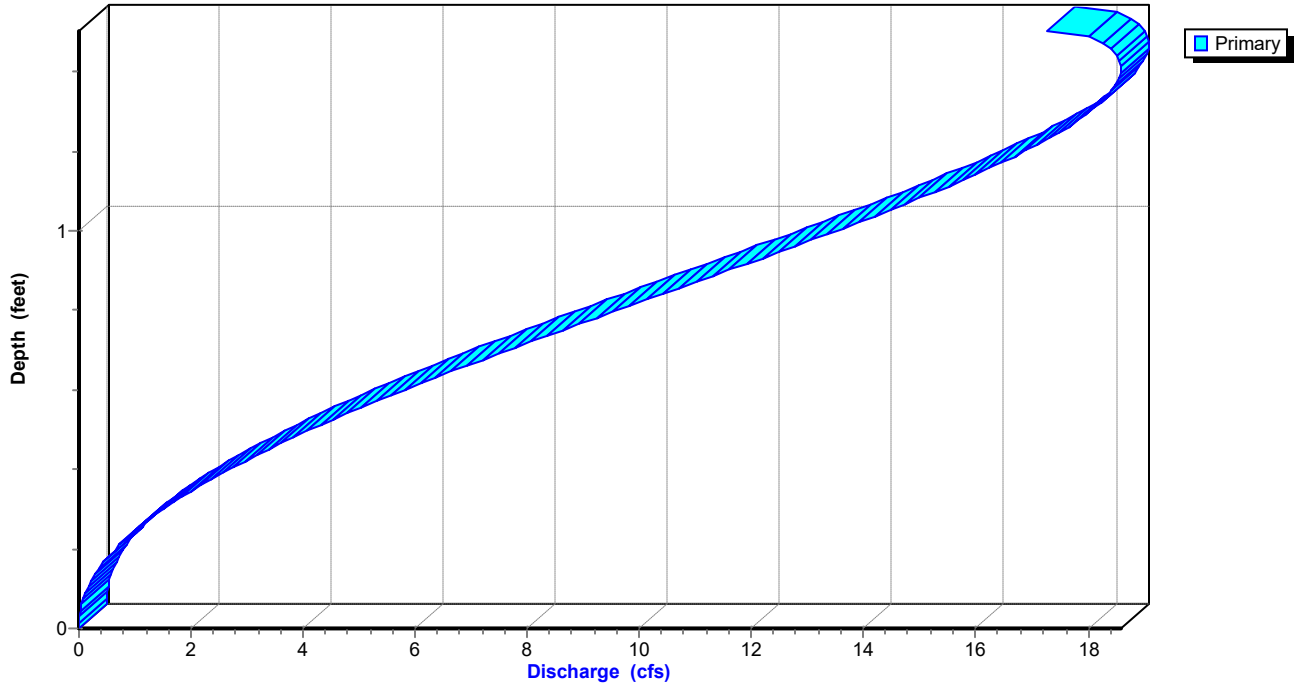

Summerwood Gym 3*AR - Little Rock 100-yr Duration=10 min, Inten=7.98 in/hr*

Prepared by Phillip Lewis Engineering

Printed 1/11/2024

HydroCAD® 10.20-2f s/n 12520 © 2022 HydroCAD Software Solutions LLC

Stage-Area-Storage for Reach P-A1: Pipe A1

Elevation (feet)	End-Area (sq-ft)	Storage (cubic-feet)	Elevation (feet)	End-Area (sq-ft)	Storage (cubic-feet)
408.33	0.0	0	409.37	1.3	67
408.35	0.0	0	409.39	1.3	68
408.37	0.0	1	409.41	1.4	69
408.39	0.0	1	409.43	1.4	71
408.41	0.0	2	409.45	1.4	72
408.43	0.1	3	409.47	1.4	73
408.45	0.1	3	409.49	1.5	75
408.47	0.1	4	409.51	1.5	76
408.49	0.1	5	409.53	1.5	77
408.51	0.1	6	409.55	1.5	78
408.53	0.1	7	409.57	1.6	80
408.55	0.2	8	409.59	1.6	81
408.57	0.2	9	409.61	1.6	82
408.59	0.2	10	409.63	1.6	83
408.61	0.2	12	409.65	1.6	84
408.63	0.3	13	409.67	1.7	85
408.65	0.3	14	409.69	1.7	86
408.67	0.3	15	409.71	1.7	87
408.69	0.3	17	409.73	1.7	88
408.71	0.4	18	409.75	1.7	88
408.73	0.4	19	409.77	1.7	89
408.75	0.4	21	409.79	1.8	89
408.77	0.4	22	409.81	1.8	90
408.79	0.5	23	409.83	1.8	90
408.81	0.5	25			
408.83	0.5	26			
408.85	0.5	28			
408.87	0.6	29			
408.89	0.6	31			
408.91	0.6	32			
408.93	0.7	34			
408.95	0.7	35			
408.97	0.7	37			
408.99	0.7	38			
409.01	0.8	40			
409.03	0.8	41			
409.05	0.8	43			
409.07	0.9	44			
409.09	0.9	46			
409.11	0.9	47			
409.13	1.0	49			
409.15	1.0	50			
409.17	1.0	52			
409.19	1.0	53			
409.21	1.1	55			
409.23	1.1	56			
409.25	1.1	58			
409.27	1.2	59			
409.29	1.2	61			
409.31	1.2	62			
409.33	1.3	64			
409.35	1.3	65			

Summerwood Gym 3

AR - Little Rock 100-yr Duration=10 min, Inten=7.98 in/hr

Prepared by Phillip Lewis Engineering

Printed 1/11/2024

HydroCAD® 10.20-2f s/n 12520 © 2022 HydroCAD Software Solutions LLC

Summary for Reach P-A2: Pipe A2

Inflow Area = 39,705 sf, 75.04% Impervious, Inflow Depth = 1.09" for 100-yr event
Inflow = 6.04 cfs @ 0.11 hrs, Volume= 3,620 cf
Outflow = 6.04 cfs @ 0.15 hrs, Volume= 3,620 cf, Atten= 0%, Lag= 2.4 min
Routed to Reach P-A3 : Pipe A3

Routing by Stor-Ind+Trans method, Time Span= 0.00-3.00 hrs, dt= 0.01 hrs
Max. Velocity= 6.78 fps, Min. Travel Time= 0.4 min
Avg. Velocity = 2.68 fps, Avg. Travel Time= 1.1 min

Peak Storage= 158 cf @ 0.12 hrs
Average Depth at Peak Storage= 0.76' , Surface Width= 1.50'
Bank-Full Depth= 1.50' Flow Area= 1.8 sf, Capacity= 11.95 cfs

18.0" Round Pipe
n= 0.013 Corrugated PE, smooth interior
Length= 177.0' Slope= 0.0129 '/'
Inlet Invert= 406.85', Outlet Invert= 404.56'

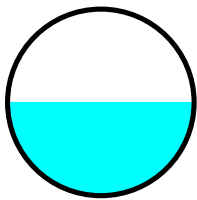

Reach P-A2: Pipe A2

Hydrograph

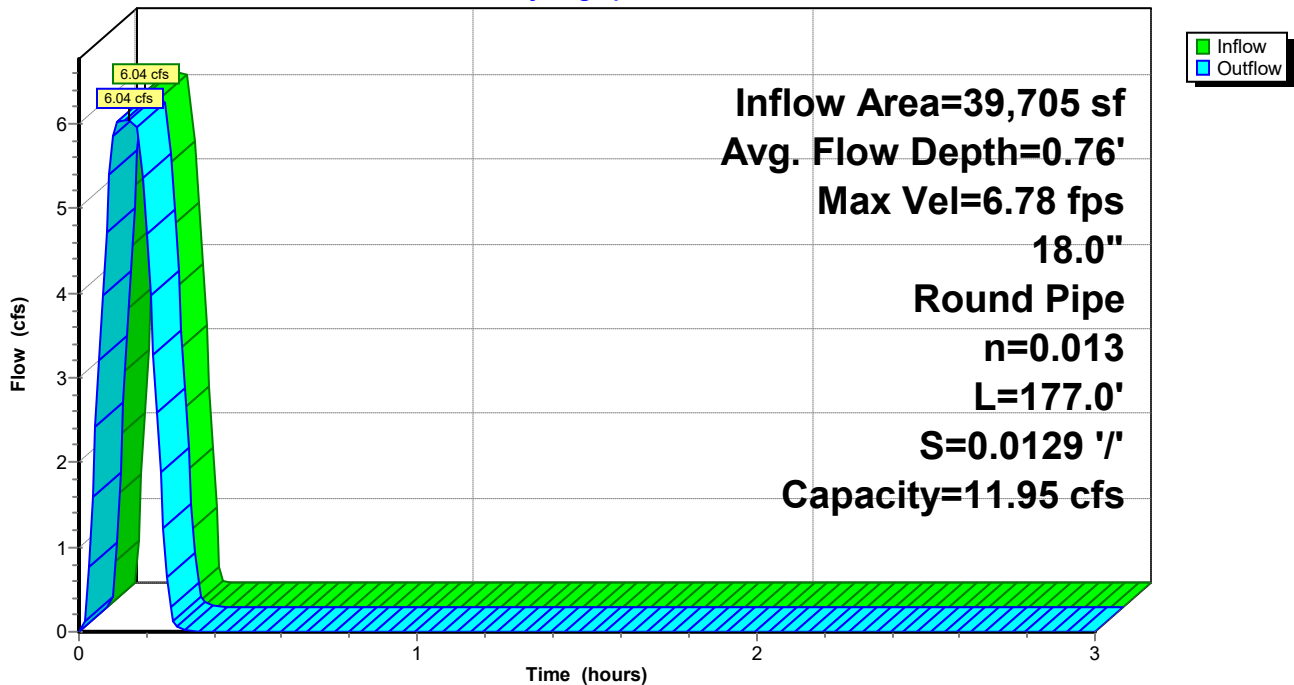

Reach P-A2: Pipe A2

Stage-Discharge

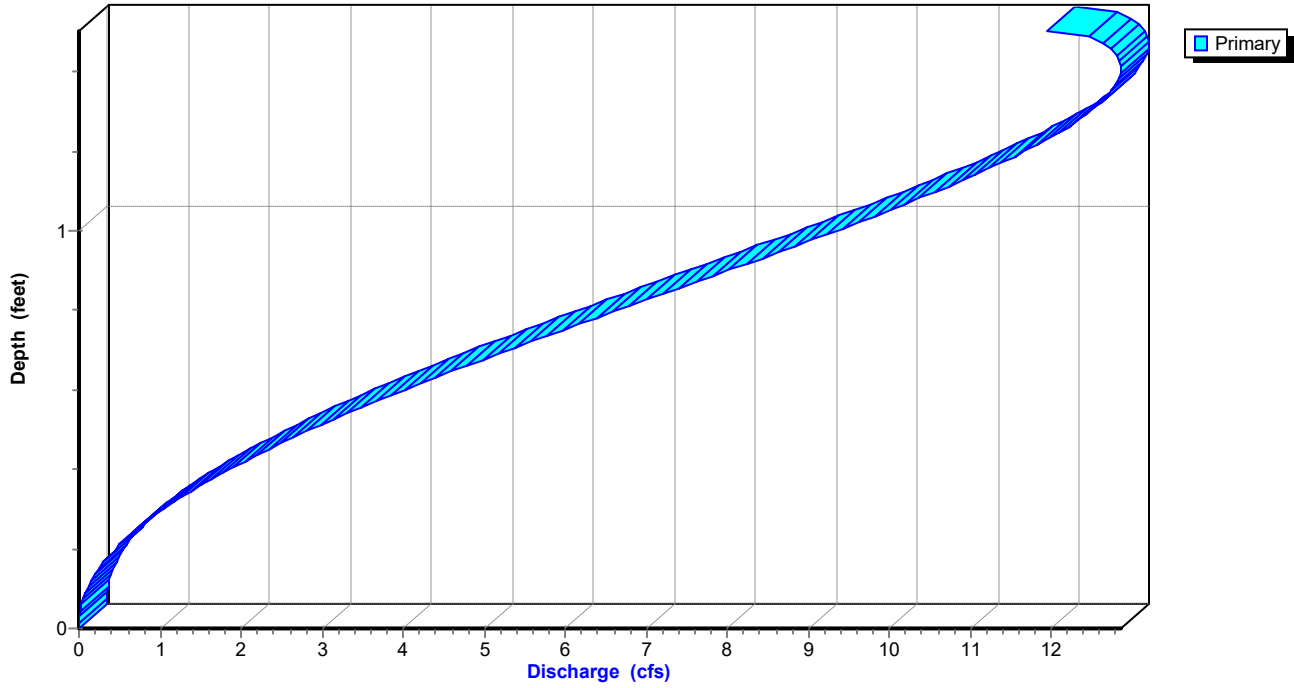

Summerwood Gym 3*AR - Little Rock 100-yr Duration=10 min, Inten=7.98 in/hr*

Prepared by Phillip Lewis Engineering

Printed 1/11/2024

HydroCAD® 10.20-2f s/n 12520 © 2022 HydroCAD Software Solutions LLC

Stage-Area-Storage for Reach P-A2: Pipe A2

Elevation (feet)	End-Area (sq-ft)	Storage (cubic-feet)	Elevation (feet)	End-Area (sq-ft)	Storage (cubic-feet)
406.85	0.0	0	407.89	1.3	231
406.87	0.0	1	407.91	1.3	236
406.89	0.0	2	407.93	1.4	241
406.91	0.0	4	407.95	1.4	246
406.93	0.0	6	407.97	1.4	250
406.95	0.1	9	407.99	1.4	255
406.97	0.1	12	408.01	1.5	260
406.99	0.1	15	408.03	1.5	264
407.01	0.1	18	408.05	1.5	268
407.03	0.1	21	408.07	1.5	272
407.05	0.1	25	408.09	1.6	277
407.07	0.2	28	408.11	1.6	280
407.09	0.2	32	408.13	1.6	284
407.11	0.2	36	408.15	1.6	288
407.13	0.2	40	408.17	1.6	292
407.15	0.3	45	408.19	1.7	295
407.17	0.3	49	408.21	1.7	298
407.19	0.3	53	408.23	1.7	301
407.21	0.3	58	408.25	1.7	304
407.23	0.4	62	408.27	1.7	306
407.25	0.4	67	408.29	1.7	309
407.27	0.4	72	408.31	1.8	310
407.29	0.4	76	408.33	1.8	312
407.31	0.5	81	408.35	1.8	313
407.33	0.5	86			
407.35	0.5	91			
407.37	0.5	96			
407.39	0.6	101			
407.41	0.6	106			
407.43	0.6	112			
407.45	0.7	117			
407.47	0.7	122			
407.49	0.7	127			
407.51	0.7	133			
407.53	0.8	138			
407.55	0.8	143			
407.57	0.8	148			
407.59	0.9	154			
407.61	0.9	159			
407.63	0.9	164			
407.65	1.0	170			
407.67	1.0	175			
407.69	1.0	180			
407.71	1.0	185			
407.73	1.1	191			
407.75	1.1	196			
407.77	1.1	201			
407.79	1.2	206			
407.81	1.2	211			
407.83	1.2	216			
407.85	1.3	222			
407.87	1.3	226			

Summerwood Gym 3

AR - Little Rock 100-yr Duration=10 min, Inten=7.98 in/hr

Prepared by Phillip Lewis Engineering

Printed 1/11/2024

HydroCAD® 10.20-2f s/n 12520 © 2022 HydroCAD Software Solutions LLC

Summary for Reach P-A3: Pipe A3

Inflow Area = 71,768 sf, 58.28% Impervious, Inflow Depth = 0.97" for 100-yr event
Inflow = 9.59 cfs @ 0.17 hrs, Volume= 5,787 cf
Outflow = 9.53 cfs @ 0.17 hrs, Volume= 5,787 cf, Atten= 1%, Lag= 0.2 min
Routed to Reach P-A4 : Pipe A4

Routing by Stor-Ind+Trans method, Time Span= 0.00-3.00 hrs, dt= 0.01 hrs
Max. Velocity= 10.19 fps, Min. Travel Time= 0.2 min
Avg. Velocity = 4.21 fps, Avg. Travel Time= 0.5 min

Peak Storage= 111 cf @ 0.17 hrs
Average Depth at Peak Storage= 0.79' , Surface Width= 1.50'
Bank-Full Depth= 1.50' Flow Area= 1.8 sf, Capacity= 17.65 cfs

18.0" Round Pipe
n= 0.013 Corrugated PE, smooth interior
Length= 118.0' Slope= 0.0282 '/'
Inlet Invert= 404.46', Outlet Invert= 401.13'

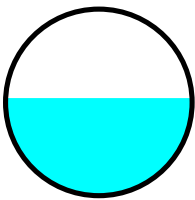

Reach P-A3: Pipe A3

Hydrograph

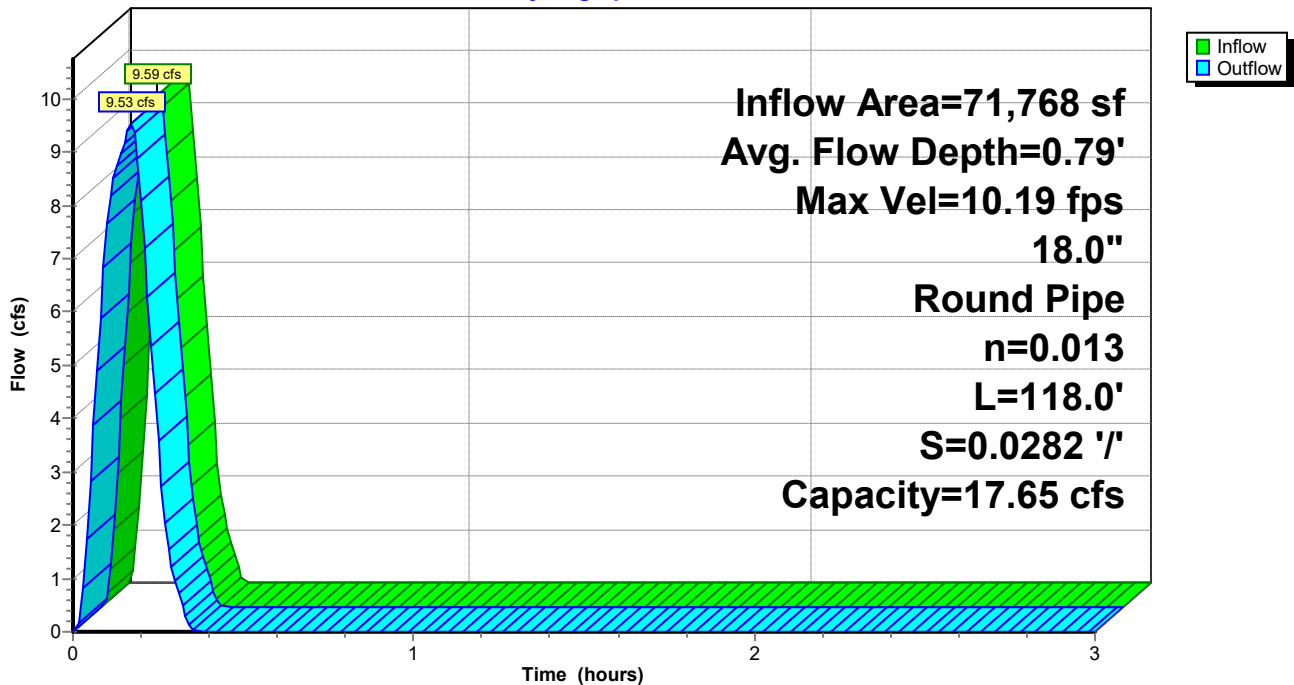

Reach P-A3: Pipe A3

Stage-Discharge

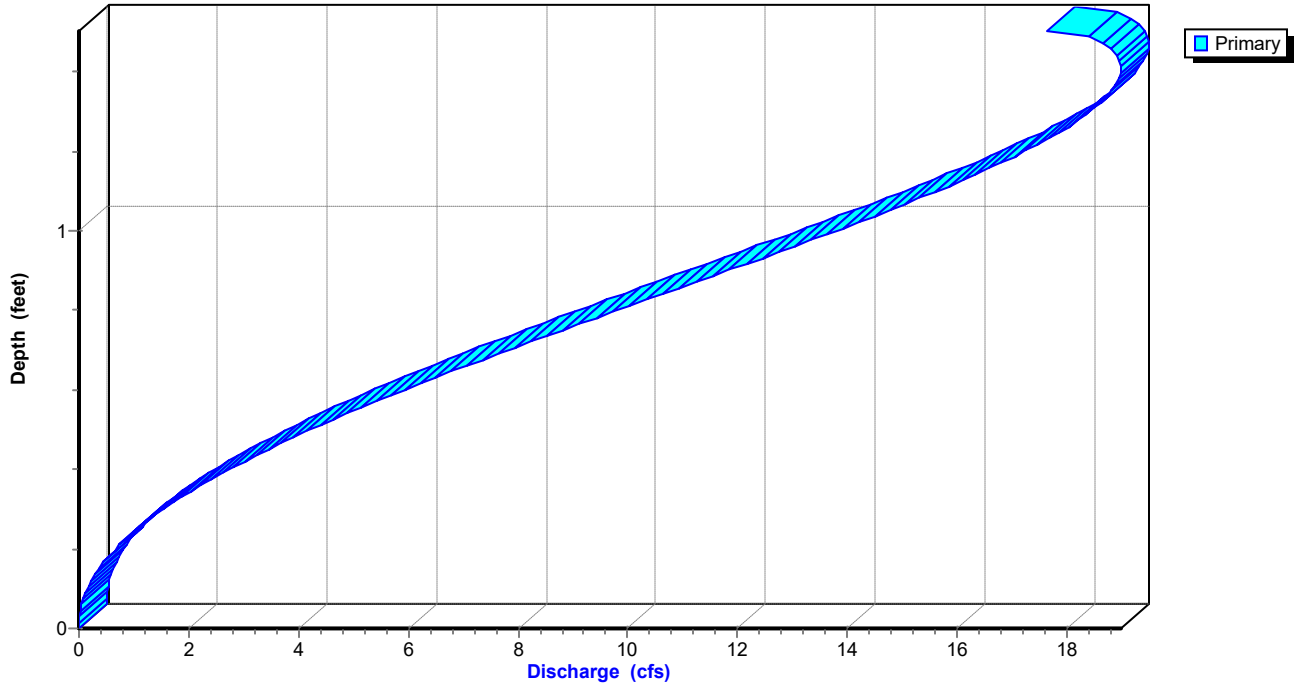

Summerwood Gym 3*AR - Little Rock 100-yr Duration=10 min, Inten=7.98 in/hr*

Prepared by Phillip Lewis Engineering

Printed 1/11/2024

HydroCAD® 10.20-2f s/n 12520 © 2022 HydroCAD Software Solutions LLC

Stage-Area-Storage for Reach P-A3: Pipe A3

Elevation (feet)	End-Area (sq-ft)	Storage (cubic-feet)	Elevation (feet)	End-Area (sq-ft)	Storage (cubic-feet)
404.46	0.0	0	405.50	1.3	154
404.48	0.0	1	405.52	1.3	158
404.50	0.0	2	405.54	1.4	161
404.52	0.0	3	405.56	1.4	164
404.54	0.0	4	405.58	1.4	167
404.56	0.1	6	405.60	1.4	170
404.58	0.1	8	405.62	1.5	173
404.60	0.1	10	405.64	1.5	176
404.62	0.1	12	405.66	1.5	179
404.64	0.1	14	405.68	1.5	182
404.66	0.1	17	405.70	1.6	184
404.68	0.2	19	405.72	1.6	187
404.70	0.2	22	405.74	1.6	190
404.72	0.2	24	405.76	1.6	192
404.74	0.2	27	405.78	1.6	194
404.76	0.3	30	405.80	1.7	197
404.78	0.3	33	405.82	1.7	199
404.80	0.3	35	405.84	1.7	201
404.82	0.3	38	405.86	1.7	203
404.84	0.4	42	405.88	1.7	204
404.86	0.4	45	405.90	1.7	206
404.88	0.4	48	405.92	1.8	207
404.90	0.4	51	405.94	1.8	208
404.92	0.5	54	405.96	1.8	209
404.94	0.5	58			
404.96	0.5	61			
404.98	0.5	64			
405.00	0.6	68			
405.02	0.6	71			
405.04	0.6	74			
405.06	0.7	78			
405.08	0.7	81			
405.10	0.7	85			
405.12	0.7	88			
405.14	0.8	92			
405.16	0.8	95			
405.18	0.8	99			
405.20	0.9	102			
405.22	0.9	106			
405.24	0.9	110			
405.26	1.0	113			
405.28	1.0	117			
405.30	1.0	120			
405.32	1.0	124			
405.34	1.1	127			
405.36	1.1	131			
405.38	1.1	134			
405.40	1.2	138			
405.42	1.2	141			
405.44	1.2	144			
405.46	1.3	148			
405.48	1.3	151			

Summerwood Gym 3

AR - Little Rock 100-yr Duration=10 min, Inten=7.98 in/hr

Prepared by Phillip Lewis Engineering

Printed 1/11/2024

HydroCAD® 10.20-2f s/n 12520 © 2022 HydroCAD Software Solutions LLC

Summary for Reach P-A4: Pipe A4

Inflow Area = 71,768 sf, 58.28% Impervious, Inflow Depth = 0.97" for 100-yr event
Inflow = 9.53 cfs @ 0.17 hrs, Volume= 5,787 cf
Outflow = 9.49 cfs @ 0.18 hrs, Volume= 5,787 cf, Atten= 0%, Lag= 0.4 min
Routed to Pond DP1 : Re-Established East Pond

Routing by Stor-Ind+Trans method, Time Span= 0.00-3.00 hrs, dt= 0.01 hrs
Max. Velocity= 10.17 fps, Min. Travel Time= 0.2 min
Avg. Velocity = 4.00 fps, Avg. Travel Time= 0.6 min

Peak Storage= 123 cf @ 0.17 hrs
Average Depth at Peak Storage= 0.78' , Surface Width= 1.50'
Bank-Full Depth= 1.50' Flow Area= 1.8 sf, Capacity= 17.66 cfs

18.0" Round Pipe
n= 0.013 Corrugated PE, smooth interior
Length= 132.0' Slope= 0.0283 '/'
Inlet Invert= 401.03', Outlet Invert= 397.30'

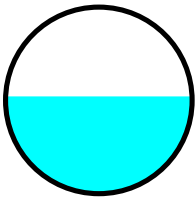

Reach P-A4: Pipe A4

Hydrograph

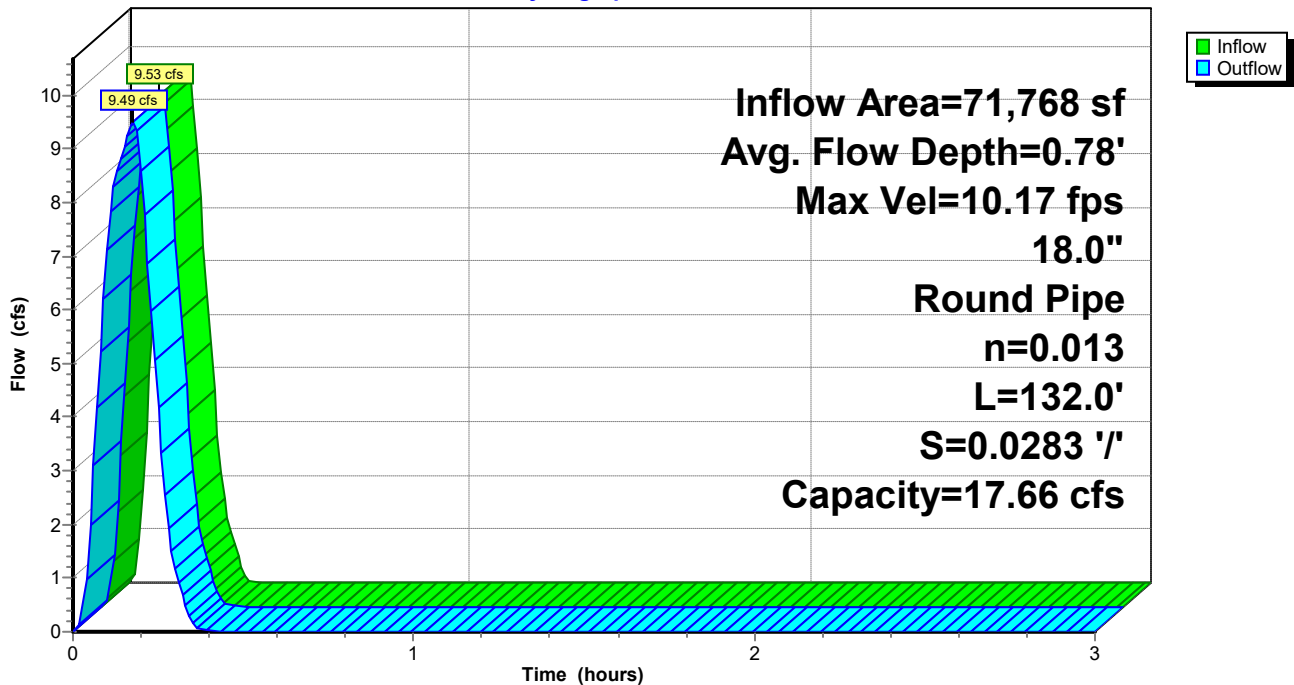

Reach P-A4: Pipe A4

Stage-Discharge

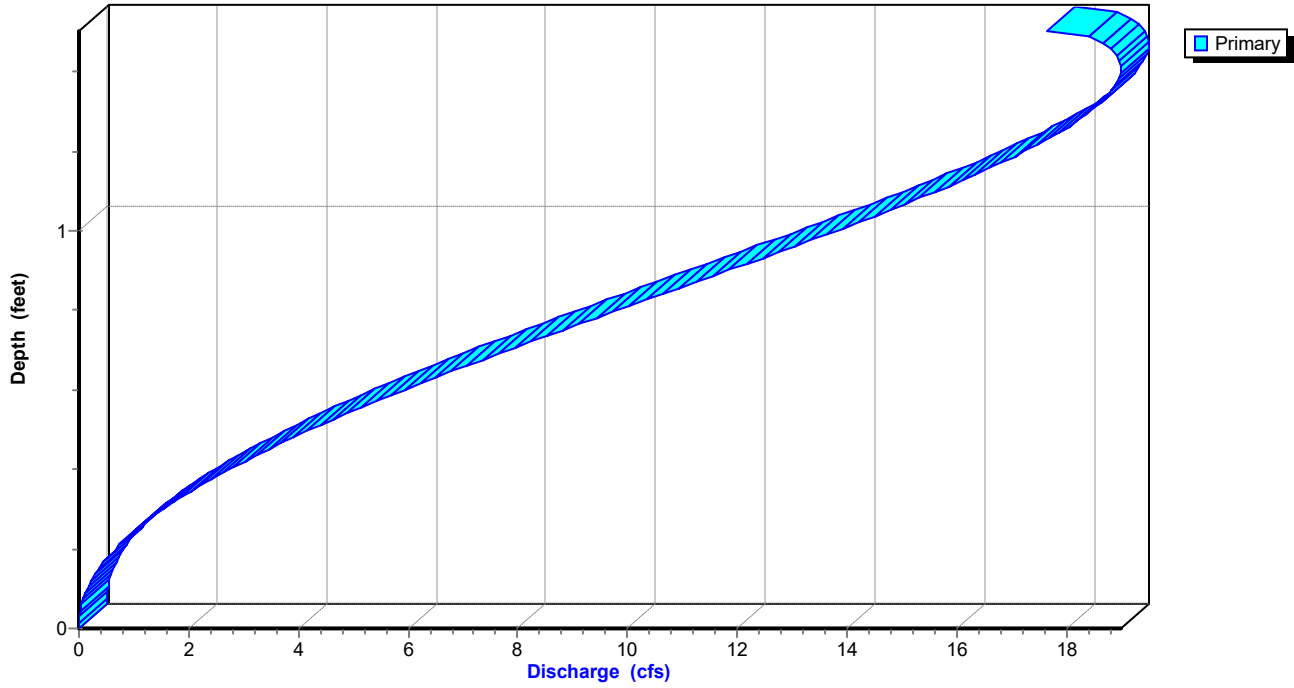

Summerwood Gym 3*AR - Little Rock 100-yr Duration=10 min, Inten=7.98 in/hr*

Prepared by Phillip Lewis Engineering

Printed 1/11/2024

HydroCAD® 10.20-2f s/n 12520 © 2022 HydroCAD Software Solutions LLC

Stage-Area-Storage for Reach P-A4: Pipe A4

Elevation (feet)	End-Area (sq-ft)	Storage (cubic-feet)	Elevation (feet)	End-Area (sq-ft)	Storage (cubic-feet)
401.03	0.0	0	402.07	1.3	173
401.05	0.0	1	402.09	1.3	176
401.07	0.0	2	402.11	1.4	180
401.09	0.0	3	402.13	1.4	183
401.11	0.0	5	402.15	1.4	187
401.13	0.1	7	402.17	1.4	190
401.15	0.1	9	402.19	1.5	194
401.17	0.1	11	402.21	1.5	197
401.19	0.1	13	402.23	1.5	200
401.21	0.1	16	402.25	1.5	203
401.23	0.1	18	402.27	1.6	206
401.25	0.2	21	402.29	1.6	209
401.27	0.2	24	402.31	1.6	212
401.29	0.2	27	402.33	1.6	215
401.31	0.2	30	402.35	1.6	217
401.33	0.3	33	402.37	1.7	220
401.35	0.3	36	402.39	1.7	222
401.37	0.3	40	402.41	1.7	225
401.39	0.3	43	402.43	1.7	227
401.41	0.4	46	402.45	1.7	228
401.43	0.4	50	402.47	1.7	230
401.45	0.4	53	402.49	1.8	232
401.47	0.4	57	402.51	1.8	233
401.49	0.5	61	402.53	1.8	233
401.51	0.5	64			
401.53	0.5	68			
401.55	0.5	72			
401.57	0.6	76			
401.59	0.6	79			
401.61	0.6	83			
401.63	0.7	87			
401.65	0.7	91			
401.67	0.7	95			
401.69	0.7	99			
401.71	0.8	103			
401.73	0.8	107			
401.75	0.8	111			
401.77	0.9	115			
401.79	0.9	119			
401.81	0.9	123			
401.83	1.0	127			
401.85	1.0	130			
401.87	1.0	134			
401.89	1.0	138			
401.91	1.1	142			
401.93	1.1	146			
401.95	1.1	150			
401.97	1.2	154			
401.99	1.2	158			
402.01	1.2	161			
402.03	1.3	165			
402.05	1.3	169			

Summerwood Gym 3

AR - Little Rock 100-yr Duration=10 min, Inten=7.98 in/hr

Prepared by Phillip Lewis Engineering

Printed 1/11/2024

HydroCAD® 10.20-2f s/n 12520 © 2022 HydroCAD Software Solutions LLC

Summary for Pond DP1: Re-Established East Pond

Inflow Area = 132,514 sf, 61.41% Impervious, Inflow Depth = 0.99" for 100-yr event
Inflow = 17.76 cfs @ 0.16 hrs, Volume= 10,883 cf
Outflow = 9.14 cfs @ 0.22 hrs, Volume= 10,883 cf, Atten= 49%, Lag= 3.8 min
Primary = 9.14 cfs @ 0.22 hrs, Volume= 10,883 cf
Routed to Link Post-Dev : APPROX DISCHARGE

Routing by Stor-Ind method, Time Span= 0.00-3.00 hrs, dt= 0.01 hrs
Peak Elev= 398.89' @ 0.22 hrs Storage= 5,867 cf

Plug-Flow detention time= 9.3 min calculated for 10,883 cf (100% of inflow)
Center-of-Mass det. time= 9.1 min (18.0 - 8.8)

Volume	Invert	Avail.Storage	Storage Description
#1	396.00'	8,557 cf	Custom Stage Data Listed below

Elevation (feet)	Inc.Store (cubic-feet)	Cum.Store (cubic-feet)
396.00	0	0
396.50	250	250
397.00	1,092	1,342
398.00	2,387	3,729
399.00	2,405	6,134
400.00	2,423	8,557

Device	Routing	Invert	Outlet Devices
#1	Primary	399.00'	5.0' long Sharp-Crested Rectangular Weir 2 End Contraction(s)
#2	Primary	396.00'	1.1' long Sharp-Crested Rectangular Weir 2 End Contraction(s) 10.0' Crest Height

Primary OutFlow Max=9.13 cfs @ 0.22 hrs HW=398.89' (Free Discharge)

1=Sharp-Crested Rectangular Weir (Controls 0.00 cfs)

2=Sharp-Crested Rectangular Weir (Weir Controls 9.13 cfs @ 5.75 fps)

Summerwood Gym 3

Prepared by Phillip Lewis Engineering

HydroCAD® 10.20-2f s/n 12520 © 2022 HydroCAD Software Solutions LLC

AR - Little Rock 100-yr Duration=10 min, Inten=7.98 in/hr

Printed 1/11/2024

Pond DP1: Re-Established East Pond

Hydrograph

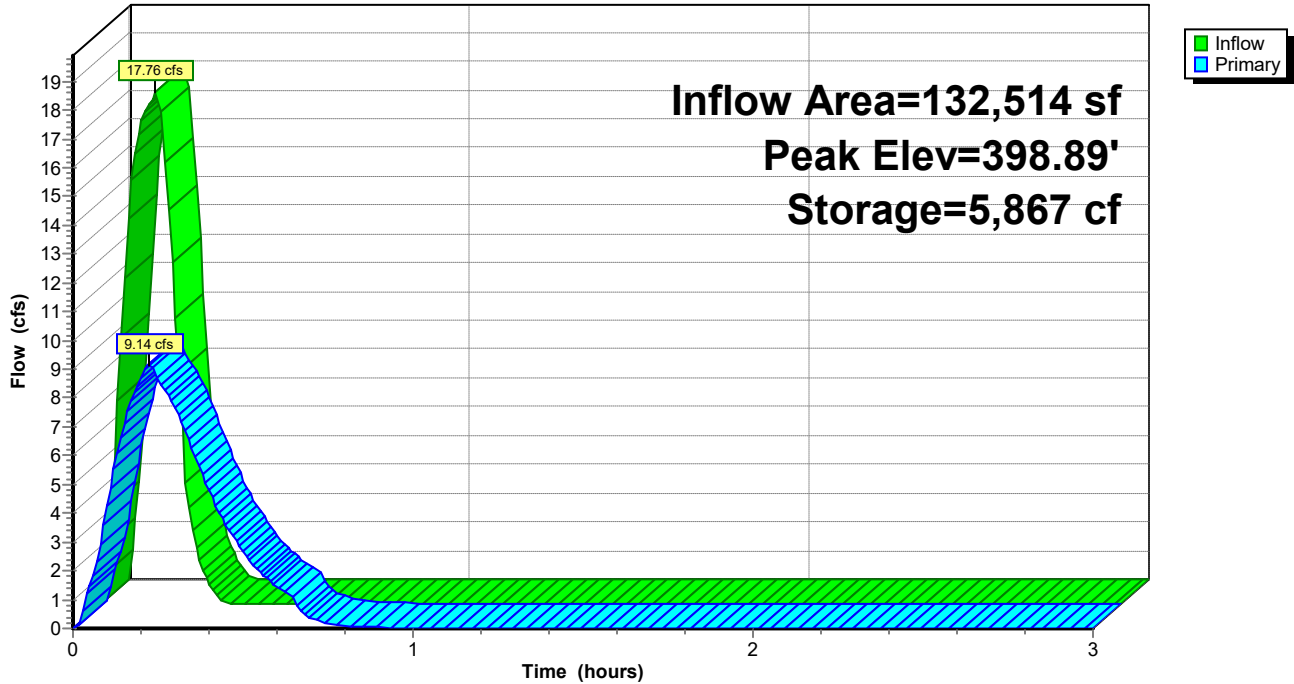

Pond DP1: Re-Established East Pond

Stage-Discharge

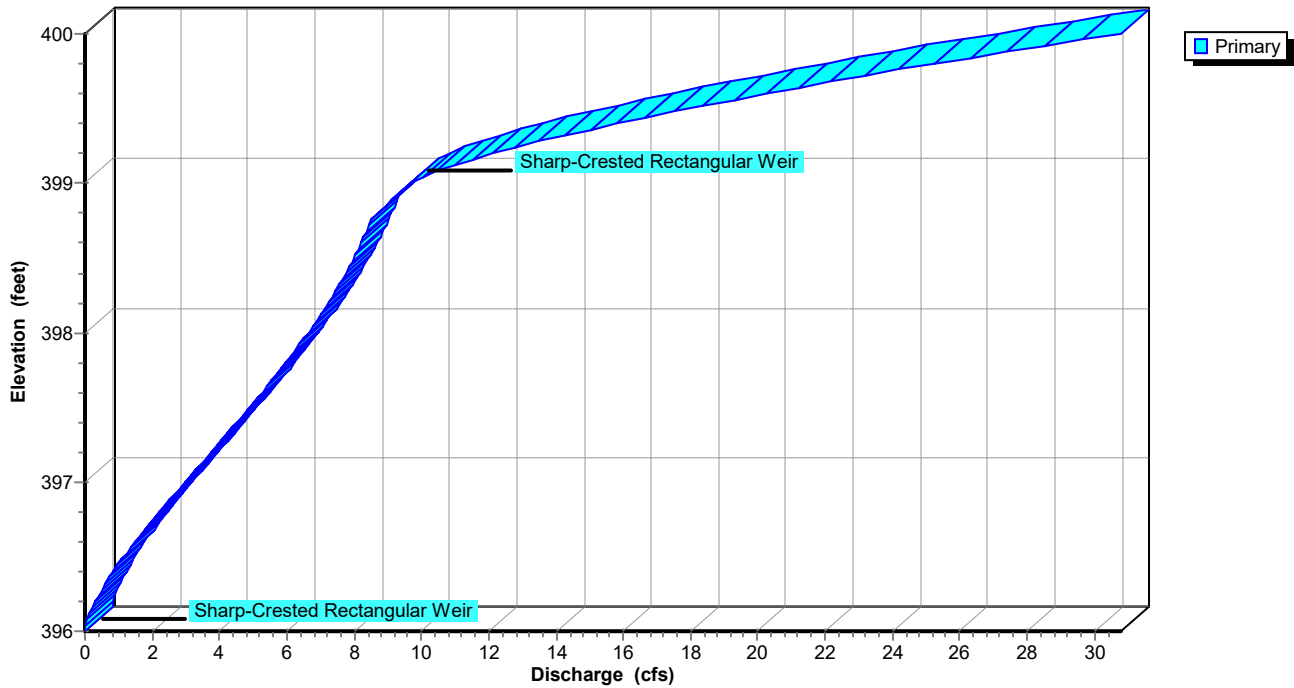

Summerwood Gym 3

AR - Little Rock 100-yr Duration=10 min, Inten=7.98 in/hr

Prepared by Phillip Lewis Engineering

Printed 1/11/2024

HydroCAD® 10.20-2f s/n 12520 © 2022 HydroCAD Software Solutions LLC

Stage-Area-Storage for Pond DP1: Re-Established East Pond

Elevation (feet)	Storage (cubic-feet)	Elevation (feet)	Storage (cubic-feet)
396.00	0	398.60	5,172
396.05	25	398.65	5,292
396.10	50	398.70	5,412
396.15	75	398.75	5,533
396.20	100	398.80	5,653
396.25	125	398.85	5,773
396.30	150	398.90	5,893
396.35	175	398.95	6,014
396.40	200	399.00	6,134
396.45	225	399.05	6,255
396.50	250	399.10	6,376
396.55	359	399.15	6,497
396.60	468	399.20	6,619
396.65	578	399.25	6,740
396.70	687	399.30	6,861
396.75	796	399.35	6,982
396.80	905	399.40	7,103
396.85	1,014	399.45	7,224
396.90	1,124	399.50	7,346
396.95	1,233	399.55	7,467
397.00	1,342	399.60	7,588
397.05	1,461	399.65	7,709
397.10	1,581	399.70	7,830
397.15	1,700	399.75	7,951
397.20	1,819	399.80	8,072
397.25	1,939	399.85	8,194
397.30	2,058	399.90	8,315
397.35	2,177	399.95	8,436
397.40	2,297	400.00	8,557
397.45	2,416		
397.50	2,536		
397.55	2,655		
397.60	2,774		
397.65	2,894		
397.70	3,013		
397.75	3,132		
397.80	3,252		
397.85	3,371		
397.90	3,490		
397.95	3,610		
398.00	3,729		
398.05	3,849		
398.10	3,970		
398.15	4,090		
398.20	4,210		
398.25	4,330		
398.30	4,451		
398.35	4,571		
398.40	4,691		
398.45	4,811		
398.50	4,932		
398.55	5,052		

Summerwood Gym 3

AR - Little Rock 100-yr Duration=10 min, Inten=7.98 in/hr

Prepared by Phillip Lewis Engineering

Printed 1/11/2024

HydroCAD® 10.20-2f s/n 12520 © 2022 HydroCAD Software Solutions LLC

Summary for Link Post-Dev: APPROX DISCHARGE

Inflow Area = 206,166 sf, 64.42% Impervious, Inflow Depth = 1.01" for 100-yr event
Inflow = 18.25 cfs @ 0.16 hrs, Volume= 17,276 cf
Primary = 18.25 cfs @ 0.16 hrs, Volume= 17,276 cf, Atten= 0%, Lag= 0.0 min

Primary outflow = Inflow, Time Span= 0.00-3.00 hrs, dt= 0.01 hrs

Link Post-Dev: APPROX DISCHARGE

Hydrograph

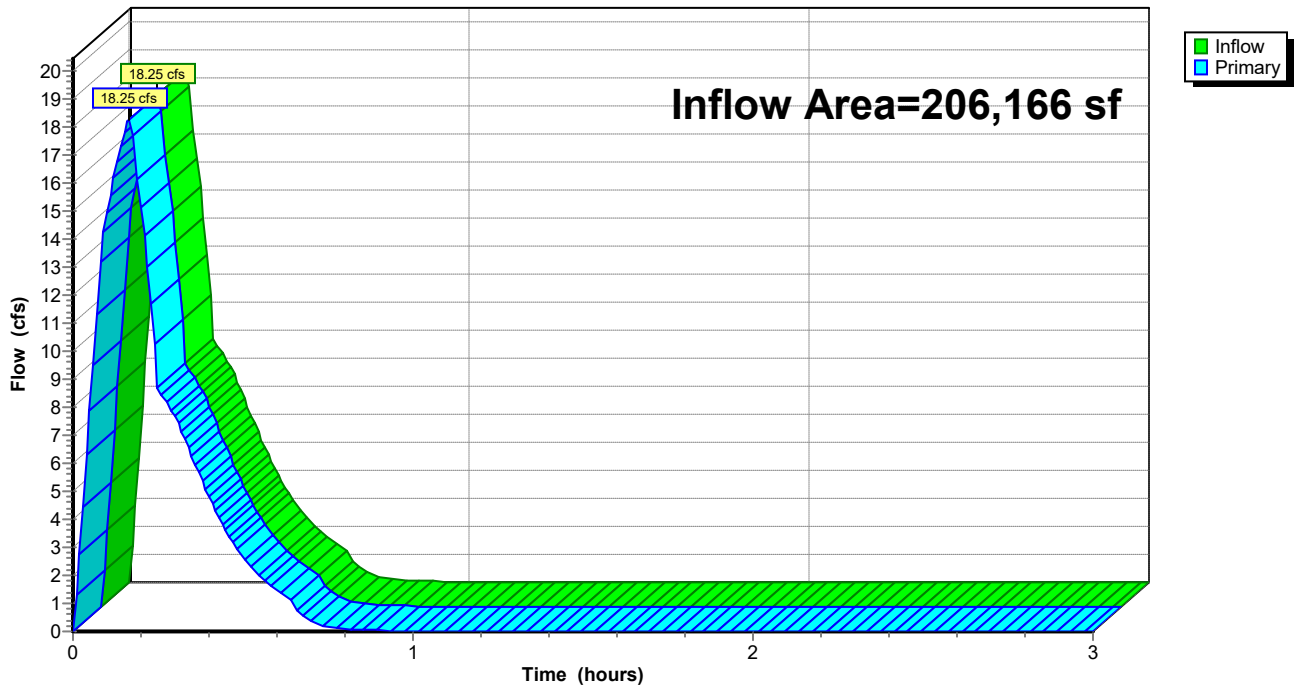

STROM SEWER SIZING

Inlet Report

AI-A2

Drop Grate Inlet

Location	= Sag
Curb Length (ft)	= -0-
Throat Height (in)	= -0-
Grate Area (sqft)	= 2.00
Grate Width (ft)	= 2.00
Grate Length (ft)	= 2.00

Gutter

Slope, Sw (ft/ft)	= 0.050
Slope, Sx (ft/ft)	= 0.050
Local Depr (in)	= -0-
Gutter Width (ft)	= 2.00
Gutter Slope (%)	= -0-
Gutter n-value	= -0-

Calculations

Compute by:	Known Q
Q (cfs)	= 2.16

Highlighted

Q Total (cfs)	= 2.16
Q Capt (cfs)	= 2.16
Q Bypass (cfs)	= -0-
Depth at Inlet (in)	= 2.41
Efficiency (%)	= 100
Gutter Spread (ft)	= 10.03
Gutter Vel (ft/s)	= -0-
Bypass Spread (ft)	= -0-
Bypass Depth (in)	= -0-

All dimensions in feet

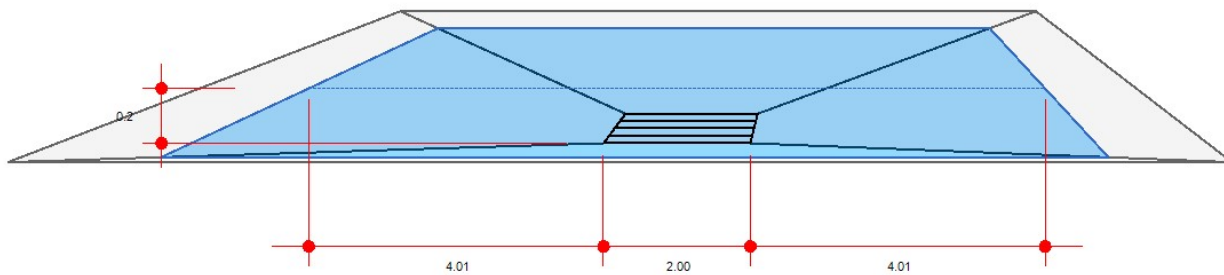

Inlet Report

AI-A3

Drop Grate Inlet

Location	= Sag
Curb Length (ft)	= -0-
Throat Height (in)	= -0-
Grate Area (sqft)	= 2.00
Grate Width (ft)	= 2.00
Grate Length (ft)	= 2.00

Gutter

Slope, Sw (ft/ft)	= 0.050
Slope, Sx (ft/ft)	= 0.050
Local Depr (in)	= -0-
Gutter Width (ft)	= 2.00
Gutter Slope (%)	= -0-
Gutter n-value	= -0-

Calculations

Compute by:	Known Q
Q (cfs)	= 2.99

Highlighted

Q Total (cfs)	= 2.99
Q Capt (cfs)	= 2.99
Q Bypass (cfs)	= -0-
Depth at Inlet (in)	= 2.99
Efficiency (%)	= 100
Gutter Spread (ft)	= 11.97
Gutter Vel (ft/s)	= -0-
Bypass Spread (ft)	= -0-
Bypass Depth (in)	= -0-

All dimensions in feet

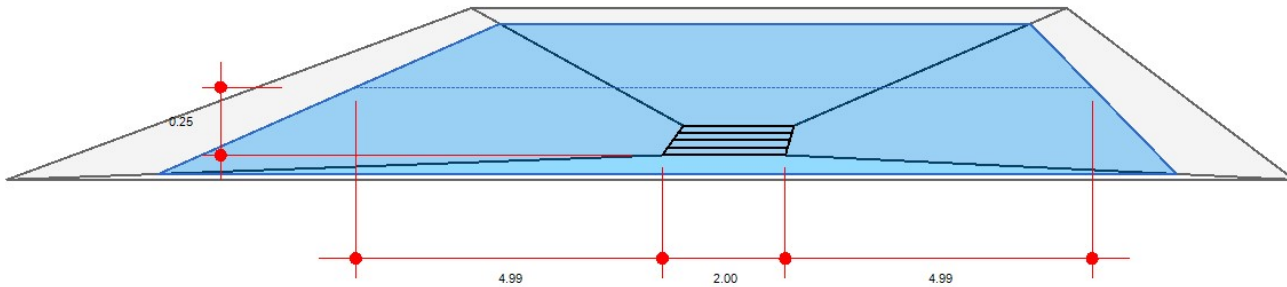

Channel Report

Pipe A1

Circular

Diameter (ft) = 1.50

Invert Elev (ft) = 408.33

Slope (%) = 2.70

N-Value = 0.015

Calculations

Compute by: Known Q

Known Q (cfs) = 2.92

Highlighted

Depth (ft) = 0.45

Q (cfs) = 2.920

Area (sqft) = 0.45

Velocity (ft/s) = 6.54

Wetted Perim (ft) = 1.74

Crit Depth, Yc (ft) = 0.65

Top Width (ft) = 1.38

EGL (ft) = 1.11

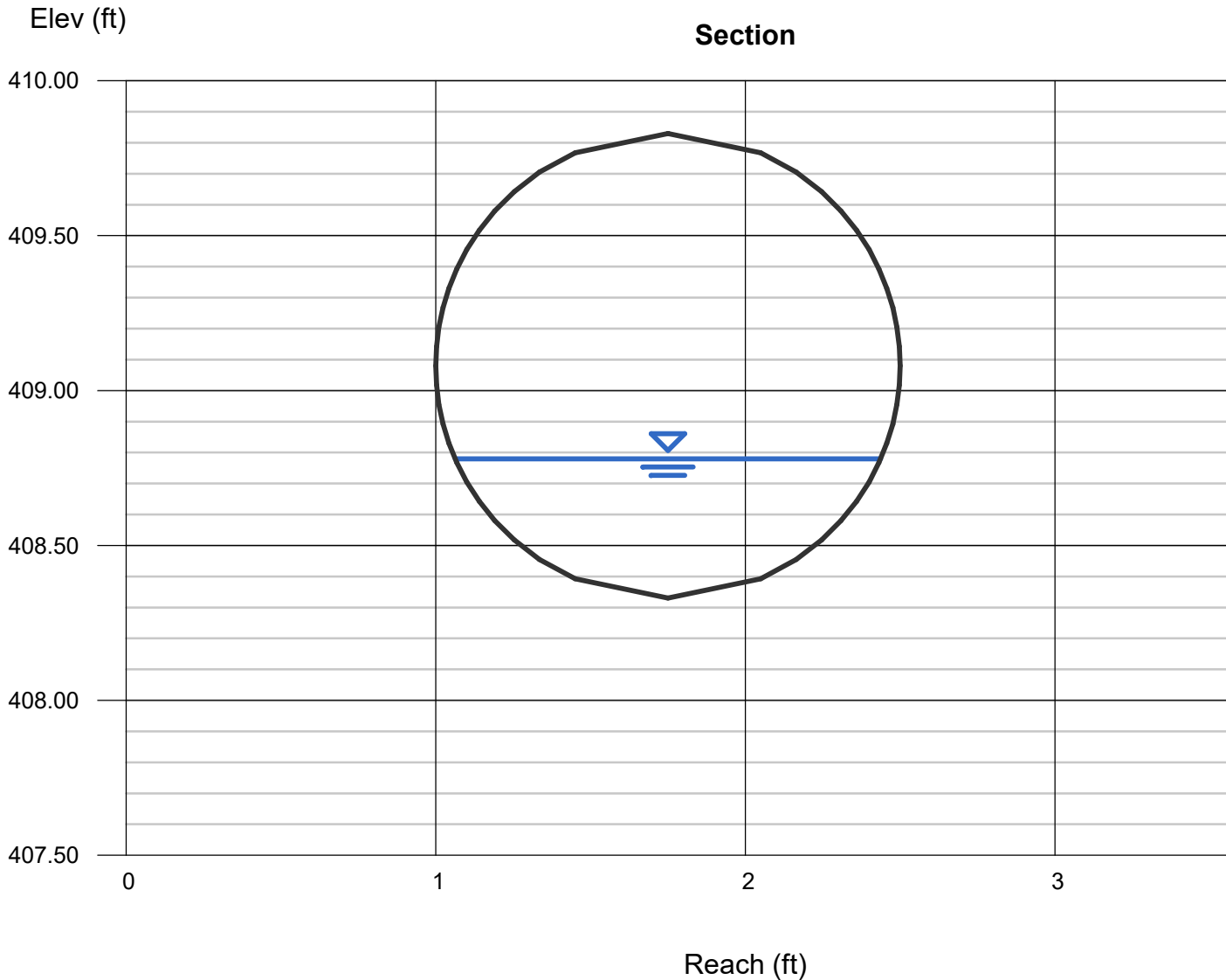

Channel Report

Pipe A2

Circular

Diameter (ft) = 1.50

Invert Elev (ft) = 406.85

Slope (%) = 1.30

N-Value = 0.015

Calculations

Compute by: Known Q

Known Q (cfs) = 5.09

Highlighted

Depth (ft) = 0.74

Q (cfs) = 5.090

Area (sqft) = 0.87

Velocity (ft/s) = 5.84

Wetted Perim (ft) = 2.34

Crit Depth, Y_c (ft) = 0.87

Top Width (ft) = 1.50

EGL (ft) = 1.27

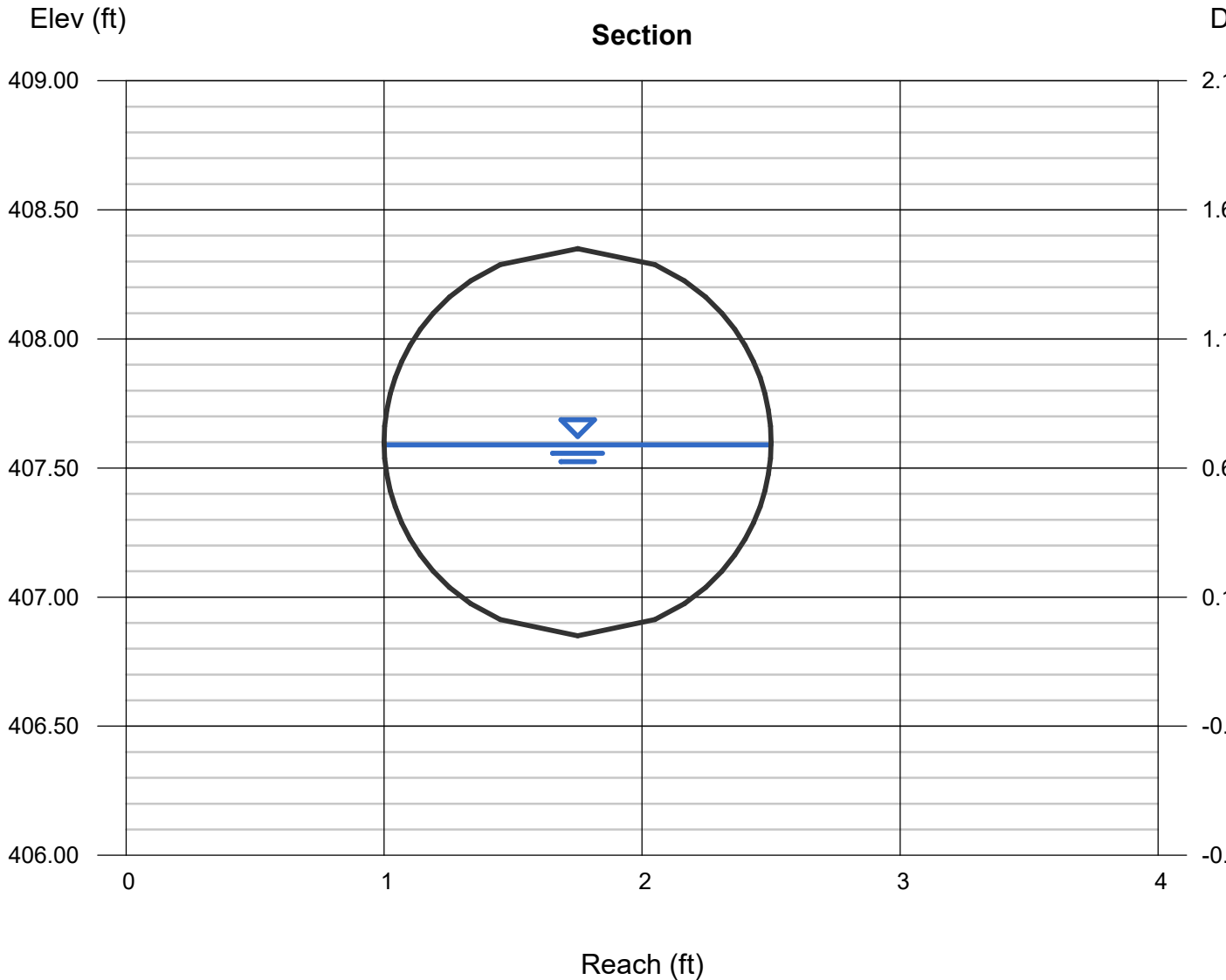

Channel Report

Pipe A3

Circular

Diameter (ft) = 1.50

Invert Elev (ft) = 404.46

Slope (%) = 2.80

N-Value = 0.015

Calculations

Compute by: Known Q

Known Q (cfs) = 8.02

Highlighted

Depth (ft) = 0.78

Q (cfs) = 8.020

Area (sqft) = 0.93

Velocity (ft/s) = 8.59

Wetted Perim (ft) = 2.42

Crit Depth, Y_c (ft) = 1.10

Top Width (ft) = 1.50

EGL (ft) = 1.93

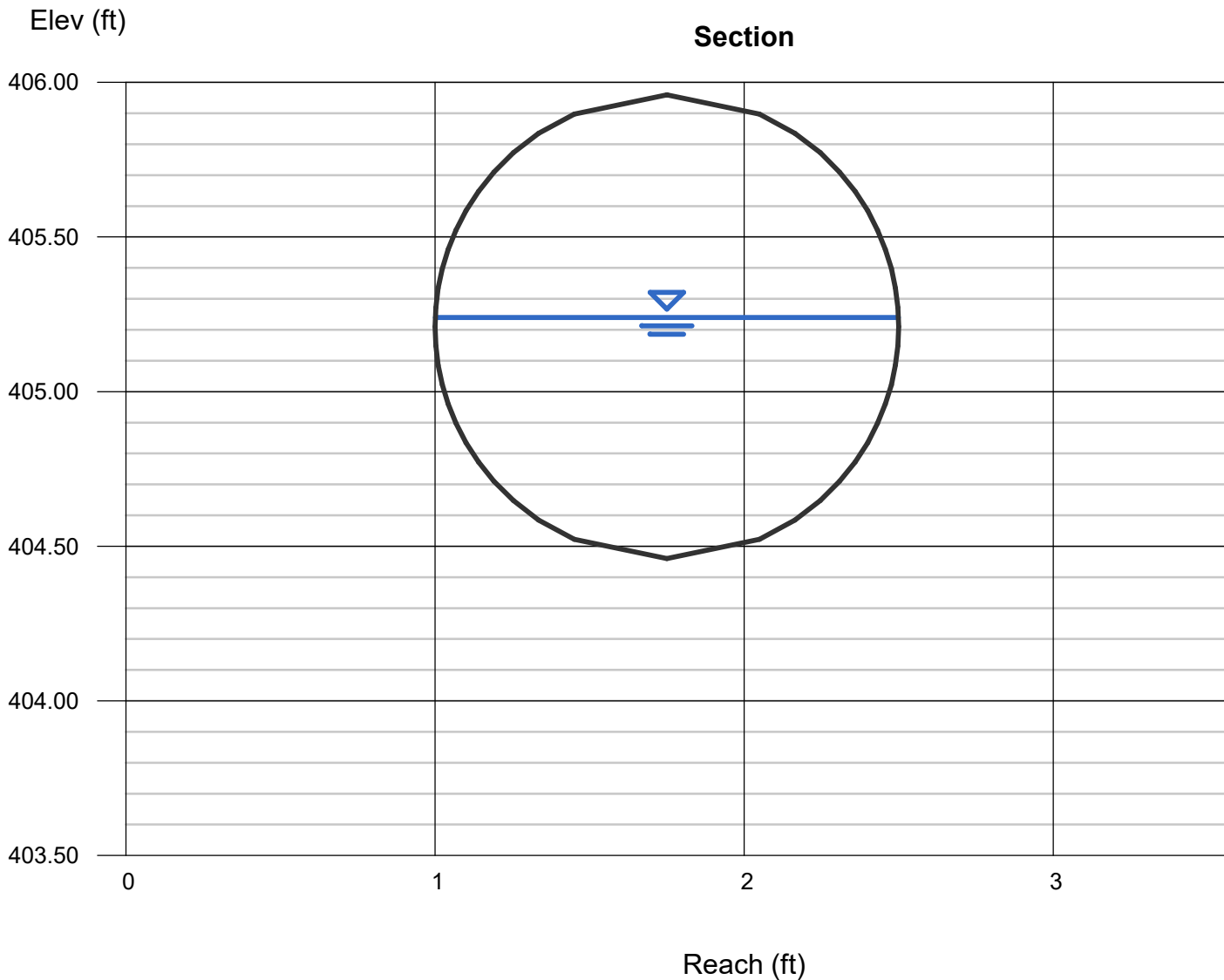

Channel Report

Pipe A4

Circular

Diameter (ft) = 1.50

Invert Elev (ft) = 401.03

Slope (%) = 2.83

N-Value = 0.013

Calculations

Compute by: Known Q

Known Q (cfs) = 8.02

Highlighted

Depth (ft) = 0.71

Q (cfs) = 8.020

Area (sqft) = 0.83

Velocity (ft/s) = 9.70

Wetted Perim (ft) = 2.28

Crit Depth, Y_c (ft) = 1.10

Top Width (ft) = 1.50

EGL (ft) = 2.17

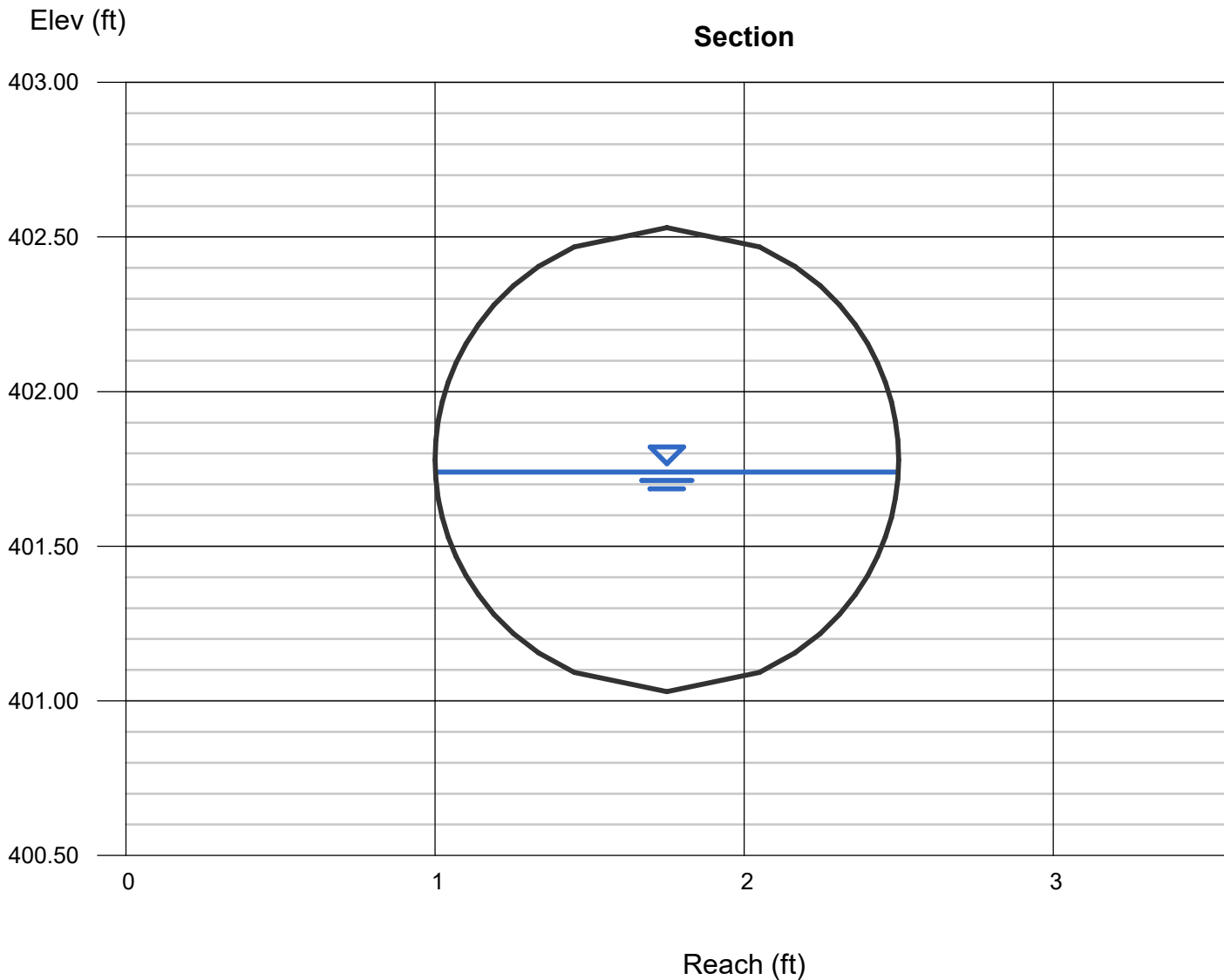

Channel Report

5' Curb Cut & Flume to Pond

Rectangular

Bottom Width (ft) = 5.00

Total Depth (ft) = 0.50

Invert Elev (ft) = 401.50

Slope (%) = 15.00

N-Value = 0.015

Calculations

Compute by: Known Q

Known Q (cfs) = 5.15

Highlighted

Depth (ft) = 0.12

Q (cfs) = 5.150

Area (sqft) = 0.60

Velocity (ft/s) = 8.58

Wetted Perim (ft) = 5.24

Crit Depth, Y_c (ft) = 0.33

Top Width (ft) = 5.00

EGL (ft) = 1.27

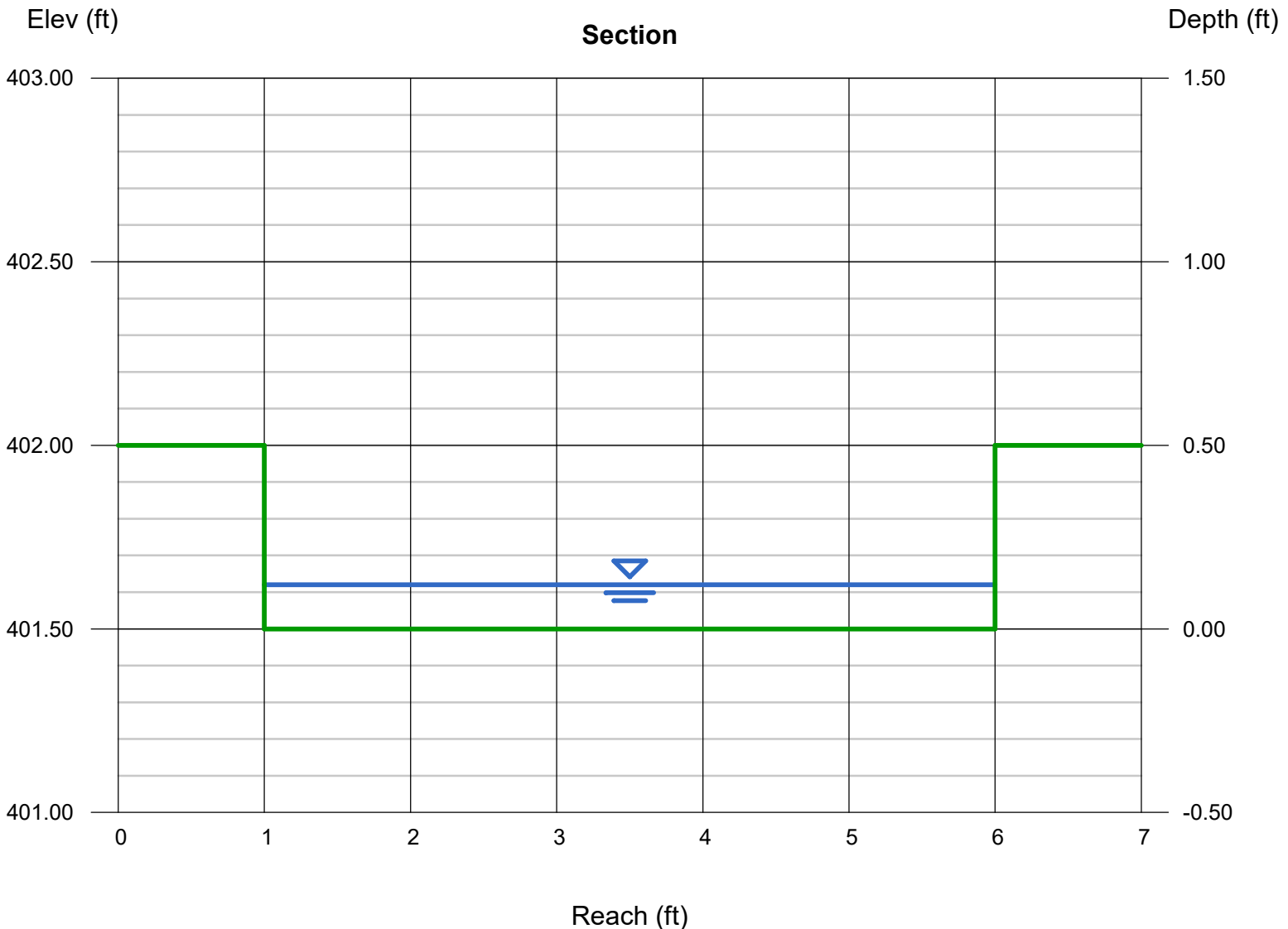

Channel Report

Curb Cut by Dumpster Pad

Rectangular

Bottom Width (ft) = 4.00
Total Depth (ft) = 0.50

Invert Elev (ft) = 409.13
Slope (%) = 5.00
N-Value = 0.015

Calculations

Compute by: Known Q
Known Q (cfs) = 8.18

Highlighted

Depth (ft) = 0.26
Q (cfs) = 8.180
Area (sqft) = 1.04
Velocity (ft/s) = 7.87
Wetted Perim (ft) = 4.52
Crit Depth, Yc (ft) = 0.50
Top Width (ft) = 4.00
EGL (ft) = 1.22

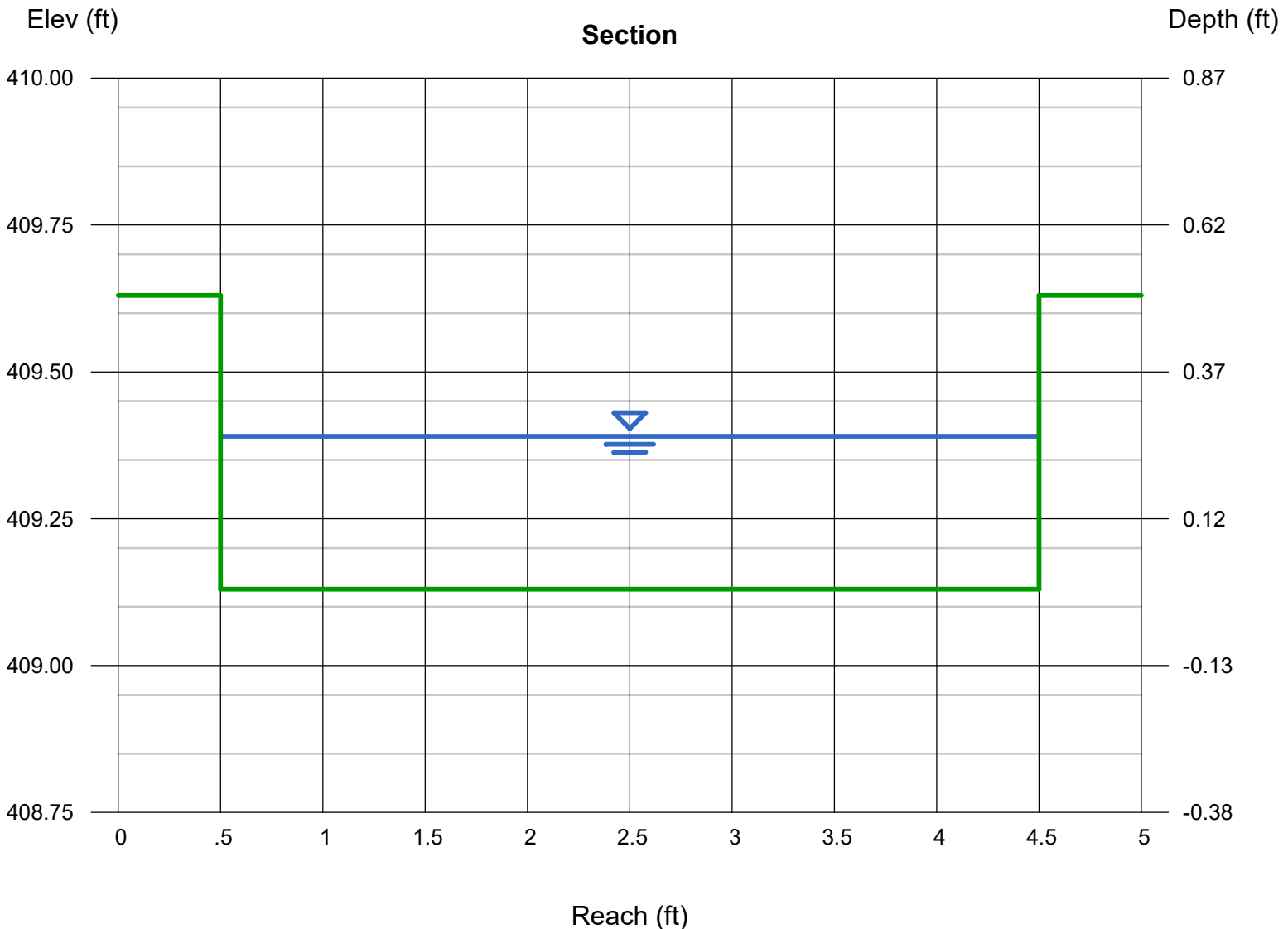

DRAINAGE BASIN MAPS

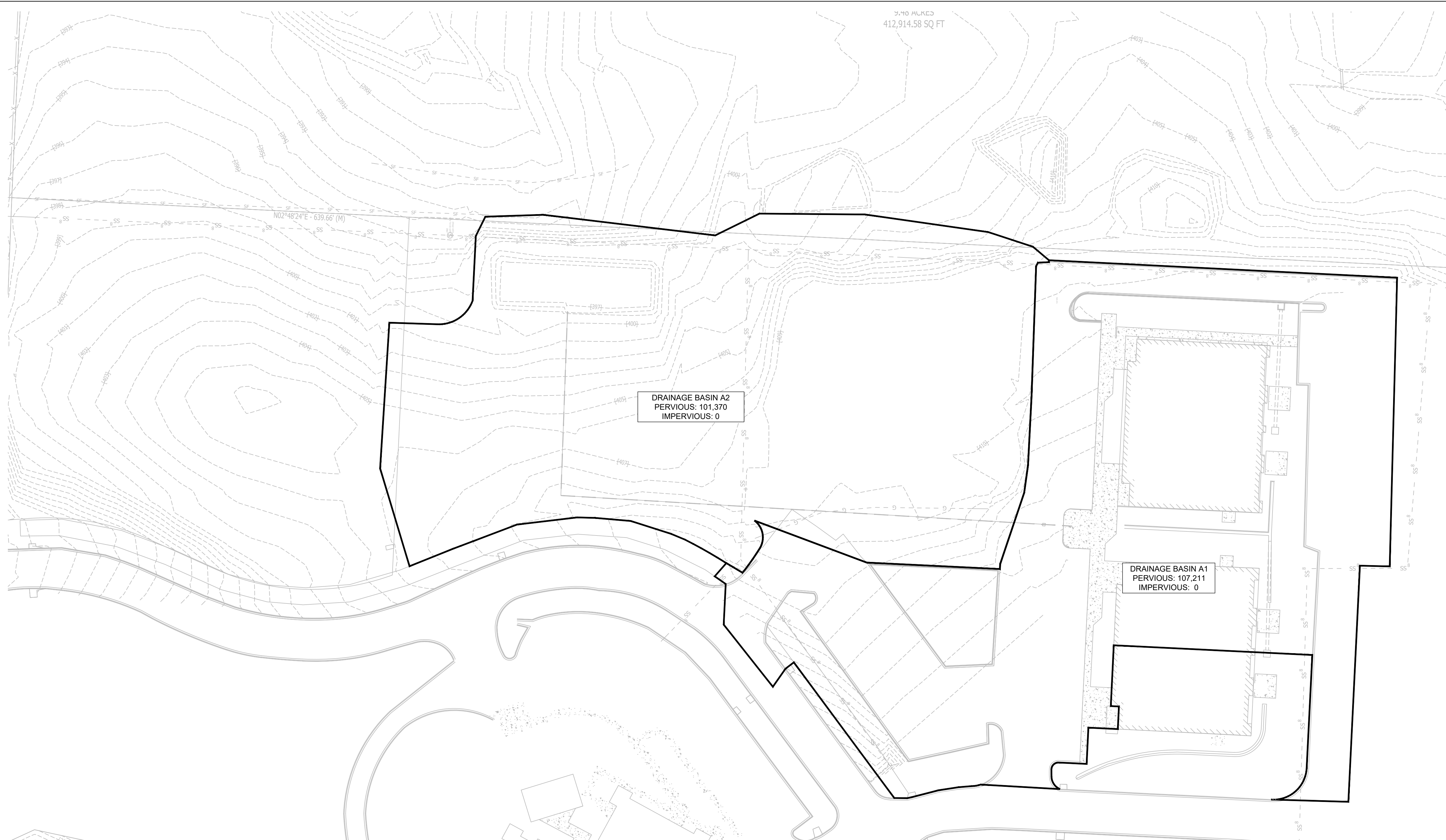

3.40 ALKED
412,914.58 SQ FT

DRAINAGE BASIN A2
PERVIOUS: 101,370
IMPERVIOUS: 0

DRAINAGE BASIN A1
PERVIOUS: 107,211
IMPERVIOUS: 0

PRE DRAINAGE MAP

SCALE 1" = 40'

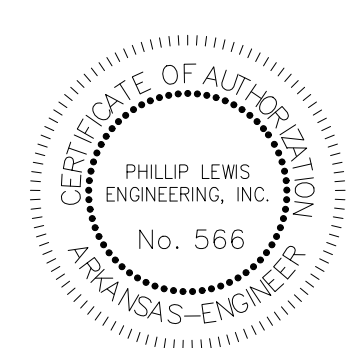
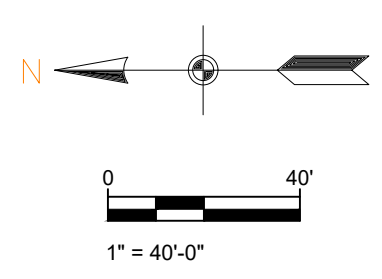

PROJECT NUMBER:

SHEET ISSUE DATE:
1/10/2024

PAGE TITLE:

PRE DRAINAGE
MAP

SHEET NUMBER:

C1.5

PHILLIP LEWIS ENGINEERING, INC.
Structural + Civil Consultants
23620 Interstate 30 | Bryant, Arkansas
PH: 501-350-9840

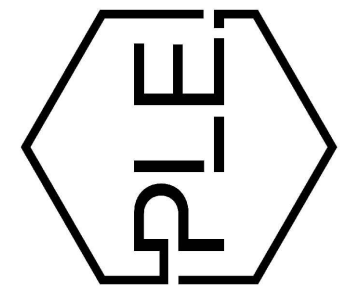

REVISION:

**SUMMERWOOD SPORTS
GYMNASIUM #3**
7817 Hwy 5 N
Bryant, Arkansas

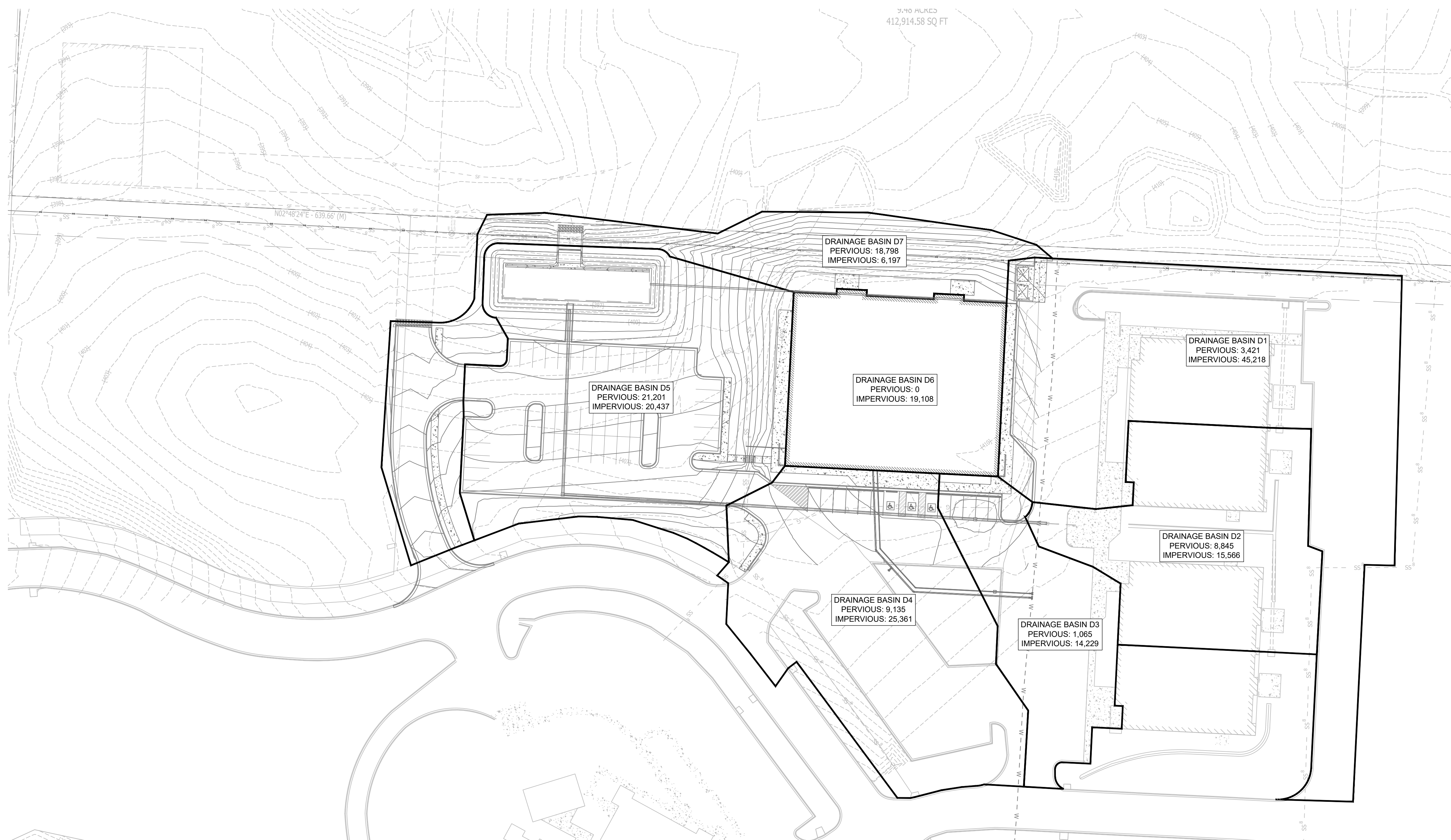

POST DRAINAGE MAP

SCALE 1" = 40'

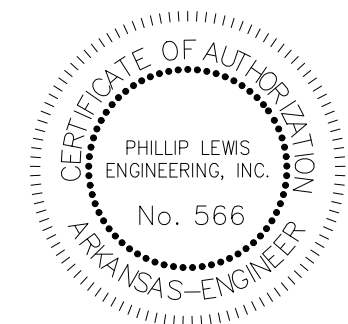
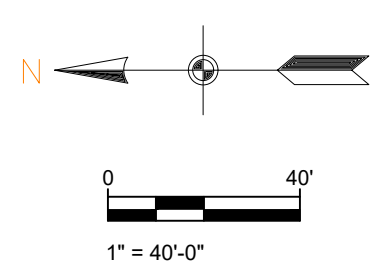

REVISION:

SUMMERWOOD SPORTS GYMNASIUM #3
7817 Hwy 5 N
Bryant, Arkansas

PROJECT NUMBER:
SHEET ISSUE DATE:
PAGE TITLE:

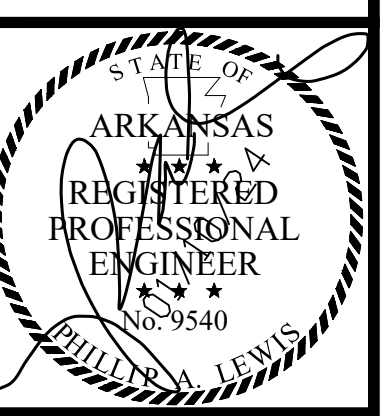

POST DRAINAGE MAP
SHEET NUMBER:
C1.6

DETENTION BASIN OUTLET STRUCTURES

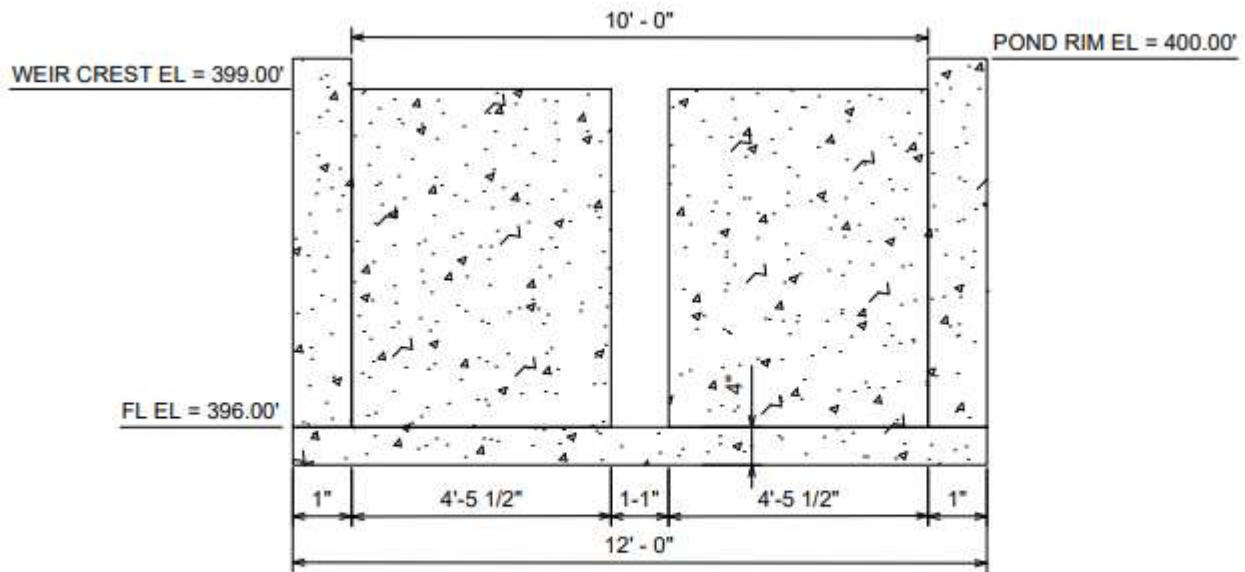

EXISTING DETENTION POND OUTLET STRUCTURE DETAIL

NOT TO SCALE

SOIL CLASSIFICATION MAPS

Custom Soil Resource Report Soil Map



Soil Map may not be valid at this scale.

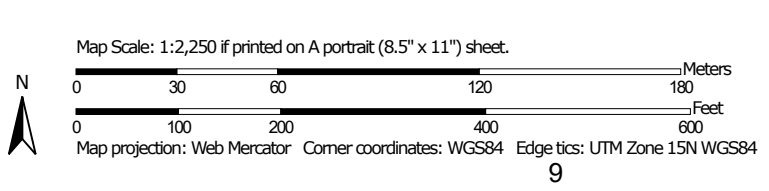

Saline County, Arkansas

29—Tiak silt loam, 3 to 8 percent slopes

Map Unit Setting

National map unit symbol: m06q
Elevation: 70 to 570 feet
Mean annual precipitation: 44 to 61 inches
Mean annual air temperature: 49 to 74 degrees F
Frost-free period: 185 to 230 days
Farmland classification: Not prime farmland

Map Unit Composition

Tiak and similar soils: 100 percent
Estimates are based on observations, descriptions, and transects of the mapunit.

Description of Tiak

Setting

Landform: Interfluves
Down-slope shape: Convex
Across-slope shape: Linear
Parent material: Loamy and clayey marine deposits

Typical profile

A - 0 to 7 inches: silt loam
E - 7 to 9 inches: loam
Bt1 - 9 to 32 inches: clay
Bt2 - 32 to 72 inches: clay

Properties and qualities

Slope: 3 to 8 percent
Depth to restrictive feature: More than 80 inches
Drainage class: Moderately well drained
Runoff class: Very high
Capacity of the most limiting layer to transmit water (Ksat): Moderately low to moderately high (0.06 to 0.20 in/hr)
Depth to water table: About 12 to 24 inches
Frequency of flooding: None
Frequency of ponding: None
Available water supply, 0 to 60 inches: High (about 9.3 inches)

Interpretive groups

Land capability classification (irrigated): None specified
Land capability classification (nonirrigated): 3e
Hydrologic Soil Group: C/D
Ecological site: F133BY002TX - Seasonally Wet Upland
Hydric soil rating: No

FEMA FLOOD INSURANCE RATE MAP

National Flood Hazard Layer FIRMette



92°28'37"W 34°38'34"N

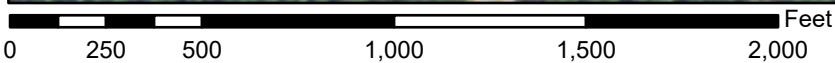
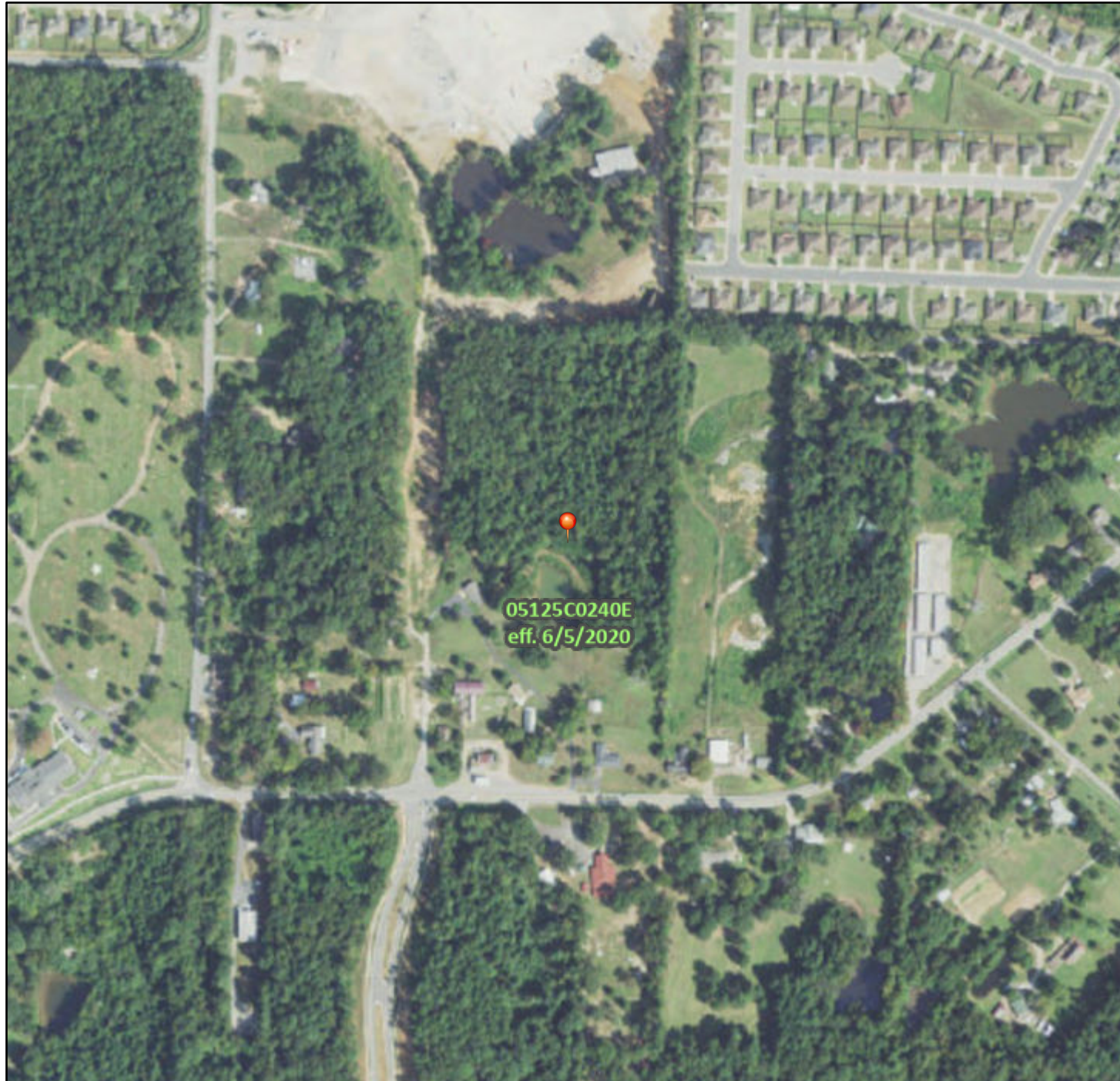

1:6,000

92°28'W 34°38'4"N

Basemap Imagery Source: USGS National Map 2023

Legend

SEE FIS REPORT FOR DETAILED LEGEND AND INDEX MAP FOR FIRM PANEL LAYOUT

- | | | |
|------------------------------------|--|--|
| SPECIAL FLOOD HAZARD AREAS | | Without Base Flood Elevation (BFE)
<i>Zone A, V, A99</i> |
| | | With BFE or Depth <i>Zone AE, AO, AH, VE, AR</i> |
| | | Regulatory Floodway |
| OTHER AREAS OF FLOOD HAZARD | | 0.2% Annual Chance Flood Hazard, Areas of 1% annual chance flood with average depth less than one foot or with drainage areas of less than one square mile <i>Zone X</i> |
| | | Future Conditions 1% Annual Chance Flood Hazard <i>Zone X</i> |
| | | Area with Reduced Flood Risk due to Levee. See Notes. <i>Zone X</i> |
| | | Area with Flood Risk due to Levee <i>Zone D</i> |
| OTHER AREAS | | NO SCREEN Area of Minimal Flood Hazard <i>Zone X</i> |
| | | Effective LOMRs |
| GENERAL STRUCTURES | | Area of Undetermined Flood Hazard <i>Zone D</i> |
| | | Channel, Culvert, or Storm Sewer |
| | | Levee, Dike, or Floodwall |
| OTHER FEATURES | | Cross Sections with 1% Annual Chance Water Surface Elevation |
| | | Coastal Transect |
| | | Base Flood Elevation Line (BFE) |
| | | Limit of Study |
| | | Jurisdiction Boundary |
| MAP PANELS | | Coastal Transect Baseline |
| | | Profile Baseline |
| | | Hydrographic Feature |
| | | Digital Data Available |
| | | No Digital Data Available |
| | | Unmapped |
| | | The pin displayed on the map is an approximate point selected by the user and does not represent an authoritative property location. |



This map complies with FEMA's standards for the use of digital flood maps if it is not void as described below. The basemap shown complies with FEMA's basemap accuracy standards

The flood hazard information is derived directly from the authoritative NFHL web services provided by FEMA. This map was exported on **1/10/2024 at 5:31 PM** and does not reflect changes or amendments subsequent to this date and time. The NFHL and effective information may change or become superseded by new data over time.

This map image is void if the one or more of the following map elements do not appear: basemap imagery, flood zone labels, legend, scale bar, map creation date, community identifiers, FIRM panel number, and FIRM effective date. Map images for unmapped and unmodernized areas cannot be used for regulatory purposes.

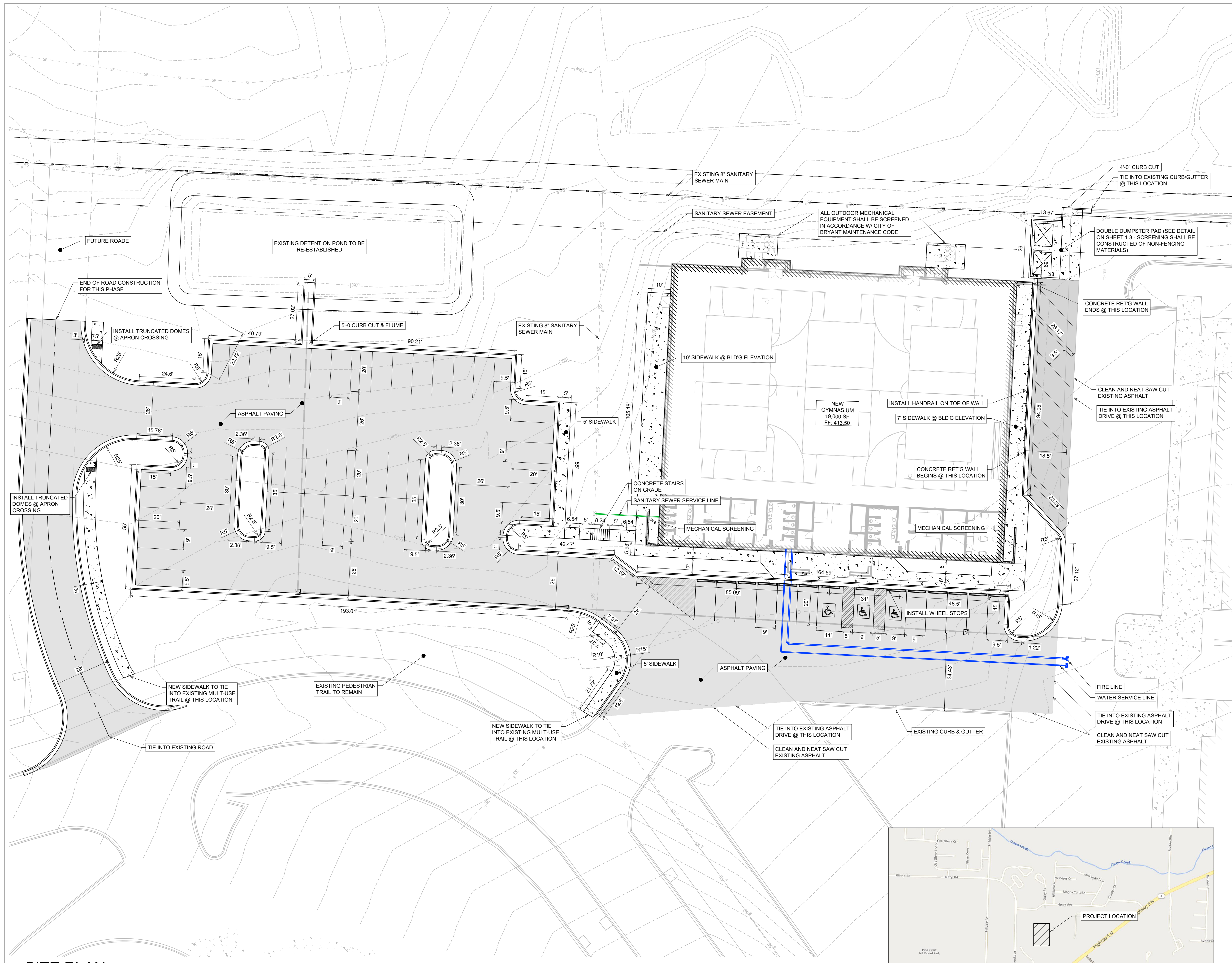

GENERAL CONSTRUCTION NOTES

- A. THE CONTRACTOR WILL BE HELD SOLELY RESPONSIBLE FOR DAMAGES OCCURRING TO ANY PROPERTY DURING THE CONSTRUCTION OF THIS PROJECT. SAID CONTRACTOR SHALL TAKE ALL NECESSARY PRECAUTIONS TO PREVENT PROPERTY DAMAGE.
- B. IN ACCORDANCE WITH GENERALLY ACCEPTED CONSTRUCTION PRACTICES, THE CONTRACTOR WILL SOLELY AND COMPLETELY BE RESPONSIBLE FOR CONDITIONS OF THE JOB SITE, INCLUDING SAFETY WORK. THIS REQUIREMENT WILL APPLY CONTINUOUSLY AND WILL NOT BE LIMITED TO NORMAL WORKING HOURS.
- C. THE DUTY OF BRYANT UTILITIES TO CONDUCT CONSTRUCTION INSPECTION REVIEWS OF THE CONTRACTOR'S PERFORMANCE IS NOT AN INSPECTION OR REVIEW OF THE ADEQUACY OF THE CONTRACTOR'S SAFETY MEASURES IN, ON, OR NEAR THE CONSTRUCTION SITE.
- D. ALL WATER AND SEWER IMPROVEMENTS SHALL BE CONSTRUCTED IN ACCORDANCE WITH THE LATEST REVISION TO THE CITY OF BRYANT'S WATER AND WASTEWATER (SANITARY SEWER) STANDARD SPECIFICATIONS.
- E. THE CONTRACTOR IS SPECIFICALLY CAUTIONED THAT THE LOCATION AND/OR ELEVATION OF EXISTING UTILITIES AS SHOWN ON THESE PLANS IS BASED ON RECORDS OF THE VARIOUS UTILITY COMPANIES AND, WHERE POSSIBLE, MEASUREMENTS TAKEN IN THE FIELD. THE INFORMATION IS NOT TO BE RELIED ON AS BEING EXACT OR COMPLETE. THE CONTRACTOR MUST CALL THE APPROPRIATE UTILITY COMPANY AT LEAST 48 HOURS BEFORE ANY EXCAVATION TO REQUEST EXACT FIELD LOCATION OF ALL UTILITIES. IT SHALL BE THE RESPONSIBILITY OF THE CONTRACTOR TO LOCATE ALL EXISTING UTILITIES WHICH CONFLICT WITH PROPOSED IMPROVEMENTS SHOWN ON THE PLAN.
- F. CONTRACTOR IS TO REMOVE AND DISPOSE OF ALL DEBRIS, RUBBISH, AND OTHER MATERIALS RESULTING FROM PREVIOUS AND CURRENT DEMOLITION OPERATIONS. DISPOSAL WILL BE IN ACCORDANCE WITH ALL LOCAL, STATE AND/OR FEDERAL REGULATIONS GOVERNING SUCH OPERATIONS.
- G. PRIOR TO INSTALLATION OF ANY UTILITIES, THE CONTRACTOR IS TO EXCAVATE, VERIFY AND CALCULATE ALL CROSSINGS AND INFORM ANY AND ALL UTILITIES OF ANY CONFLICTS PRIOR TO CONSTRUCTION.
- H. CONSTRUCTION SHALL NOT START ON ANY WATER UTILITY TIE-INS UNTIL APPROVAL IS GIVEN BY BRYANT UTILITIES. SAID CONTRACTOR SHALL NOT OPERATE ANY VALVE, HYDRANT, OR WATER UTILITY APPURTENANCE NOR SHALL HE ATTACH TO OR TAP ANY WATER UTILITY MAIN WITHOUT APPROVAL. THE CONTRACTOR SHALL BEAR THE COST AND CONSEQUENCE OF ANY DISRUPTION OF UTILITY OPERATION CAUSED BY CONSTRUCTION.
- I. FIBER OPTIC CABLE ON AND/OR ADJACENT TO THIS SITE WERE NOT LOCATED BY THE SURVEY AND ARE NOT SHOWN. IT IS THE RESPONSIBILITY OF THE CONTRACTOR TO LOCATE ANY FIBER OPTIC CABLES ASSOCIATED WITH THIS SITE AND TAKE ALL NECESSARY AND REQUIRED PRECAUTIONS TO PROTECT ANY EXISTING FIBER OPTIC CABLES. CONTRACTORS SHALL COORDINATE ALL EFFORTS WITH OWNER OF FIBER OPTIC CABLES OR THEIR DESIGNATED REPRESENTATIVE.
- J. THE CONTRACTOR IS RESPONSIBLE FOR CONTACTING "ONECALL" SERVICE TO MARK ALL UTILITIES PRIOR TO ANY DEMOLITION, EARTHWORK, OR UTILITY WORK ON THIS SITE.

PHILLIP LEWIS ENGINEERING, INC.
Structural + Civil Consultants
23620 Interstate 30 | Bryant, Arkansas
PH: 501-350-9840

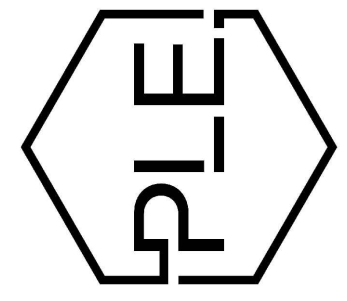

REVISION:

REVISION:

SUMMERWOOD SPORTS GYMNASIUM #3
7817 Hwy 5 N
Bryant, Arkansas

SITE PLAN

1. 64 PARKING SPACES PROVIDED INCLUDING 3 ADA ACCESSIBLE PARKING SPACES
2. ALL DIMENSIONS ARE TO THE BACK OF CURB AND/OR EDGE OF PAVEMENT
3. DAMAGE TO PUBLIC AND PRIVATE PROPERTY DUE TO HAULING OPERATIONS OR OPERATIONS OF CONSTRUCTION RELATED EQUIPMENT FROM A CONSTRUCTION SITE SHALL BE REPAIRED BY THE RESPONSIBLE PARTY PRIOR TO THE ISSUANCE OF A CERTIFICATE OF OCCUPANCY.
4. REPAIR, REPLACE, OR EXTEND EXISTING DAMAGED OR MISSING CURB AND GUTTER, SIDEWALK OR RAMPS WITHIN THE PUBLIC RIGHT OF WAY.
5. ALL SIGNAGE, PAVEMENT MARKING AND PARKING LOT STRIPING SHALL CONFORM TO REQUIREMENTS GIVEN IN MANUAL OF UNIFORM TRAFFIC CONTROL DEVICES (MUTCD). MUTCD REQUIRES THAT PARKING SPACES BE MARKED IN WHITE.

SCALE 1" = 20'

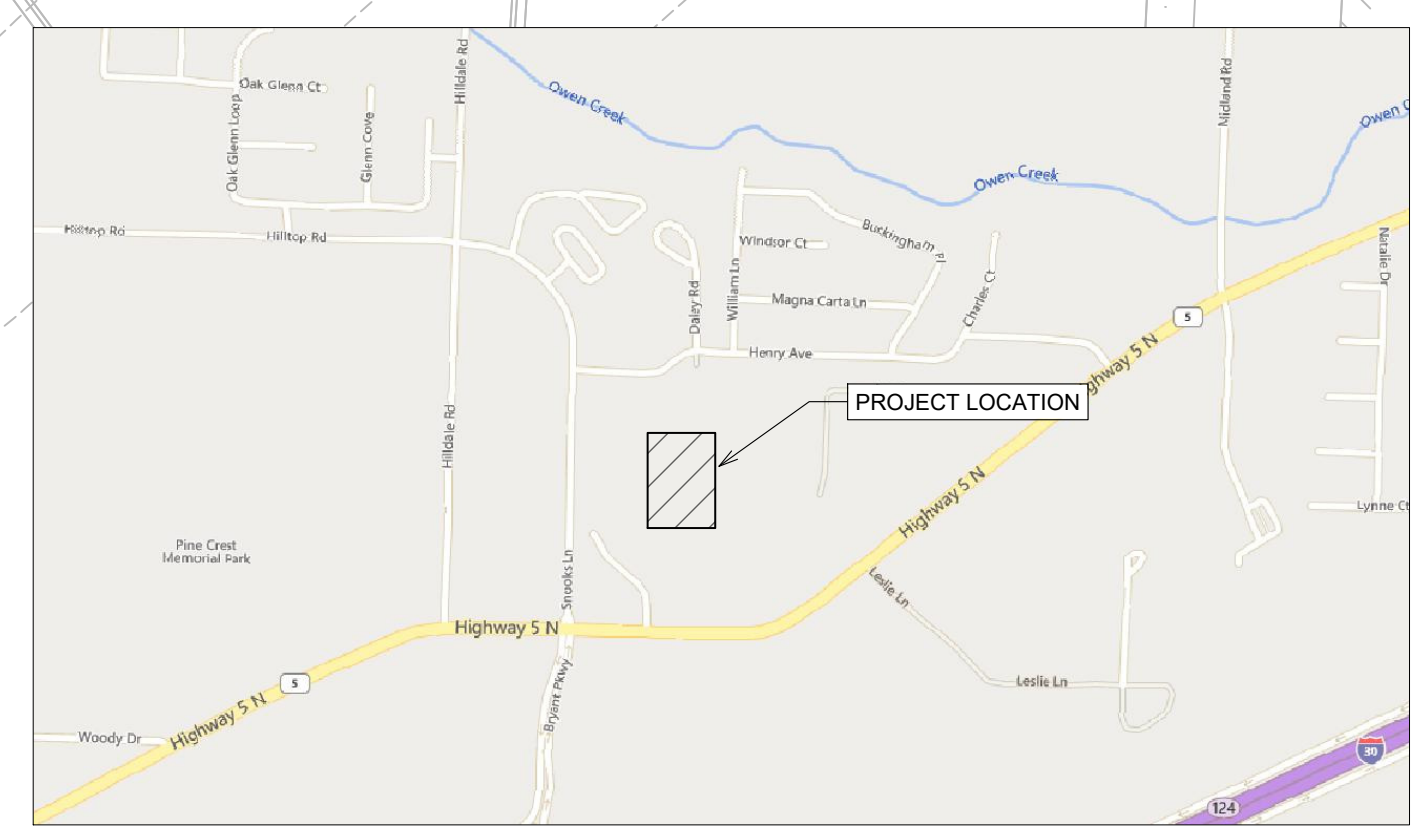

VICINITY MAP
SCALE 1" = 1000'

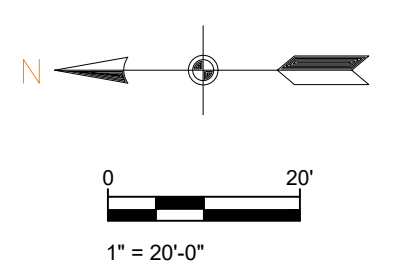

PRELIMINARY NOT FOR CONSTRUCTION

PROJECT NUMBER:

SHEET ISSUE DATE: 12/12/2023

PAGE TITLE:

SITE PLAN

SHEET NUMBER:

C1.1

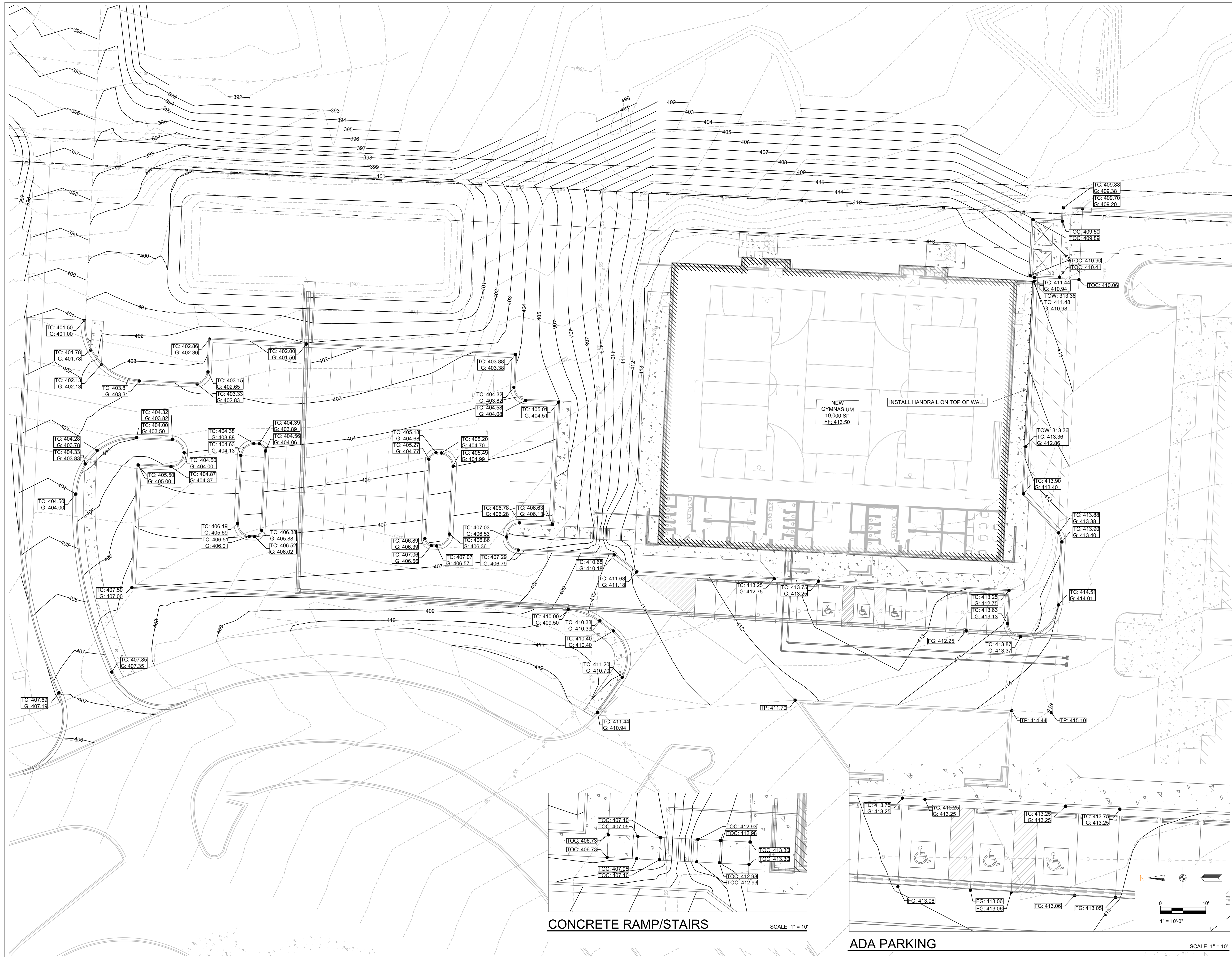

GRADING PLAN

G = GUTTER ELEVATION
 TP = TOP OF PAVEMENT ELEVATION
 TOC = TOP OF CONCRETE ELEVATION
 FG = FINAL GRADE ELEVATION (NON PAVED AREAS)
 TC = TOP OF CURB ELEVATION
 TOW = TOP OF WALL

SCALE 1" = 20'

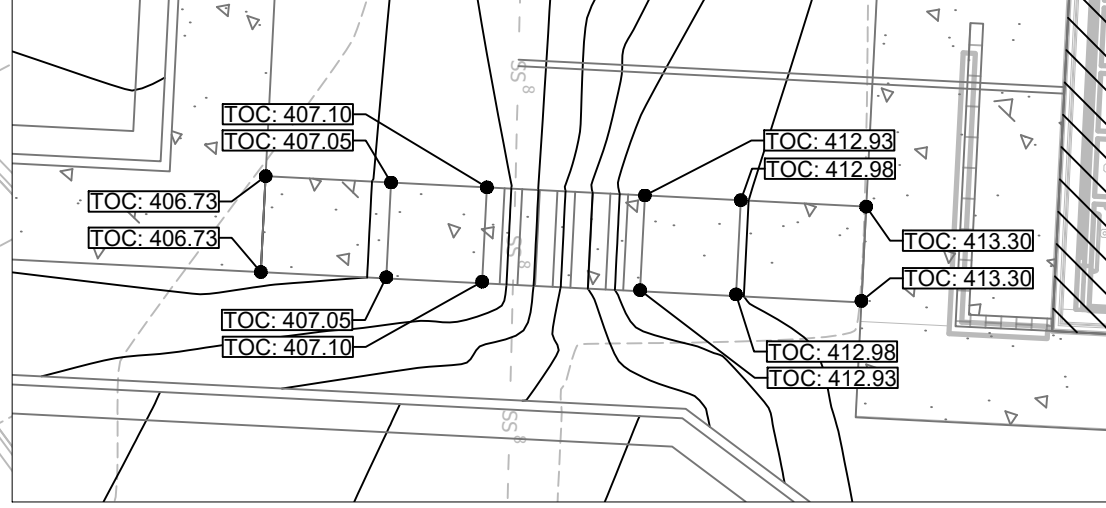

CONCRETE RAMP/STAIRS

SCALE 1" = 10'

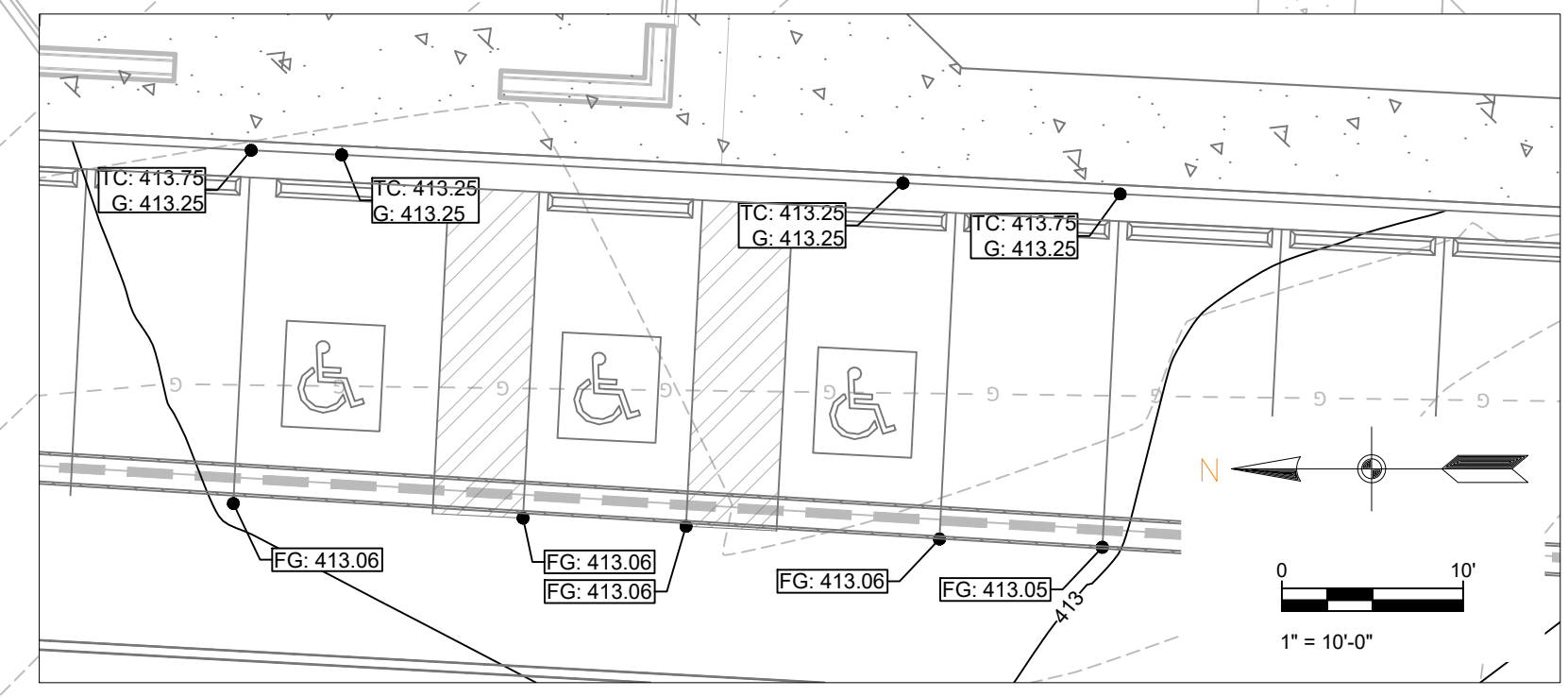

ADA PARKING

SCALE 1" = 10'

GENERAL CONSTRUCTION NOTES

- A. THE CONTRACTOR WILL BE HELD SOLELY RESPONSIBLE FOR DAMAGES OCCURRING TO ANY PROPERTY DURING THE CONSTRUCTION OF THIS PROJECT. SAID CONTRACTOR SHALL TAKE ALL NECESSARY PRECAUTIONS TO PREVENT PROPERTY DAMAGE.
- B. IN ACCORDANCE WITH GENERALLY ACCEPTED CONSTRUCTION PRACTICES, THE CONTRACTOR WILL SOLELY AND COMPLETELY BE RESPONSIBLE FOR CONDITIONS OF THE JOB SITE, INCLUDING SAFETY WORK. THIS REQUIREMENT WILL APPLY CONTINUOUSLY AND WILL NOT BE LIMITED TO NORMAL WORKING HOURS.
- C. THE DUTY OF BRYANT UTILITIES TO CONDUCT CONSTRUCTION INSPECTION REVIEWS OF THE CONTRACTOR'S PERFORMANCE IS NOT AN INSPECTION OR REVIEW OF THE ADEQUACY OF THE CONTRACTOR'S SAFETY MEASURES IN, ON, OR NEAR THE CONSTRUCTION SITE.
- D. ALL WATER AND SEWER IMPROVEMENTS SHALL BE CONSTRUCTED IN ACCORDANCE WITH THE LATEST REVISION TO THE CITY OF BRYANT'S WATER AND WASTEWATER (SANITARY SEWER) STANDARD SPECIFICATIONS.
- E. THE CONTRACTOR IS SPECIFICALLY CAUTIONED THAT THE LOCATION AND/OR ELEVATION OF EXISTING UTILITIES AS SHOWN ON THESE PLANS IS BASED ON RECORDS OF THE VARIOUS UTILITY COMPANIES AND, WHERE POSSIBLE, MEASUREMENTS TAKEN IN THE FIELD. THE INFORMATION IS NOT TO BE RELIED ON AS BEING EXACT OR COMPLETE. THE CONTRACTOR MUST CALL THE APPROPRIATE UTILITY COMPANY AT LEAST 48 HOURS BEFORE ANY EXCAVATION TO REQUEST EXACT FIELD LOCATION OF ALL UTILITIES. IT SHALL BE THE RESPONSIBILITY OF THE CONTRACTOR TO LOCATE ALL EXISTING UTILITIES WHICH CONFLICT WITH PROPOSED IMPROVEMENTS SHOWN ON THE PLAN.
- F. CONTRACTOR IS TO REMOVE AND DISPOSE OF ALL DEBRIS, RUBBISH, AND OTHER MATERIALS RESULTING FROM PREVIOUS AND CURRENT DEMOLITION OPERATIONS. DISPOSAL WILL BE IN ACCORDANCE WITH ALL LOCAL, STATE AND/OR FEDERAL REGULATIONS GOVERNING SUCH OPERATIONS.
- G. PRIOR TO INSTALLATION OF ANY UTILITIES, THE CONTRACTOR IS TO EXCAVATE, VERIFY AND CALCULATE ALL CROSSINGS AND INFORM ANY AND ALL UTILITIES OF ANY CONFLICTS PRIOR TO CONSTRUCTION.
- H. CONSTRUCTION SHALL NOT START ON ANY WATER UTILITY TIE-INS UNTIL APPROVAL IS GIVEN BY BRYANT UTILITIES. SAID CONTRACTOR SHALL NOT OPERATE ANY VALVE, HYDRANT, OR WATER UTILITY APPURTENANCE NOR SHALL HE ATTACH TO OR TAP ANY WATER UTILITY MAIN WITHOUT APPROVAL. THE CONTRACTOR SHALL BEAR THE COST AND CONSEQUENCE OF ANY DISRUPTION OF UTILITY OPERATION CAUSED BY CONSTRUCTION.
- I. FIBER OPTIC CABLE ON AND/OR ADJACENT TO THIS SITE WERE NOT LOCATED BY THE SURVEY AND ARE NOT SHOWN. IT IS THE RESPONSIBILITY OF THE CONTRACTOR TO LOCATE ANY FIBER OPTIC CABLES ASSOCIATED WITH THIS SITE AND TAKE ALL NECESSARY AND REQUIRED PRECAUTIONS TO PROTECT ANY EXISTING FIBER OPTIC CABLES. CONTRACTORS SHALL COORDINATE ALL EFFORTS WITH OWNER OF FIBER OPTIC CABLES OR THEIR DESIGNATED REPRESENTATIVE.
- J. THE CONTRACTOR IS RESPONSIBLE FOR CONTACTING "ONECALL" SERVICE TO MARK ALL UTILITIES PRIOR TO ANY DEMOLITION, EARTHWORK, OR UTILITY WORK ON THIS SITE.

PHILLIP LEWIS ENGINEERING, INC.
 Structural + Civil Consultants
 23620 Interstate 30 | Bryant, Arkansas
 PH: 501-350-9840



REVISION:

SUMMERWOOD SPORTS GYMNASIUM #3
 7817 Hwy 5 N
 Bryant, Arkansas

PRELIMINARY
 NOT FOR CONSTRUCTION

PROJECT NUMBER:

SHEET ISSUE DATE:
12/12/2023

PAGE TITLE:
GRADING PLAN

SHEET NUMBER:
C1.2

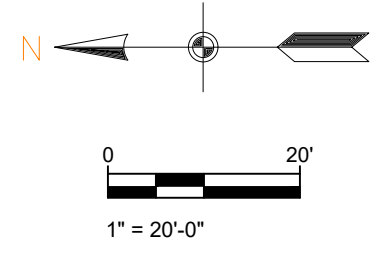

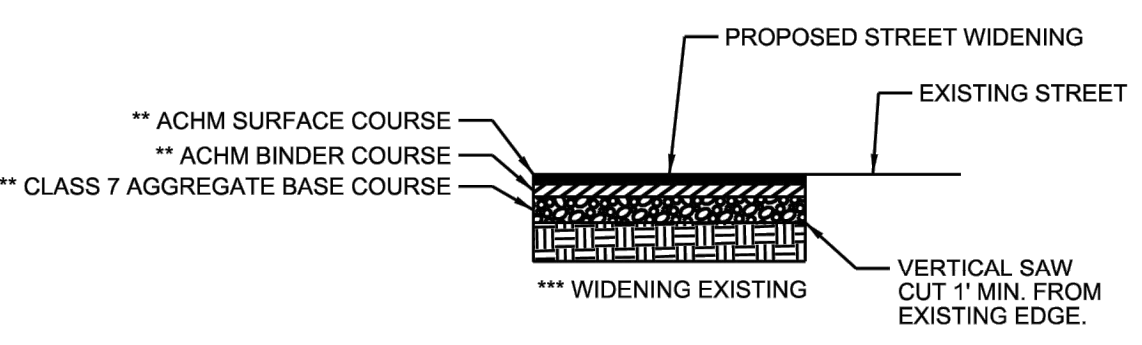
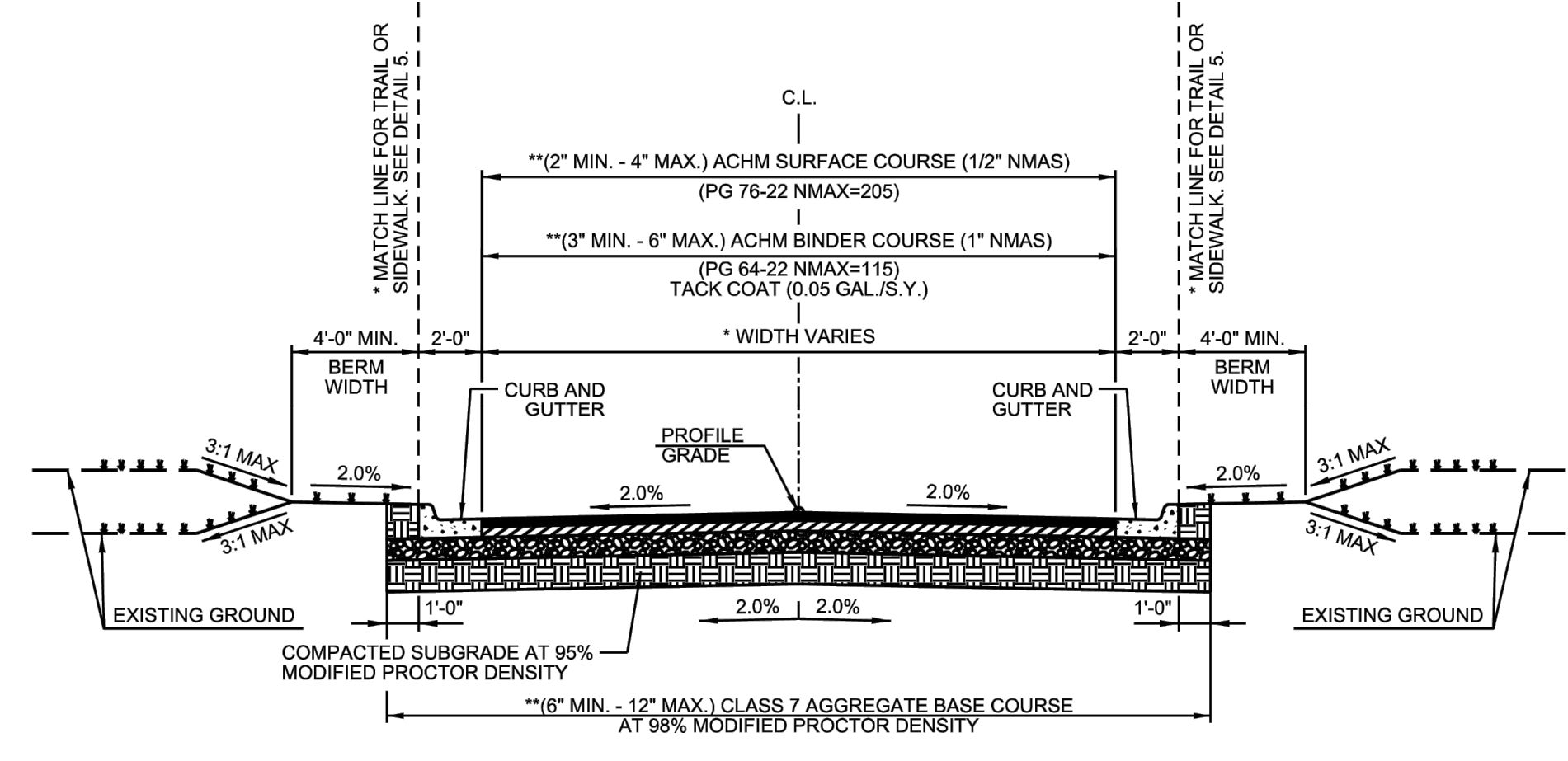

- GENERAL NOTES**
- IN AREAS TO RECEIVE BITUMINOUS PAVING, CONCRETE DRIVEWAYS OR CURB AND GUTTER, SUBGRADE SHALL BE COMPACTED TO A DENSITY NOT LESS THAN 95% OF MAXIMUM MODIFIED DENSITY OBTAINED AT OPTIMUM MOISTURE CONTENT.
 - FOR AREAS OF SUBGRADE PREPARATION TO RECEIVE CONCRETE SIDEWALKS, SUBGRADE SHALL BE COMPACTED TO DENSITY OF 90% MAXIMUM MODIFIED DENSITY.
 - CRUSHED STONE - MATERIAL IN EACH COURSE SHALL BE COMPACTED TO A DENSITY OF 98% MAXIMUM MODIFIED DENSITY.
 - ACHM BASE COURSE (4" MIN. - 12" MAX.) (1 1/2" NMAS) MAY BE USED IF INCLUDED IN AN APPROVED PAVEMENT DESIGN.
- CROSS SECTIONS AND RIGHT-OF-WAY SHALL ADHERE TO THE MINIMUM WIDTH REQUIREMENTS SHOWN IN THE CITY OF BRYANT MASTER TRANSPORTATION PLAN. THE DEVELOPMENT REVIEW COMMITTEE SHALL DETERMINE WHICH VERSION OF STREET CLASSIFICATION AND WHAT WIDTHS WILL BE REQUIRED.**
- THICKNESS TO BE DETERMINED BY PAVEMENT DESIGN IN ACCORDANCE WITH SECTION 5.0 OF THE MINIMUM STANDARD SPECIFICATIONS FOR STREETS.**
- PAVEMENT RECONSTRUCTION TO CENTERLINE IS REQUIRED WHEN EXISTING STREET DOES NOT MEET THESE STANDARDS.**

CITY OF BRYANT

TYPICAL SECTION MINOR ARTERIAL

ISSUE DATE: AUGUST 2021

REVISION DATE:

DETAIL 1

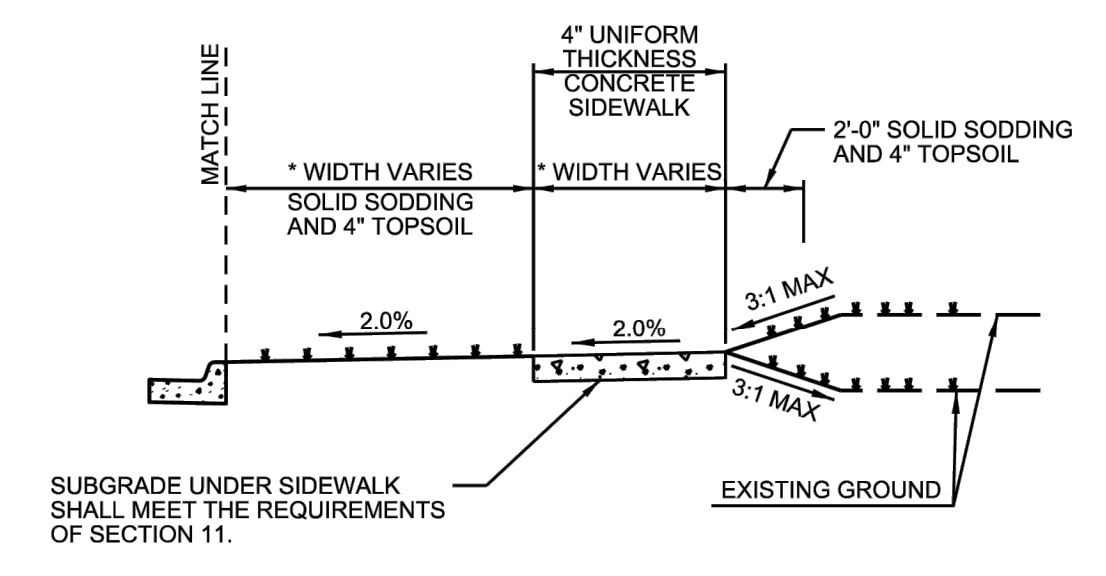
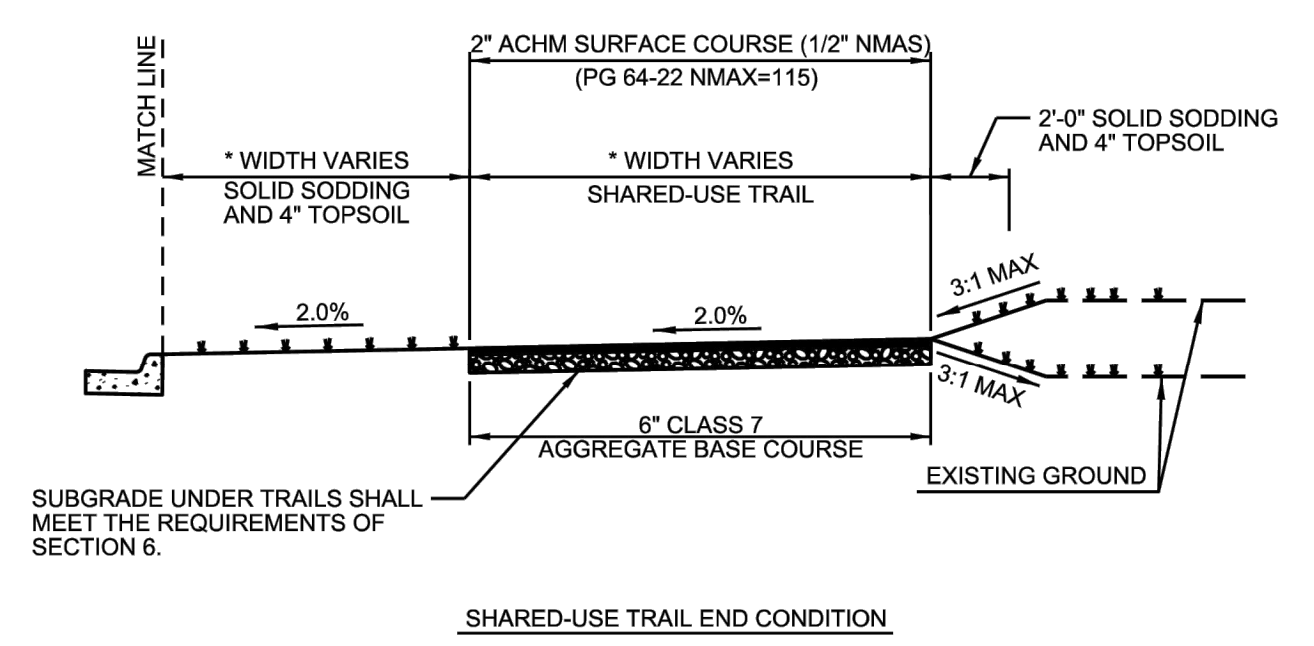

SHARED-USE TRAIL END CONDITION

SIDEWALK END CONDITION

* WIDTH SHALL ADHERE TO THE MINIMUM WIDTH REQUIREMENTS SHOWN IN THE CITY OF BRYANT MASTER TRANSPORTATION PLAN. THE DEVELOPMENT REVIEW COMMITTEE SHALL DETERMINE WHICH VERSION OF STREET CLASSIFICATION AND WHAT WIDTHS WILL BE REQUIRED.

CITY OF BRYANT

TYPICAL SECTION END CONDITIONS

ISSUE DATE: AUGUST 2021

REVISION DATE:

DETAIL 5

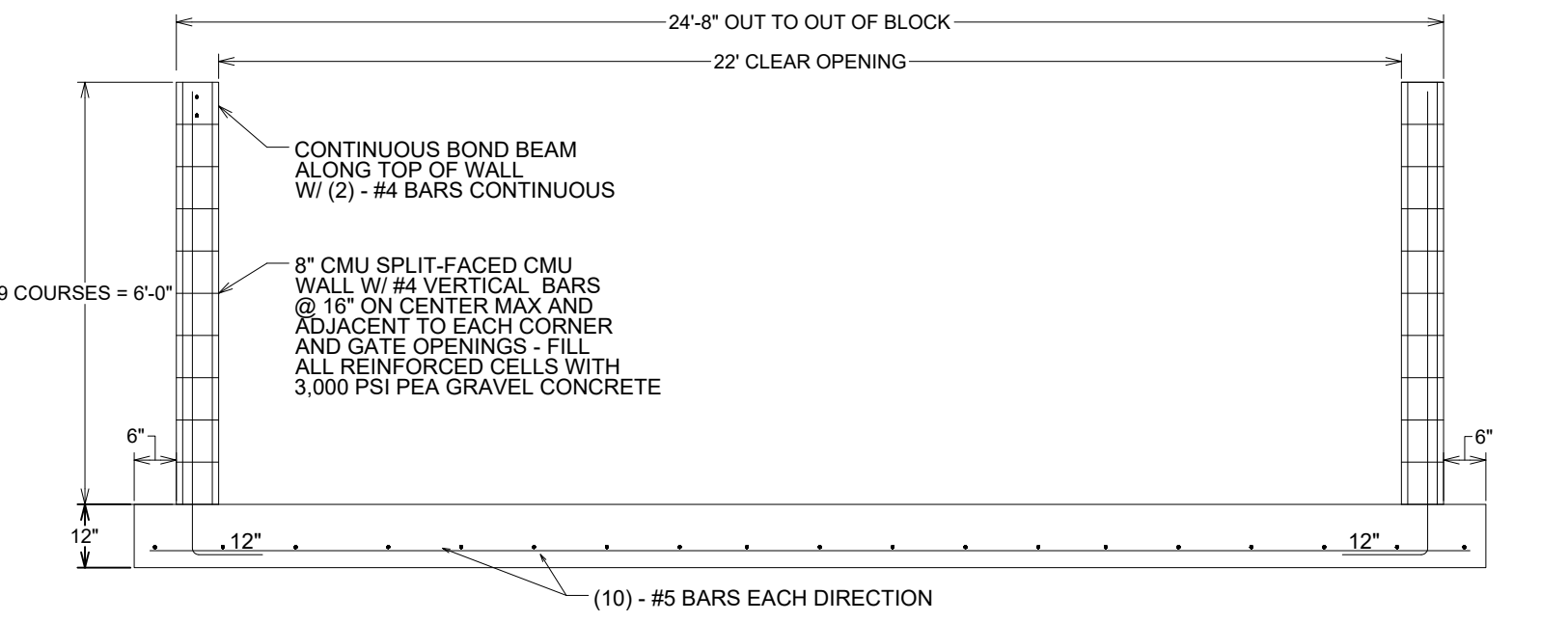
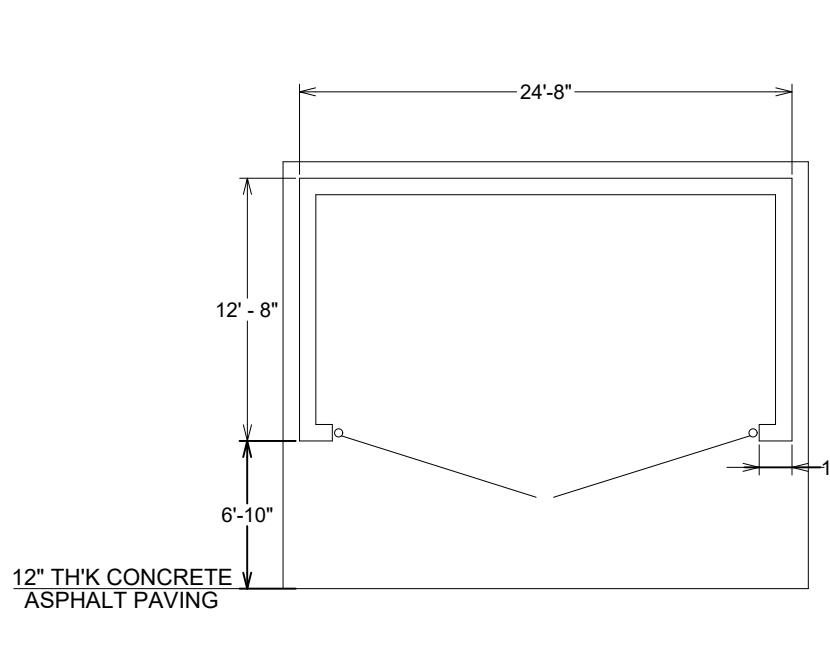
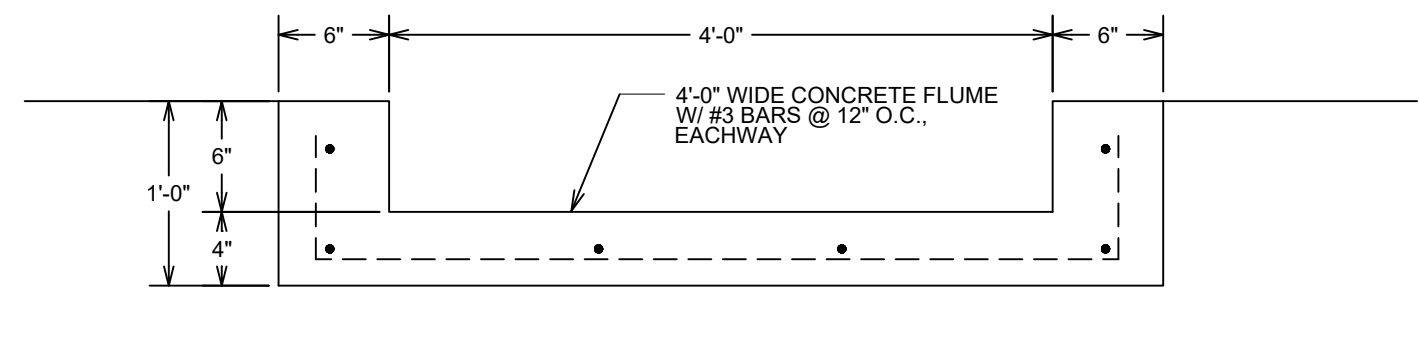
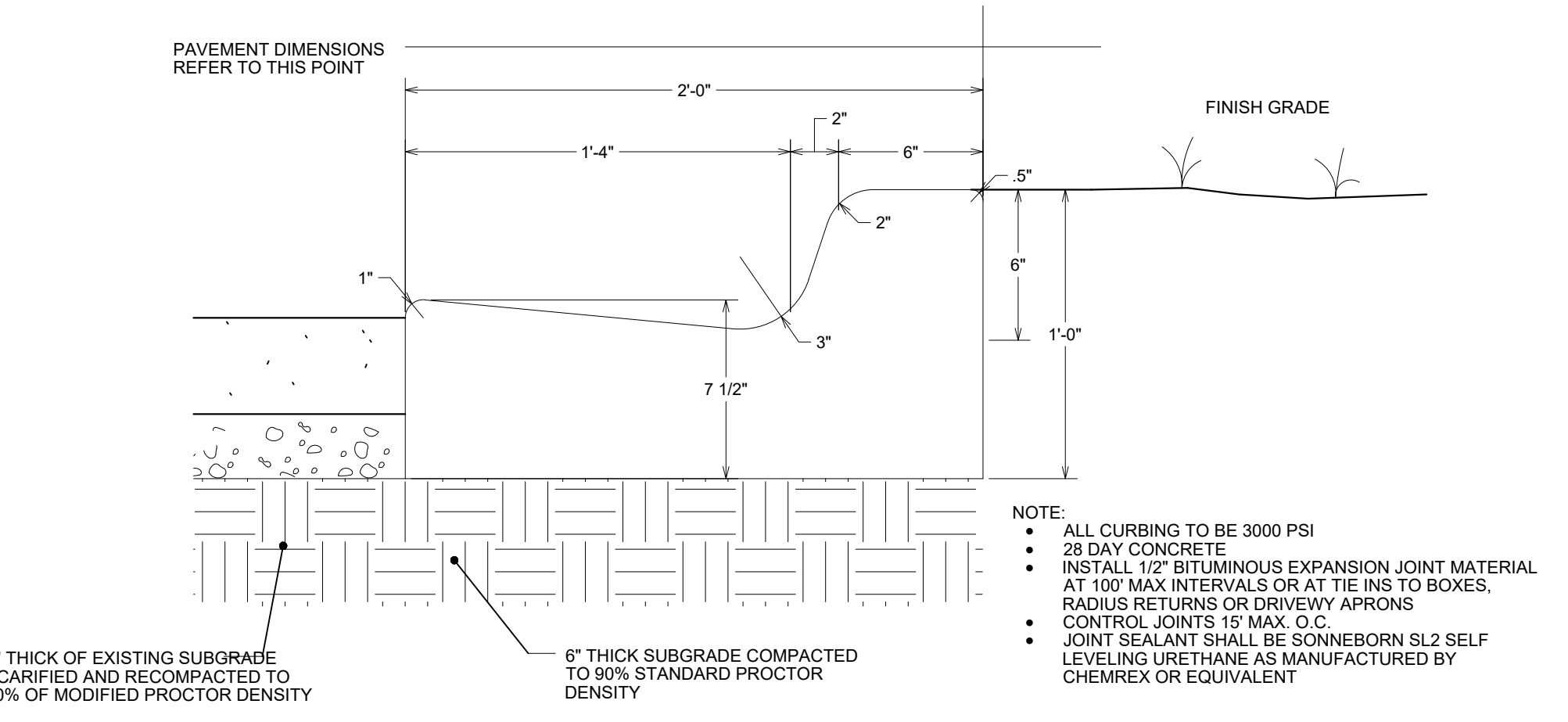
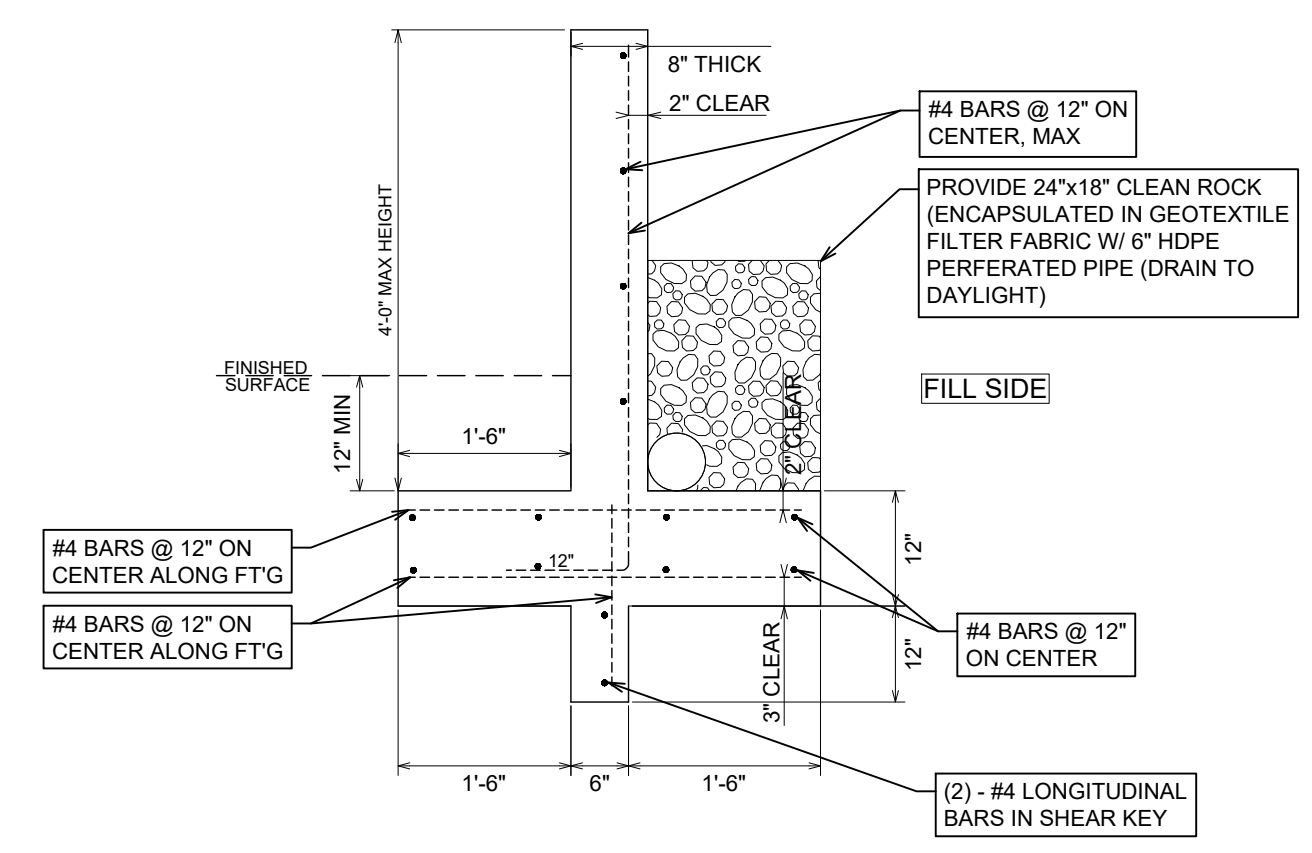
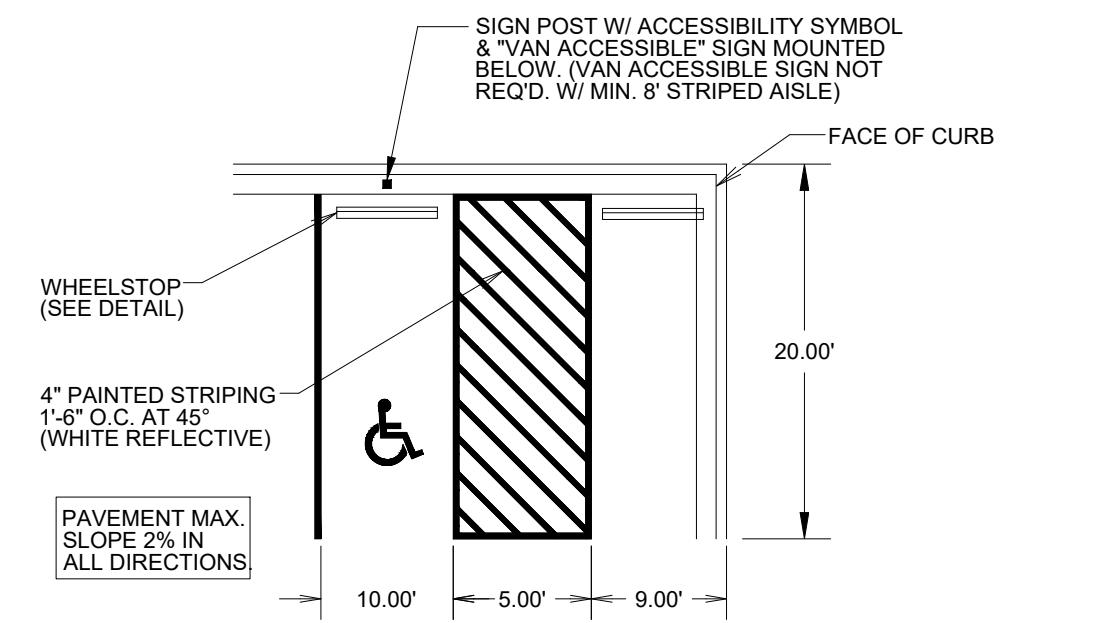
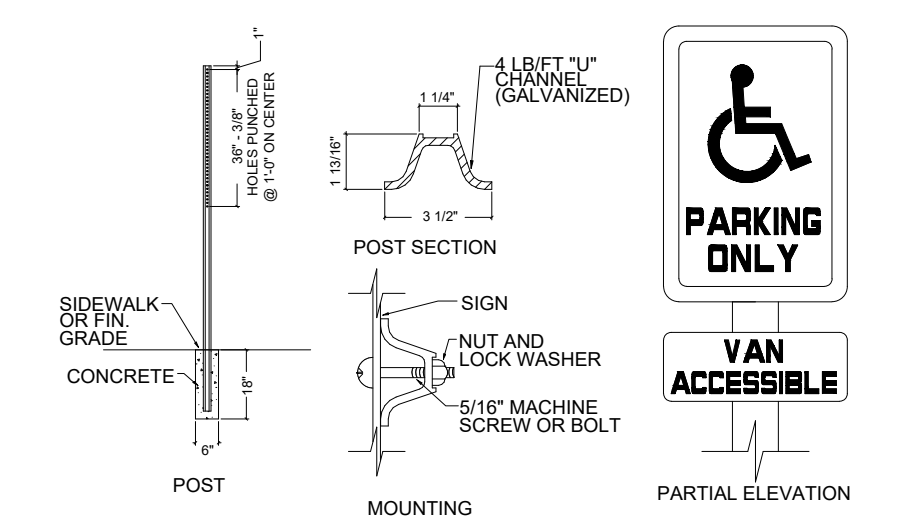
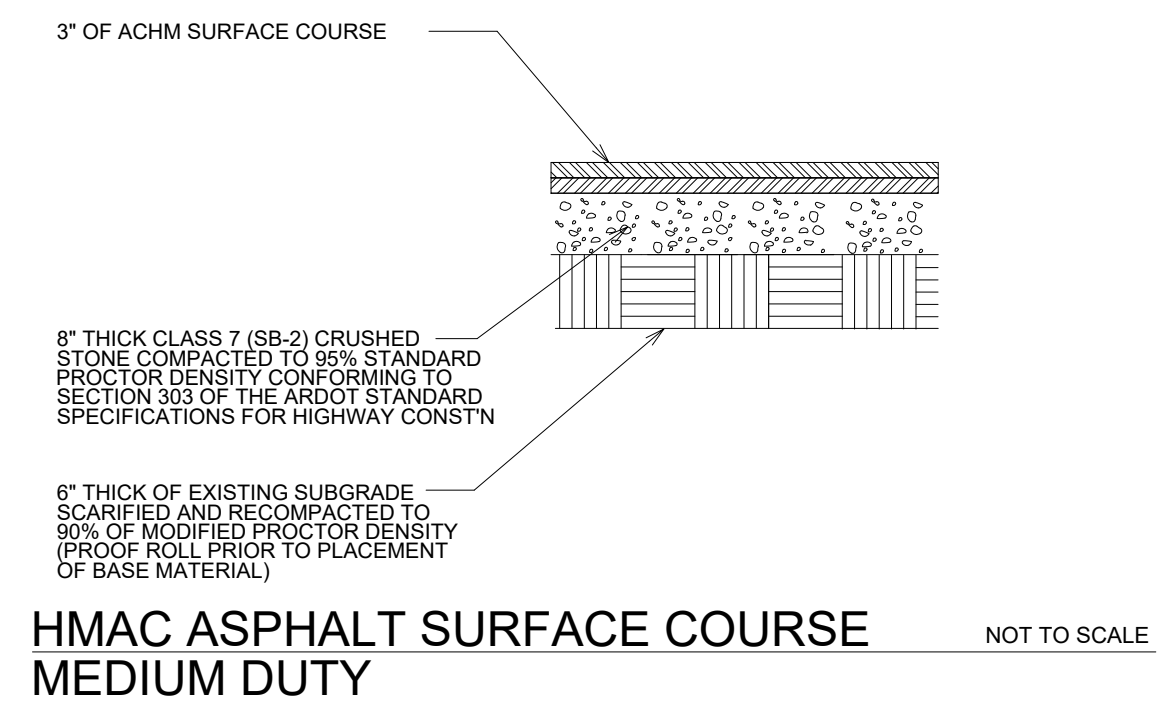

HMAC ASPHALT SURFACE COURSE MEDIUM DUTY

NOTE: HANDICAP SIGNAGE SHALL BE IN STRICT COMPLIANCE WITH CURRENT FEDERAL AND LOCAL LAW REQUIREMENTS.

2'-0" CONCRETE CURB & GUTTER

NOT TO SCALE

HANDICAP SIGN DETAIL

NOTE: HANDICAP SIGNAGE SHALL BE IN STRICT COMPLIANCE WITH CURRENT FEDERAL AND LOCAL LAW REQUIREMENTS.

CONCRETE FLUME DETAIL

NOT TO SCALE

TYPICAL ACCESSIBLE PARKING STALLS

DUMPSTER PAD/ENCLOSURE DETAIL

NOT TO SCALE

RETAINING WALL

NOT TO SCALE

PHILLIP LEWIS ENGINEERING, INC.
Structural + Civil Consultants
23620 Interstate 30 | Bryant, Arkansas
PH: 501-350-9840

PLE

REVISION:

SUMMERWOOD SPORTS GYMNASIUM #3
7817 Hwy 5 N
Bryant, Arkansas

PRELIMINARY
NOT FOR CONSTRUCTION

PROJECT NUMBER:
SHEET ISSUE DATE: 12/12/2023
PAGE TITLE: SITE DETAILS
SHEET NUMBER: C1.3

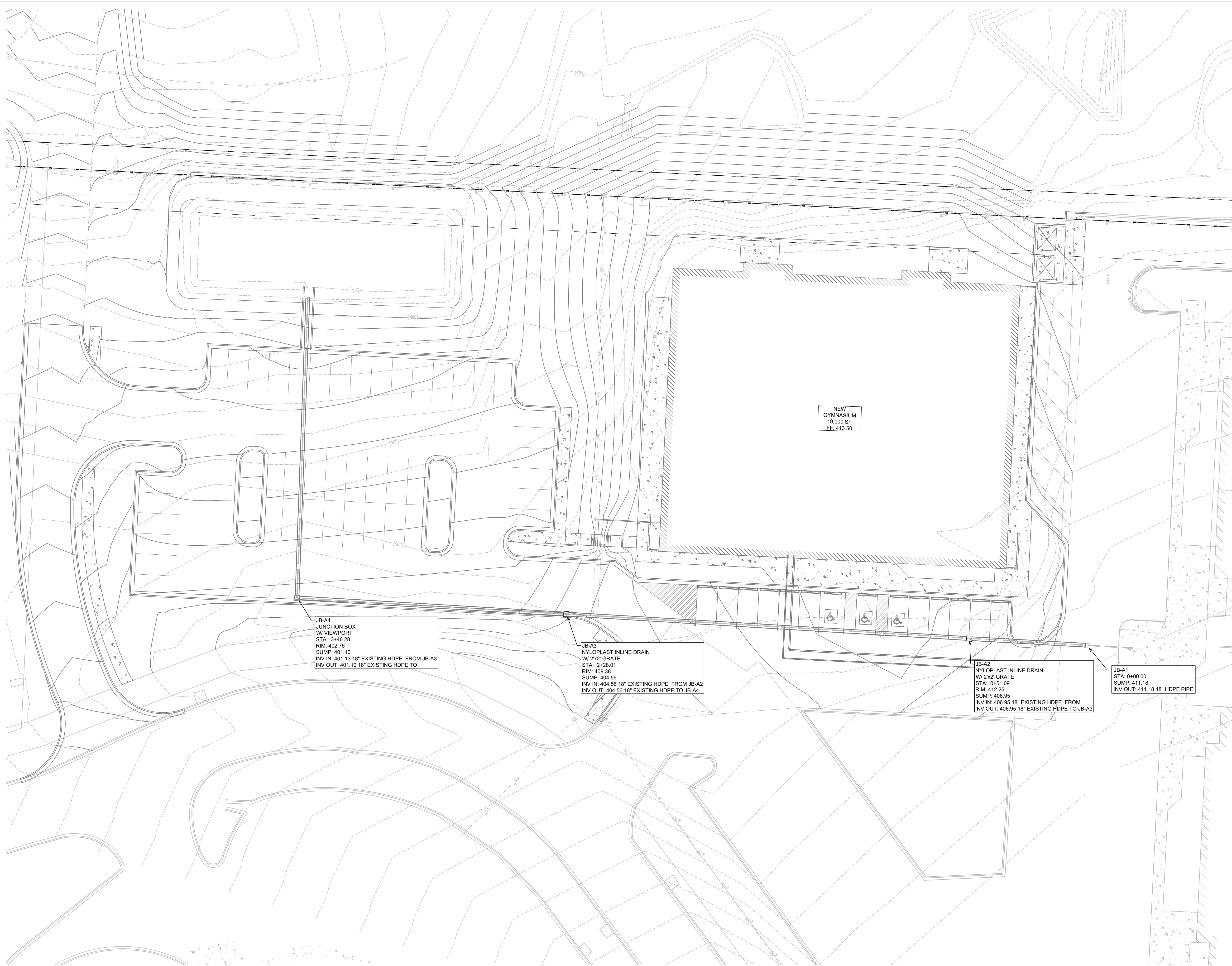

STORMWATER PLAN

SCALE 1" = 30'

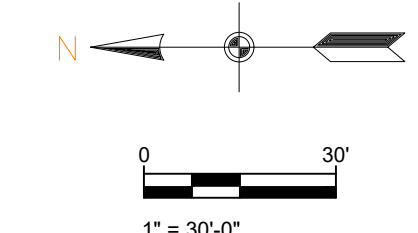

GENERAL CONSTRUCTION NOTES

- A. THE CONTRACTOR WILL BE HELD SOLELY RESPONSIBLE FOR DAMAGES OCCURRING TO ANY PROPERTY DURING THE CONSTRUCTION OF THIS PROJECT. SAID CONTRACTOR SHALL TAKE ALL NECESSARY PRECAUTIONS TO PREVENT PROPERTY DAMAGE.
- B. IN ACCORDANCE WITH GENERALLY ACCEPTED CONSTRUCTION PRACTICES, THE CONTRACTOR WILL SOLELY AND COMPLETELY BE RESPONSIBLE FOR CONDITIONS OF THE JOB SITE, INCLUDING SAFETY WORK. THIS REQUIREMENT WILL APPLY CONTINUOUSLY AND WILL NOT BE LIMITED TO NORMAL WORKING HOURS.
- C. THE DUTY OF BRYANT UTILITIES TO CONDUCT CONSTRUCTION INSPECTION REVIEWS OF THE CONTRACTOR'S PERFORMANCE IS NOT AN INSPECTION OR REVIEW OF THE ADEQUACY OF THE CONTRACTOR'S SAFETY MEASURES IN, ON, OR NEAR THE CONSTRUCTION SITE.
- D. ALL WATER AND SEWER IMPROVEMENTS SHALL BE CONSTRUCTED IN ACCORDANCE WITH THE LATEST REVISION TO THE CITY OF BRYANT'S WATER AND WASTEWATER (SANITARY SEWER) STANDARD SPECIFICATIONS.
- E. THE CONTRACTOR IS SPECIFICALLY CAUTIONED THAT THE LOCATION AND/OR ELEVATION OF EXISTING UTILITIES AS SHOWN ON THESE PLANS IS BASED ON RECORDS OF THE VARIOUS UTILITY COMPANIES AND, WHERE POSSIBLE, MEASUREMENTS TAKEN IN THE FIELD. THE INFORMATION IS NOT TO BE RELIED ON AS BEING EXACT OR COMPLETE. THE CONTRACTOR MUST CALL THE APPROPRIATE UTILITY COMPANY AT LEAST 48 HOURS BEFORE ANY EXCAVATION TO REQUEST EXACT FIELD LOCATION OF ALL UTILITIES. IT SHALL BE THE RESPONSIBILITY OF THE CONTRACTOR TO LOCATE ALL EXISTING UTILITIES WHICH CONFLICT WITH PROPOSED IMPROVEMENTS SHOWN ON THE PLAN.
- F. CONTRACTOR IS TO REMOVE AND DISPOSE OF ALL DEBRIS, RUBBISH, AND OTHER MATERIALS RESULTING FROM PREVIOUS AND CURRENT DEMOLITION OPERATIONS. DISPOSAL WILL BE IN ACCORDANCE WITH ALL LOCAL, STATE AND/OR FEDERAL REGULATIONS GOVERNING SUCH OPERATIONS.
- G. PRIOR TO INSTALLATION OF ANY UTILITIES, THE CONTRACTOR IS TO EXCAVATE, VERIFY AND CALCULATE ALL CROSSINGS AND INFORM ANY AND ALL UTILITIES OF ANY CONFLICTS PRIOR TO CONSTRUCTION.
- H. CONSTRUCTION SHALL NOT START ON ANY WATER UTILITY TIE-INS UNTIL APPROVAL IS GIVEN BY BRYANT UTILITIES. SAID CONTRACTOR SHALL NOT OPERATE ANY VALVE, HYDRANT, OR WATER UTILITY APPURTENANCE NOR SHALL HE ATTACH TO OR TAP ANY WATER UTILITY MAIN WITHOUT APPROVAL. THE CONTRACTOR SHALL BEAR THE COST AND CONSEQUENCE OF ANY DISRUPTION OF UTILITY OPERATION CAUSED BY CONSTRUCTION.
- I. FIBER OPTIC CABLE ON AND/OR ADJACENT TO THIS SITE WERE NOT LOCATED BY THE SURVEY AND ARE NOT SHOWN. IT IS THE RESPONSIBILITY OF THE CONTRACTOR TO LOCATE ANY FIBER OPTIC CABLES ASSOCIATED WITH THIS SITE AND TAKE ALL NECESSARY AND REQUIRED PRECAUTIONS TO PROTECT ANY EXISTING FIBER OPTIC CABLES. CONTRACTORS SHALL COORDINATE ALL EFFORTS WITH OWNER OF FIBER OPTIC CABLES OR THEIR DESIGNATED REPRESENTATIVE.
- J. THE CONTRACTOR IS RESPONSIBLE FOR CONTACTING "ONECALL" SERVICE TO MARK ALL UTILITIES PRIOR TO ANY DEMOLITION, EARTHWORK, OR UTILITY WORK ON THIS SITE.

PHILLIP LEWIS ENGINEERING, INC.
 Structural + Civil Consultants
 23620 Interstate 30 | Bryant, Arkansas
 PH: 501-350-9840

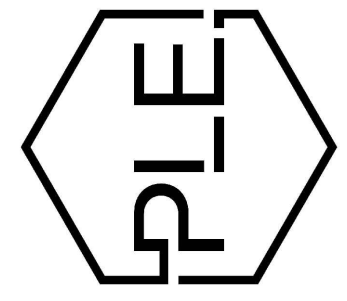

REVISION:

SUMMERWOOD SPORTS GYMNASIUM #3
 7817 Hwy 5 N
 Bryant, Arkansas

PRELIMINARY
 NOT FOR CONSTRUCTION

PROJECT NUMBER:

SHEET ISSUE DATE:
12/12/2023

PAGE TITLE:

STORMWATER PLAN

SHEET NUMBER:

C1.4

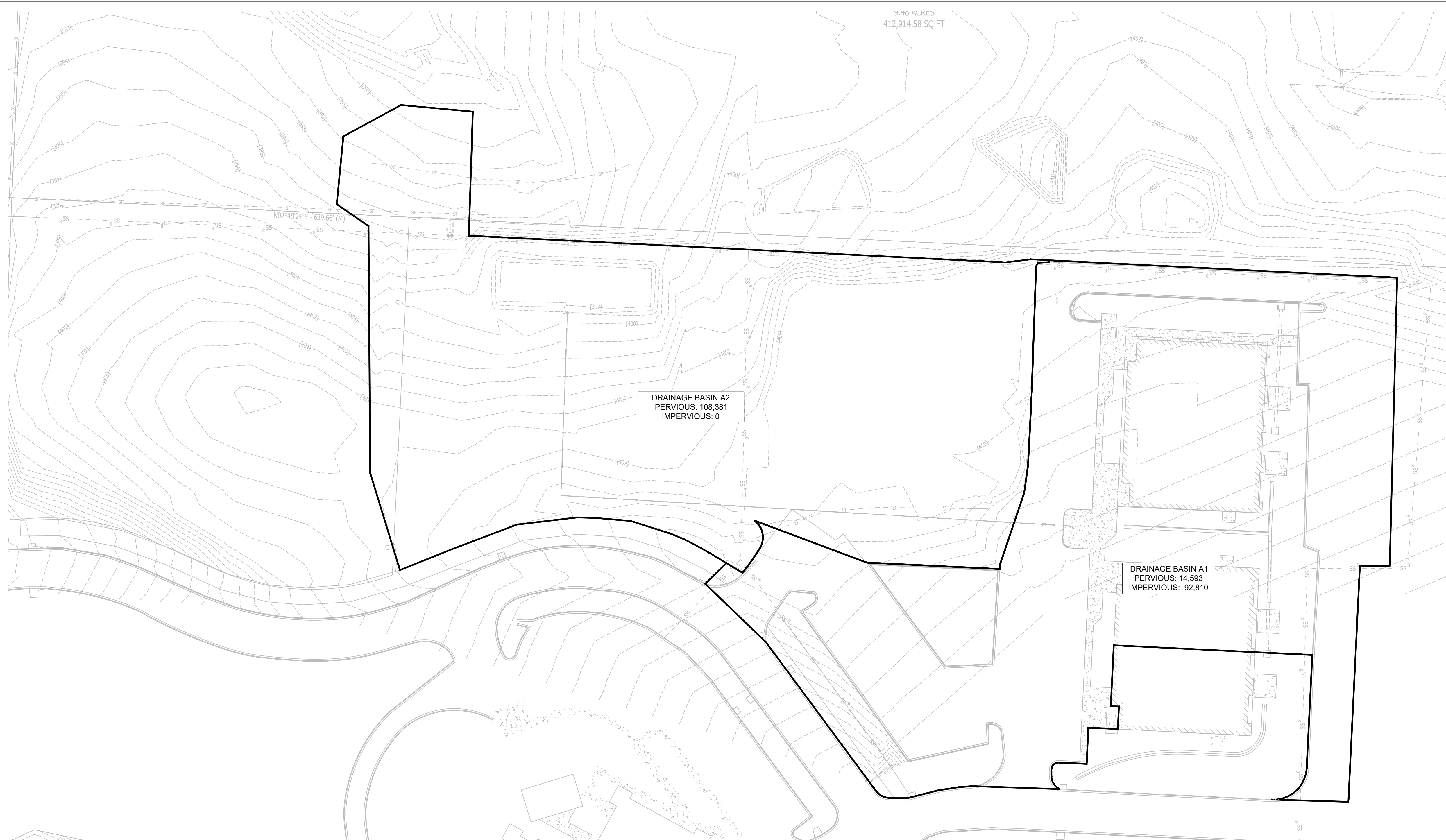

3.40 ALKED
412,914.58 SQ FT

DRAINAGE BASIN A2
PERVIOUS: 108,381
IMPERVIOUS: 0

DRAINAGE BASIN A1
PERVIOUS: 14,593
IMPERVIOUS: 92,810

PRE DRAINAGE MAP

SCALE 1" = 40'

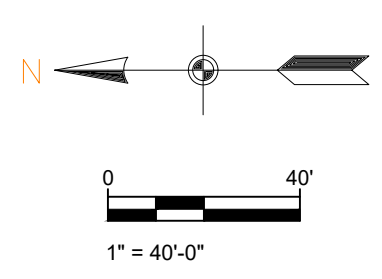

PHILLIP LEWIS ENGINEERING, INC.
Structural + Civil Consultants
23620 Interstate 30 | Bryant, Arkansas
PH: 501-350-9840

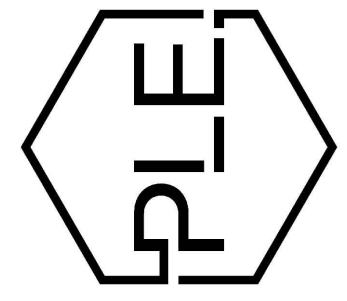

REVISION:

**SUMMERWOOD SPORTS
GYMNASIUM #3**
7817 Hwy 5 N
Bryant, Arkansas

PRELIMINARY
NOT FOR CONSTRUCTION

PROJECT NUMBER:

SHEET ISSUE DATE:
12/12/2023

PAGE TITLE:

PRE DRAINAGE
MAP

SHEET NUMBER:

C1.5

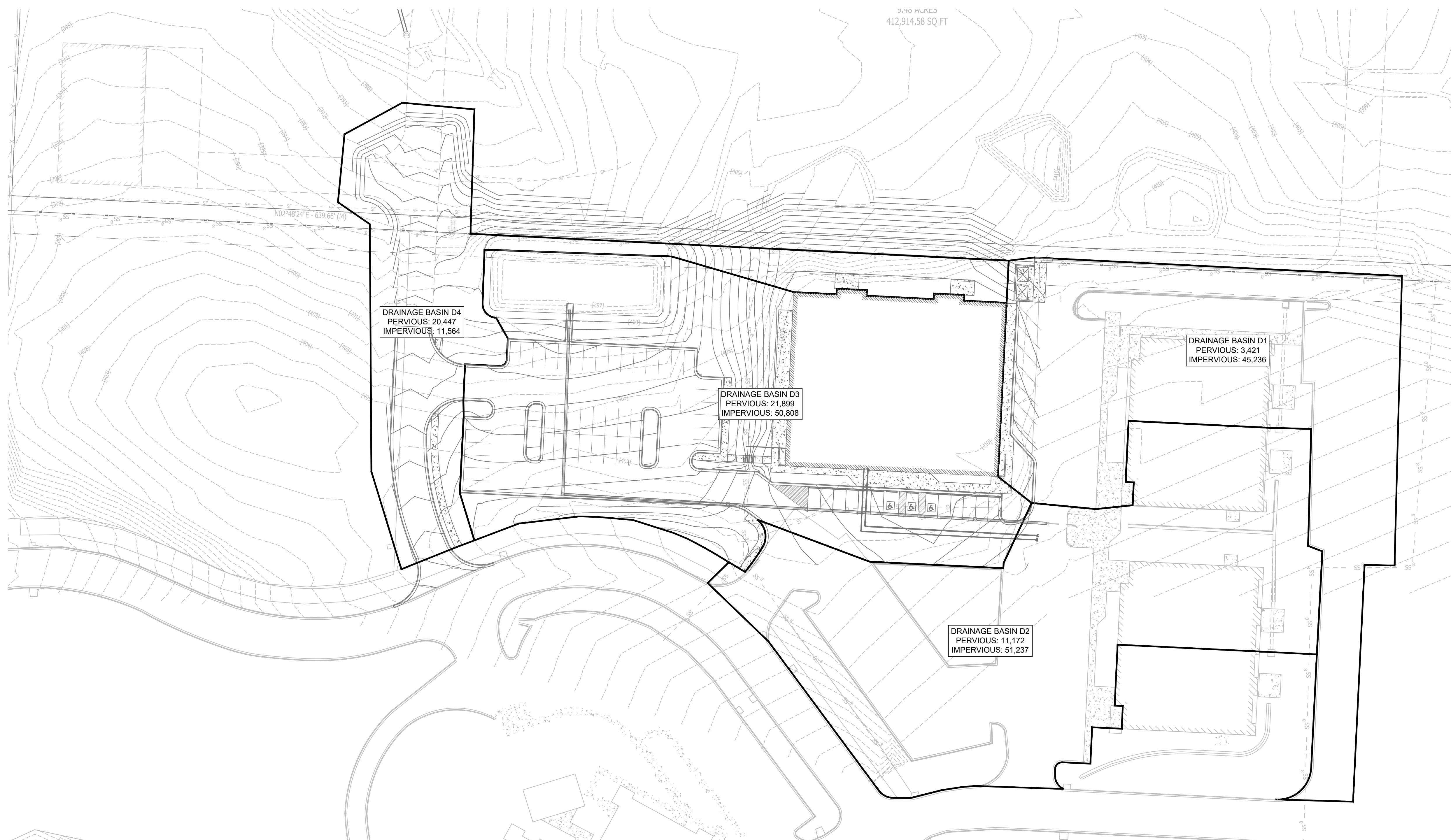

POST DRAINAGE MAP

SCALE 1" = 40'

PHILLIP LEWIS ENGINEERING, INC.
 Structural + Civil Consultants
 23620 Interstate 30 | Bryant, Arkansas
 PH: 501-350-9840

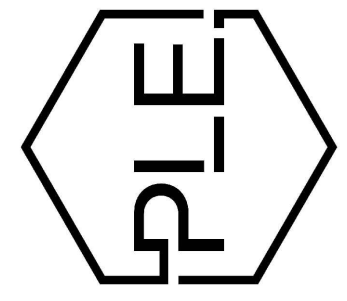

REVISION:

SUMMERWOOD SPORTS GYMNASIUM #3
 7817 Hwy 5 N
 Bryant, Arkansas

PRELIMINARY
 NOT FOR CONSTRUCTION

PROJECT NUMBER:
 SHEET ISSUE DATE: 12/12/2023
 PAGE TITLE:
 POST DRAINAGE MAP
 SHEET NUMBER:
C1.6

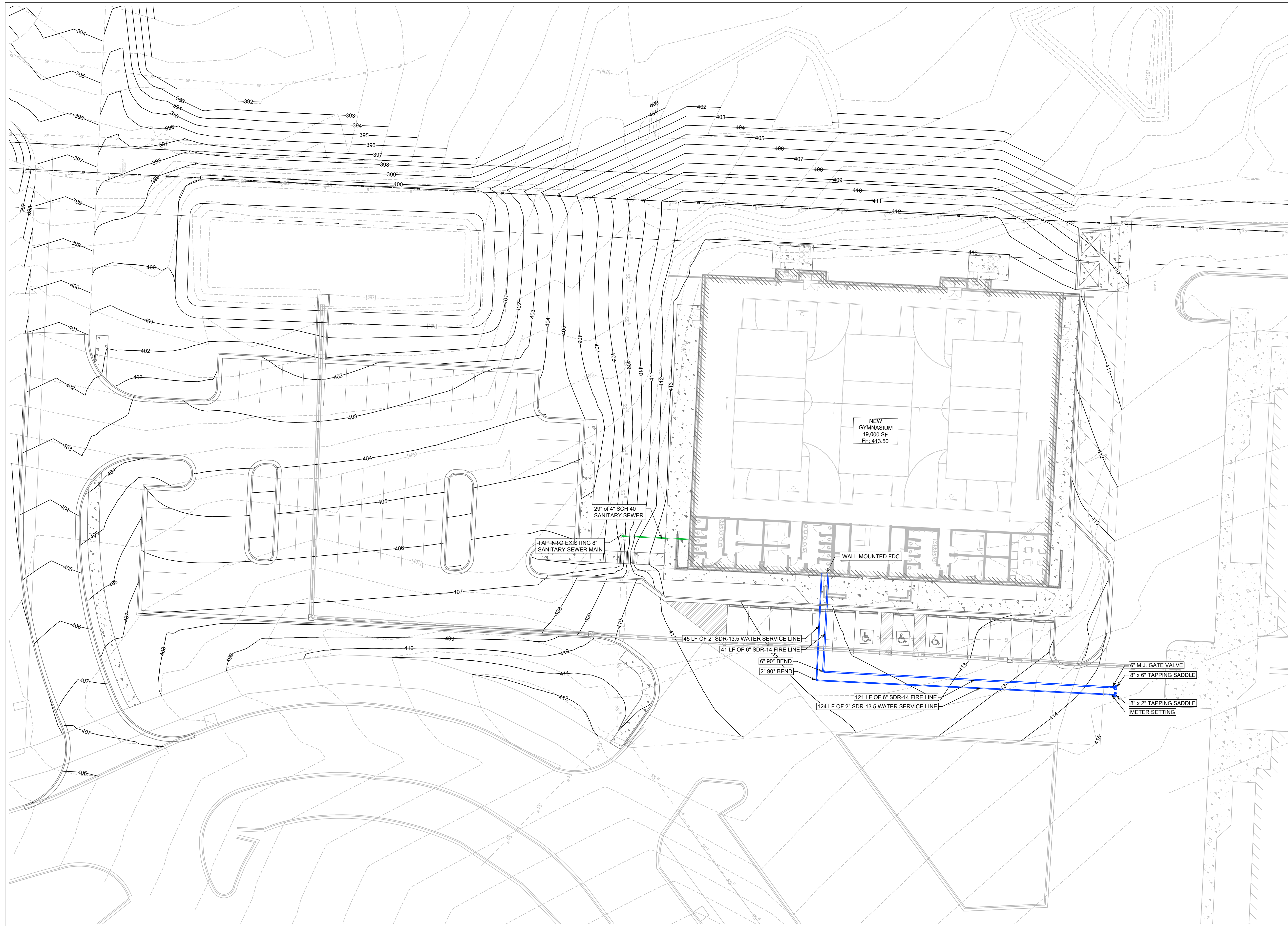

UTILITY PLAN

SCALE 1" = 20'

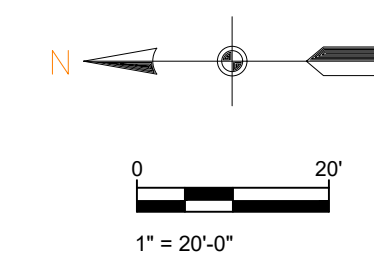

GENERAL CONSTRUCTION NOTES

- THE CONTRACTOR WILL BE HELD SOLELY RESPONSIBLE FOR DAMAGES OCCURRING TO ANY PROPERTY DURING THE CONSTRUCTION OF THIS PROJECT. SAID CONTRACTOR SHALL TAKE ALL NECESSARY PRECAUTIONS TO PREVENT PROPERTY DAMAGE.
- IN ACCORDANCE WITH GENERALLY ACCEPTED CONSTRUCTION PRACTICES, THE CONTRACTOR WILL SOLELY AND COMPLETELY BE RESPONSIBLE FOR CONDITIONS OF THE JOB SITE, INCLUDING SAFETY WORK. THIS REQUIREMENT WILL APPLY CONTINUOUSLY AND WILL NOT BE LIMITED TO NORMAL WORKING HOURS.
- THE DUTY OF BRYANT UTILITIES TO CONDUCT CONSTRUCTION INSPECTION REVIEWS OF THE CONTRACTOR'S PERFORMANCE IS NOT AN INSPECTION OR REVIEW OF THE ADEQUACY OF THE CONTRACTOR'S SAFETY MEASURES IN, ON, OR NEAR THE CONSTRUCTION SITE.
- ALL WATER AND SEWER IMPROVEMENTS SHALL BE CONSTRUCTED IN ACCORDANCE WITH THE LATEST REVISION TO THE CITY OF BRYANT'S WATER AND WASTEWATER (SANITARY SEWER) STANDARD SPECIFICATIONS.
- THE CONTRACTOR IS SPECIFICALLY CAUTIONED THAT THE LOCATION AND/OR ELEVATION OF EXISTING UTILITIES AS SHOWN ON THESE PLANS IS BASED ON RECORDS OF THE VARIOUS UTILITY COMPANIES AND, WHERE POSSIBLE, MEASUREMENTS TAKEN IN THE FIELD. THE INFORMATION IS NOT TO BE RELIED ON AS BEING EXACT OR COMPLETE. THE CONTRACTOR MUST CALL THE APPROPRIATE UTILITY COMPANY AT LEAST 48 HOURS BEFORE ANY EXCAVATION TO REQUEST EXACT FIELD LOCATION OF ALL UTILITIES. IT SHALL BE THE RESPONSIBILITY OF THE CONTRACTOR TO LOCATE ALL EXISTING UTILITIES WHICH CONFLICT WITH PROPOSED IMPROVEMENTS SHOWN ON THE PLAN.
- CONTRACTOR IS TO REMOVE AND DISPOSE OF ALL DEBRIS, RUBBISH, AND OTHER MATERIALS RESULTING FROM PREVIOUS AND CURRENT DEMOLITION OPERATIONS. DISPOSAL WILL BE IN ACCORDANCE WITH ALL LOCAL, STATE AND/OR FEDERAL REGULATIONS GOVERNING SUCH OPERATIONS.
- PRIOR TO INSTALLATION OF ANY UTILITIES, THE CONTRACTOR IS TO EXCAVATE, VERIFY AND CALCULATE ALL CROSSINGS AND INFORM ANY AND ALL UTILITIES OF ANY CONFLICTS PRIOR TO CONSTRUCTION.
- CONSTRUCTION SHALL NOT START ON ANY WATER UTILITY TIE-INS UNTIL APPROVAL IS GIVEN BY BRYANT UTILITIES. SAID CONTRACTOR SHALL NOT OPERATE ANY VALVE, HYDRANT, OR WATER UTILITY APPURTENANCE NOR SHALL HE ATTACH TO OR TAP ANY WATER UTILITY MAIN WITHOUT APPROVAL. THE CONTRACTOR SHALL BEAR THE COST AND CONSEQUENCE OF ANY DISRUPTION OF UTILITY OPERATION CAUSED BY CONSTRUCTION.
- FIBER OPTIC CABLE ON AND/OR ADJACENT TO THIS SITE WERE NOT LOCATED BY THE SURVEY AND ARE NOT SHOWN. IT IS THE RESPONSIBILITY OF THE CONTRACTOR TO LOCATE ANY FIBER OPTIC CABLES ASSOCIATED WITH THIS SITE AND TAKE ALL NECESSARY AND REQUIRED PRECAUTIONS TO PROTECT ANY EXISTING FIBER OPTIC CABLES. CONTRACTORS SHALL COORDINATE ALL EFFORTS WITH OWNER OF FIBER OPTIC CABLES OR THEIR DESIGNATED REPRESENTATIVE.
- THE CONTRACTOR IS RESPONSIBLE FOR CONTACTING "ONECALL" SERVICE TO MARK ALL UTILITIES PRIOR TO ANY DEMOLITION, EARTHWORK, OR UTILITY WORK ON THIS SITE.

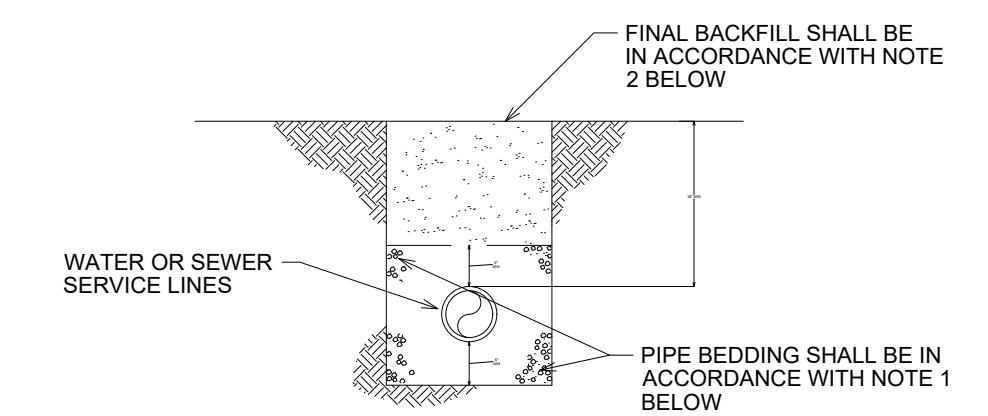

WATER AND SEWER LINES BEDDING DETAIL

NOT TO SCALE

- NOTES:
- BEDDING SHALL BE "GRIT" PER ASTM 2774 OR ASTM D448 SIZE 67 A MINIMUM OF 6" ALL AROUND PIPE.
 - INITIAL BACKFILL NOT UNDER PAVED AREAS CAN BE CLASS III COMPACTED TO 90% STANDARD PROCTOR. ALL BACKFILL UNDER PAVED AREAS SHALL BE CLASS 7 CRUSHED STONE (SB-2) COMPACTED TO 95% STANDARD PROCTOR DENSITY.
 - ALL MATERIALS ARE CLASSIFIED IN ACCORDANCE WITH ASTM D2321-89.
 - ALL MATERIALS SHALL BE INSTALLED IN MAXIMUM 8" LIFTS IN ACCORDANCE WITH ASTM D998. CLASS III AND IV-A MATERIALS SHALL BE COMPACTED TO NEAR OPTIMUM MOISTURE CONTENT.
 - FILL SALVAGED FROM EXCAVATION SHALL BE FREE OF DEBRIS, ORGANICS, AND ROCKS LARGER THAN 3".
 - ALL TRENCH EXCAVATIONS SHALL BE SLOPED, SHORED, SHEETED, BRACED, OR OTHERWISE SUPPORTED IN COMPLIANCE WITH OSHA REGULATIONS AND LOCAL ORDINANCES.

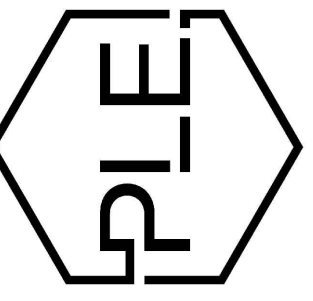

REVISION:

PRELIMINARY
NOT FOR CONSTRUCTION

PROJECT NUMBER:

SHEET ISSUE DATE:
12/12/2023

PAGE TITLE:

UTILITY PLAN

SHEET NUMBER:

C1.7

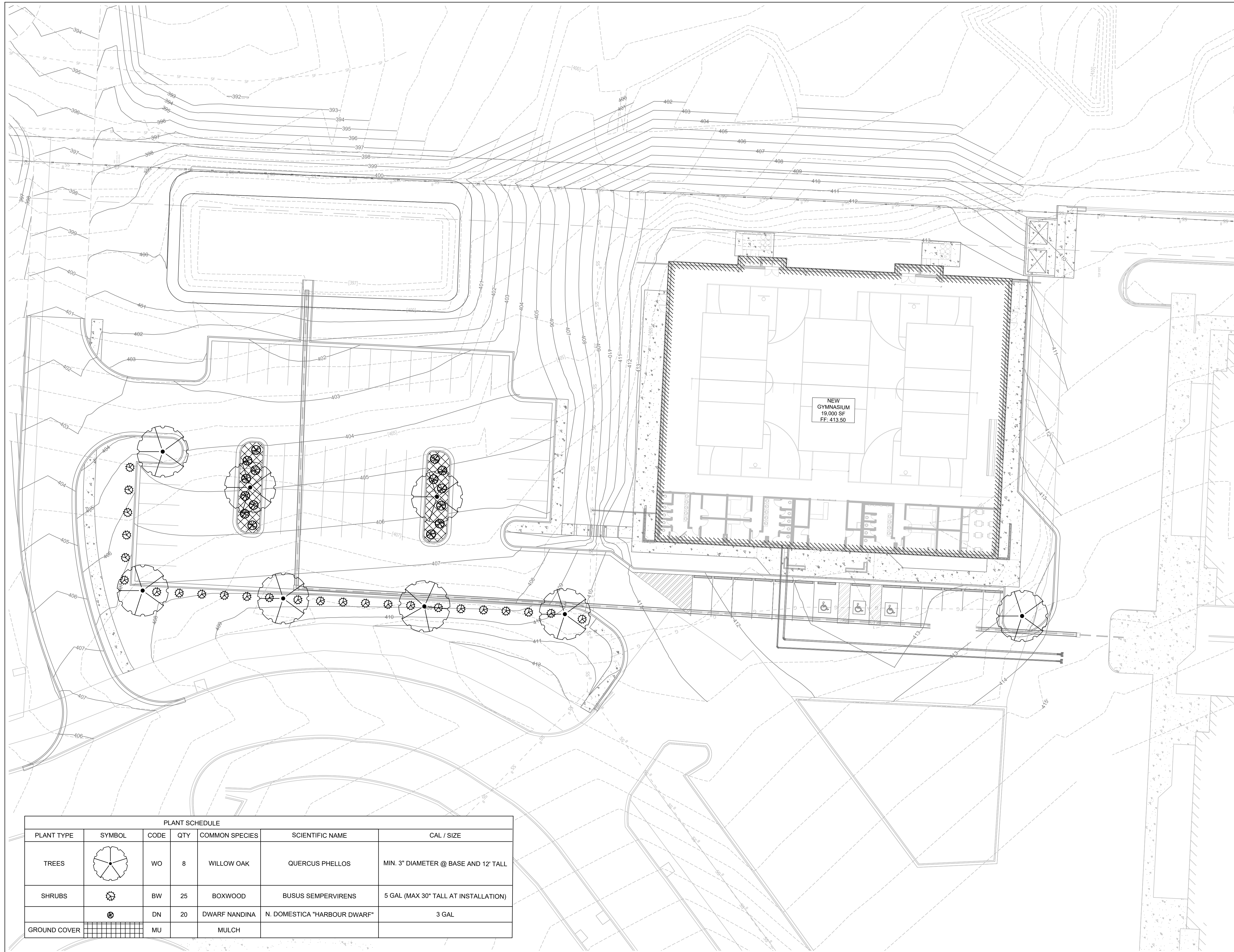

PLANT SCHEDULE						
PLANT TYPE	SYMBOL	CODE	QTY	COMMON SPECIES	SCIENTIFIC NAME	CAL / SIZE
TREES		WO	8	WILLOW OAK	QUERCUS PHELLOS	MIN. 3" DIAMETER @ BASE AND 12' TALL
SHRUBS		BW	25	BOXWOOD	BUSUS SEMPERVIRENS	5 GAL (MAX 30" TALL AT INSTALLATION)
		DN	20	DWARF NANDINA	N. DOMESTICA "HARBOUR DWARF"	3 GAL
GROUND COVER		MU		MULCH		

LANDSCAPING PLAN

THE ABOVE SPECIES IS OPTIONAL IF OWNER WANTS TO GO WITH THE SAME SPECIES AS ADJACENT PROPERTY

SCALE 1" = 20'

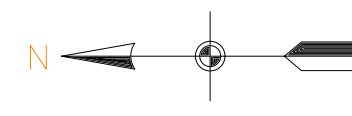

0 20'
1" = 20'-0"

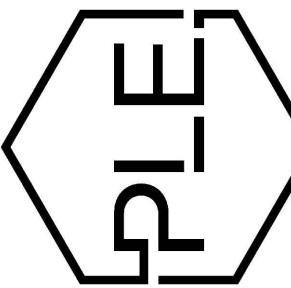

REVISION:

SUMMERWOOD SPORTS GYMNASIUM #3

7817 Hwy 5 N
Bryant, Arkansas

PRELIMINARY
NOT FOR CONSTRUCTION

PROJECT NUMBER:

SHEET ISSUE DATE:
12/12/2023

PAGE TITLE:

LANDSCAPING
PLAN

SHEET NUMBER:



C1.8



SWPPP PH. 1

SCALE 1" = 50'

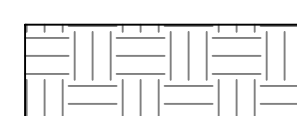
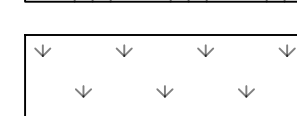
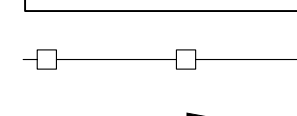
LEGEND

-  DISTURBED AREA
-  UNDISTURBED AREA
-  GRASS SEED
-  SEDIMENT FENCE WITH WIRE BACKING
-  DRAINAGE DIRECTION

NOTES (GENERAL):

1. SEE EROSION CONTROL DETAILS IN SWPPP FOR EROSION CONTROL FACILITIES.
2. SEE SWPPP FOR INSTALLATION, MAINTENANCE, INSPECTION, AND RECORD KEEPING REQUIREMENTS.
3. CONTRACTOR SHALL SHOW EROSION CONTROL MEASURE ON SITE MAP.
4. EROSION AND SEDIMENT CONTROL STRUCTURES TO MEET SWPPP DETAILS - APPENDIX D
5. INSTALL ROCK DITCH, CHECK, OR SAND BAG CHECKS AS NECESSARY TO PREVENT SCOUR UNTIL LANDSCAPING IS ESTABLISHED.
6. CONTRACTOR MUST PLACE SEDIMENT BASIN WITH SEDIMENT FENCE OUTLET FOR ANY SEDIMENT CONTAMINATED DEWATERING DISCHARGE
7. FINAL SLOPE WILL BE SAME DIRECTION AS EXISTING SLOPE.

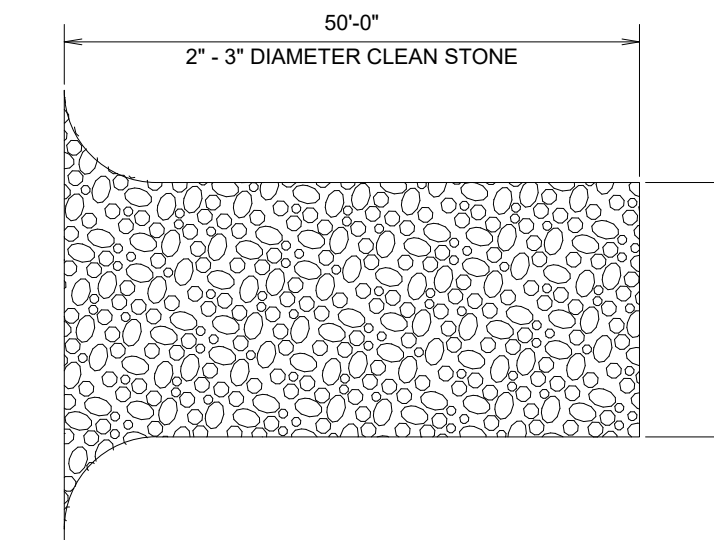
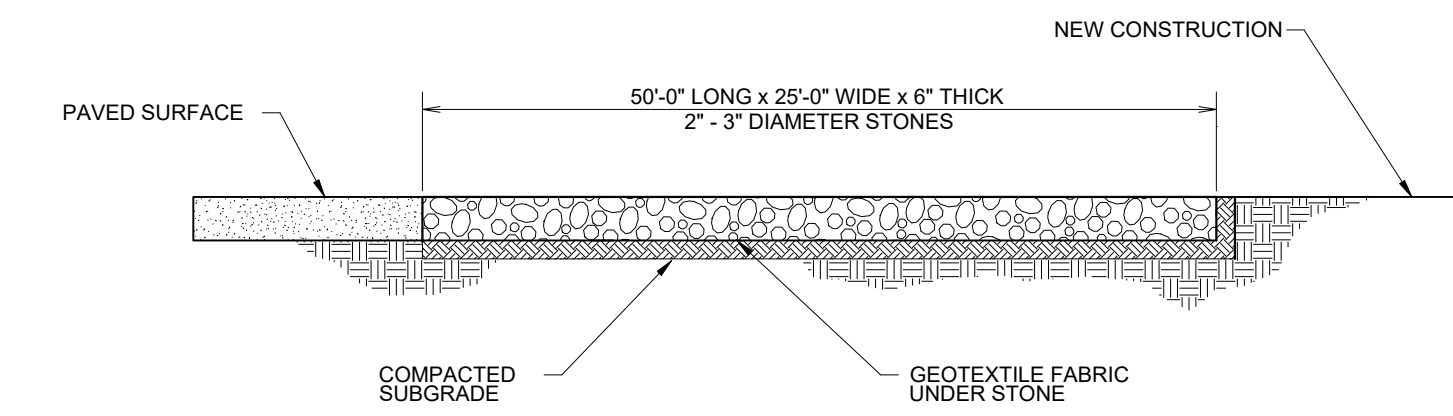

CONSTRUCTION ENTRANCE NOT TO SCALE

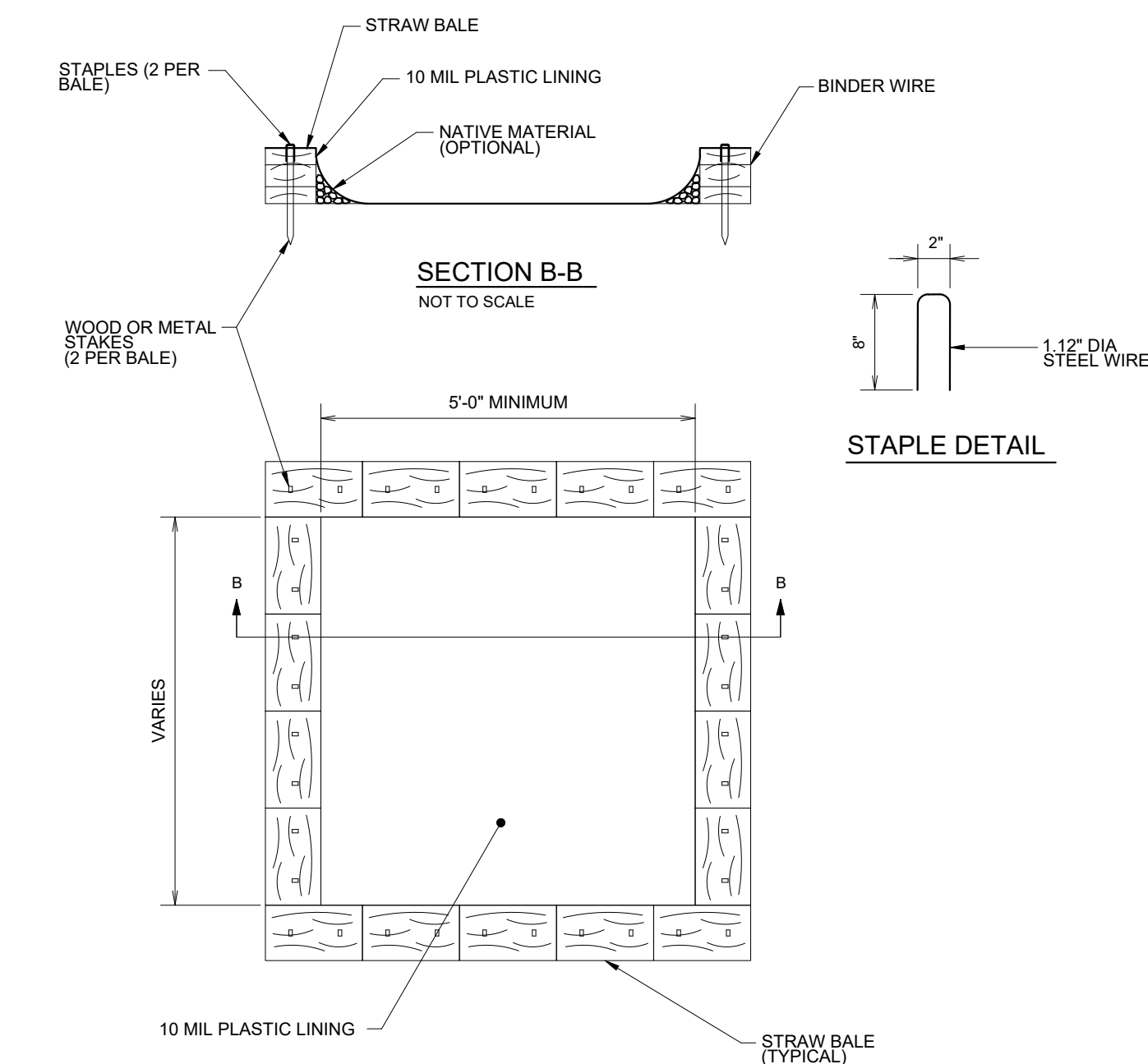

CONCRETE WASHOUT NOT TO SCALE

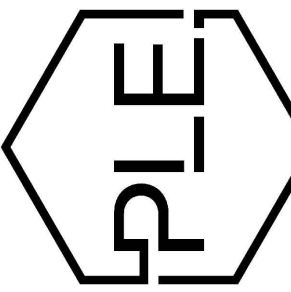
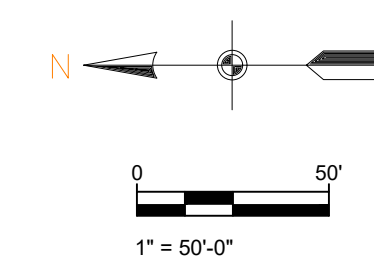

REVISION:

PRELIMINARY
NOT FOR CONSTRUCTION

PROJECT NUMBER:

SHEET ISSUE DATE:
12/12/2023

PAGE TITLE:

SWPPP PH. 1

SHEET NUMBER:



C1.9



SWPPP PH. 2

SCALE 1" = 50'

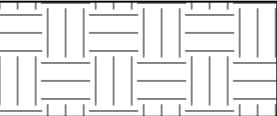
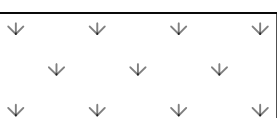
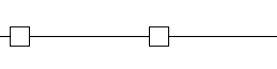
LEGEND

-  DISTURBED AREA
-  UNDISTURBED AREA
-  GRASS SEED
-  SEDIMENT FENCE WITH WIRE BACKING
-  DRAINAGE DIRECTION

NOTES (GENERAL):

1. SEE EROSION CONTROL DETAILS IN SWPPP FOR EROSION CONTROL FACILITIES.
2. SEE SWPPP FOR INSTALLATION, MAINTENANCE, INSPECTION, AND RECORD KEEPING REQUIREMENTS.
3. CONTRACTOR SHALL SHOW EROSION CONTROL MEASURE ON SITE MAP.
4. EROSION AND SEDIMENT CONTROL STRUCTURES TO MEET SWPPP DETAILS - APPENDIX D
5. INSTALL ROCK DITCH, CHECK, OR SAND BAG CHECKS AS NECESSARY TO PREVENT SCOUR UNTIL LANDSCAPING IS ESTABLISHED.
6. CONTRACTOR MUST PLACE SEDIMENT BASIN WITH SEDIMENT FENCE OUTLET FOR ANY SEDIMENT CONTAMINATED DEWATERING DISCHARGE
7. FINAL SLOPE WILL BE SAME DIRECTION AS EXISTING SLOPE.

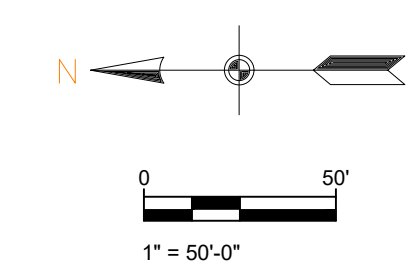

PHILLIP LEWIS ENGINEERING, INC.
Structural + Civil Consultants
23620 Interstate 30 | Bryant, Arkansas
PH: 501-350-9840

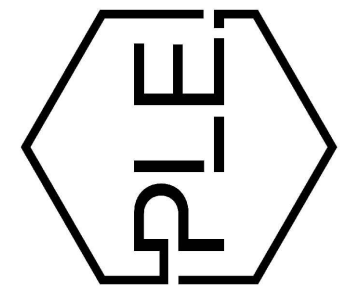

REVISION:

SUMMERWOOD SPORTS GYMNASIUM #3
7817 Hwy 5 N
Bryant, Arkansas

PRELIMINARY
NOT FOR CONSTRUCTION

PROJECT NUMBER:

SHEET ISSUE DATE: 12/12/2023

PAGE TITLE: SWPPP PH. 2

SHEET NUMBER: C1.10

DEEDED LEGAL DESCRIPTION:

Part of the Southeast Quarter of the Northeast Quarter and part of the Northeast Quarter of the Northeast Quarter of Section 29, Township 1 South, Range 14 West, City of Bryant, Saline County, Arkansas, more particularly described as follows: Commencing at the Southeast corner of said Southeast Quarter Northeast Quarter; thence North 02 deg. 25 min. 15 sec. East along the East line thereof for 996.18 feet to the Point of Beginning being on the North right-of-way line of the Springhill Overpass extension road; thence North 70 deg. 09 min. 58 sec. West for 74.13 feet; thence North 80 deg. 18 min. 33 sec. West for 132.10 feet; thence North 77 deg. 52 min. 35 sec. West for 75.62 feet; thence North 02 deg. 25 min. 53 sec. East for 468.89 feet to the South right-of-way line of Interstate #30; thence North 69 deg. 26 min. 48 sec. East for 300.00 feet to the East line of said Northeast Quarter Northeast Quarter; thence South 02 deg. 25 min. 09 sec. West for 637.63 feet to the Point of Beginning, containing 3.49 acres, more or less

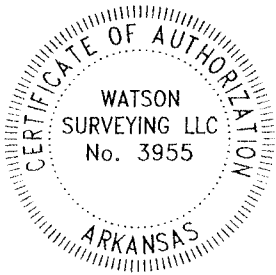
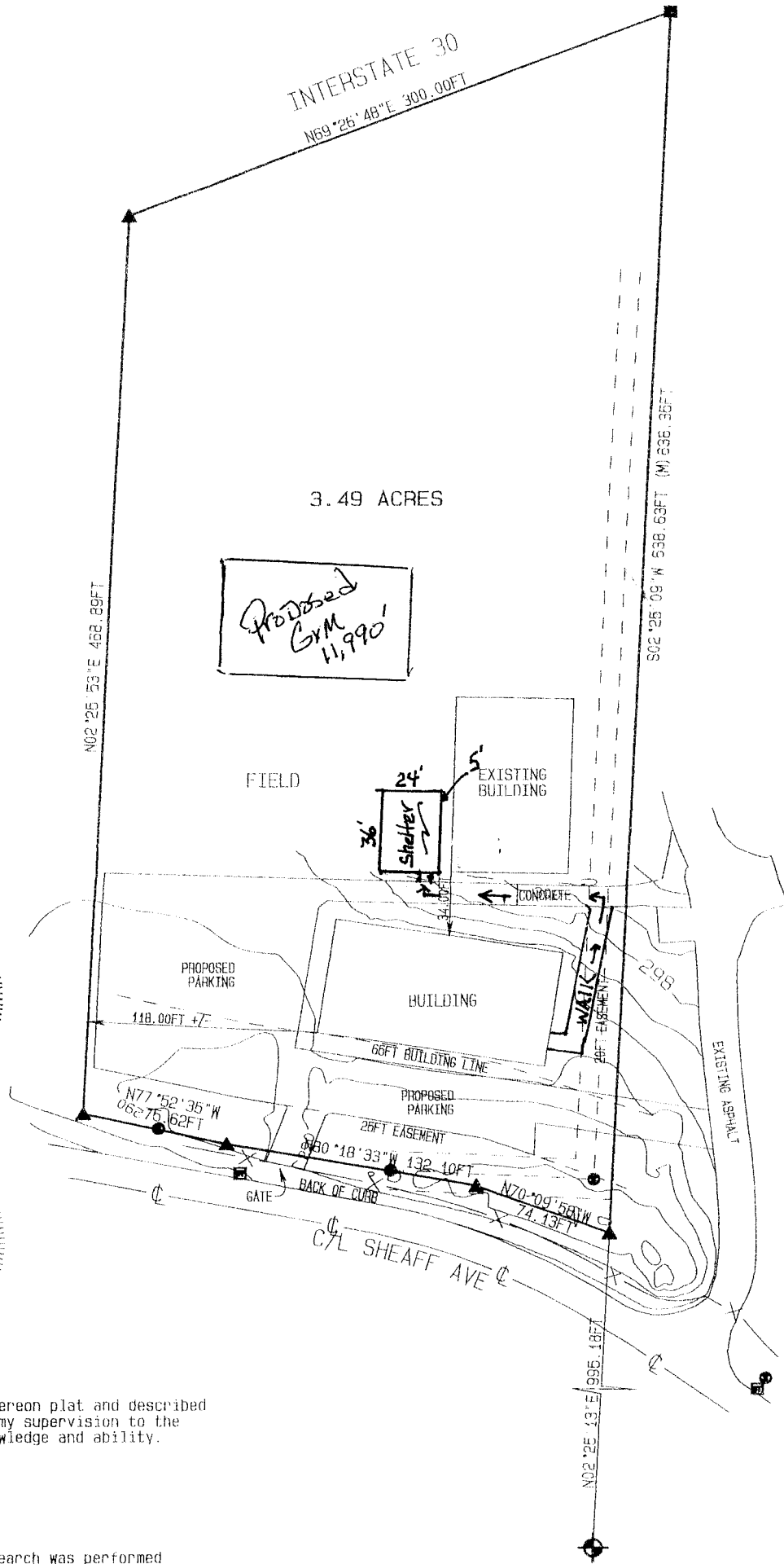

I hereby certify that the hereon plat and described survey was completed under my supervision to the best of my professional knowledge and ability.

Brian J. Watson
BRIAN J. WATSON
P.L.S. #1864

No investigation or other search was performed for easements or other records that an accurate and current title search may disclose

DATE: 27 JULY 2023
SCALE: 1IN. = 70FT.
JOB#23-134
DRAWN BY: BW

**PLOT PLAN
FOR THE USE AND BENEFIT OF
DESTINED TO WIN**



BEARINGS BASED ON EAST LINE FROM ORIGINAL DEED

SCALE 1" = 70'

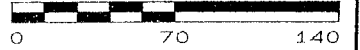

Symbol	Description
☐	STORM DRAIN
⊙	SEWER
▲	COMPUTED
■	REBAR
—X—	FENCE (X) LINE
—C—	CENTER LINE
---	PROPERTY LINE



Building Code Requirements

2012 International Building Code (IBC)

OCCUPANCY TYPE:	TYPE E
BUILDING CONSTRUCTION:	TYPE III
CONSTRUCTION:	UNSPRINKLERED
ALLOWABLE SQ. FT.:	14,500 SQ. FT.
ACTUAL BUILDING SQ. FT.:	864 SQ. FT.
NET AREA:	748 SQ. FT.
ALLOWABLE HEIGHT:	2 STORIES, 55'-0"
ACTUAL HEIGHT:	1 STORY, 14'-8"
EXITS:	
TRAVEL DISTANCE (UNSPRINKLERED)	200
ACTUAL DISTANCE:	38
0.2 WIDTH REQUIRED PER OCCUPANT:	50"
1.5'-0" DOOR REQUIRED, ACTUAL WIDTH:	34"
FIRE EXTINGUISHERS REQUIRED:	1
OCCUPANTS ALLOWED:	5 PER NET SF
748 NET SF	150 OCCUPANTS

DRAWING INDEX

A1.0 FLOOR PLAN, EXTERIOR ELEVATIONS & BUILDING SECTION

- S0.0 GENERAL NOTES
- S0.1 GENERAL NOTES CONTINUED
- S1.1 FOUNDATION & FRAMING PLANS
- S2.1 TYPICAL DETAILS
- S2.2 TYPICAL DETAILS
- S2.3 TYPICAL DETAILS
- S3.1 FRAMING SECTIONS

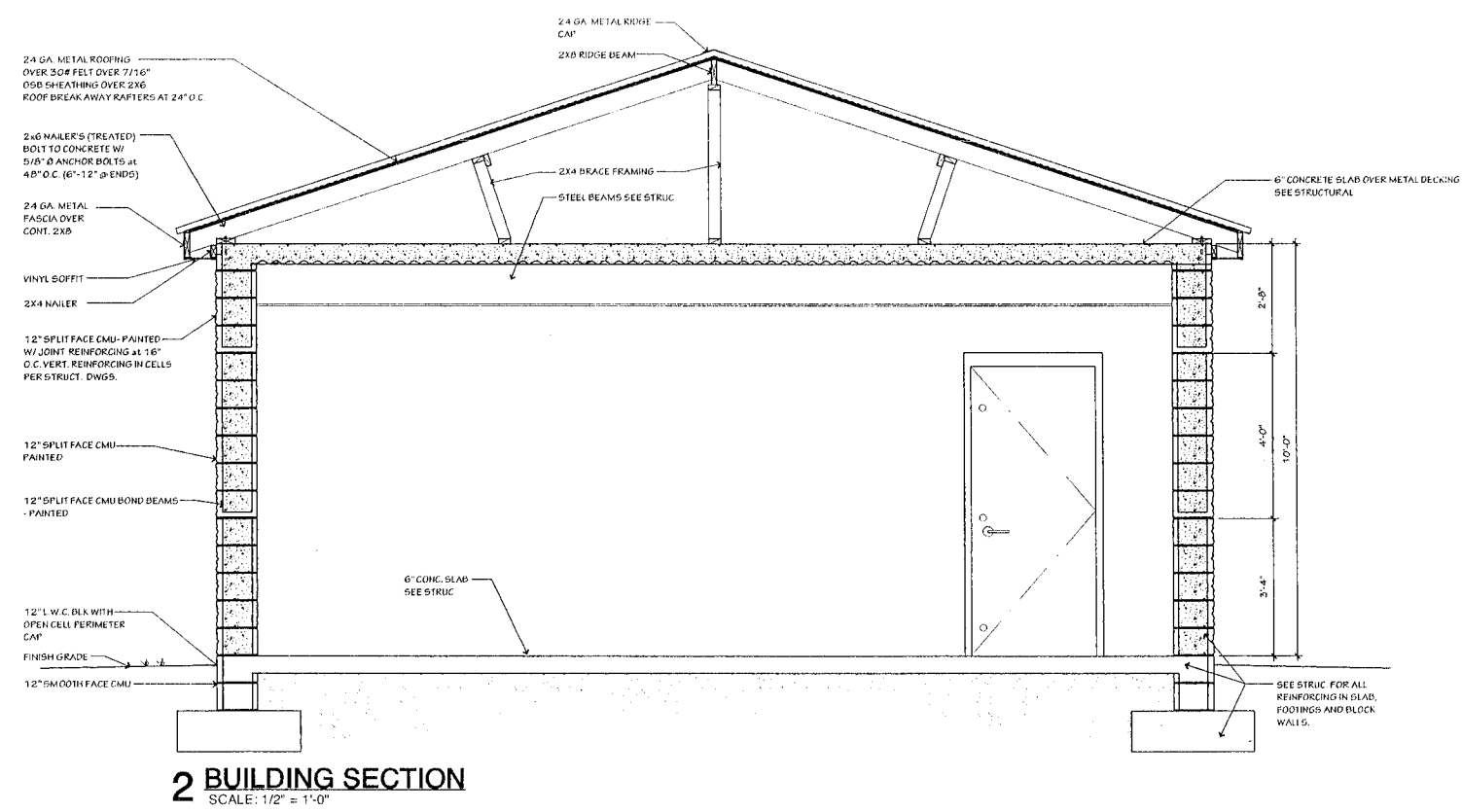
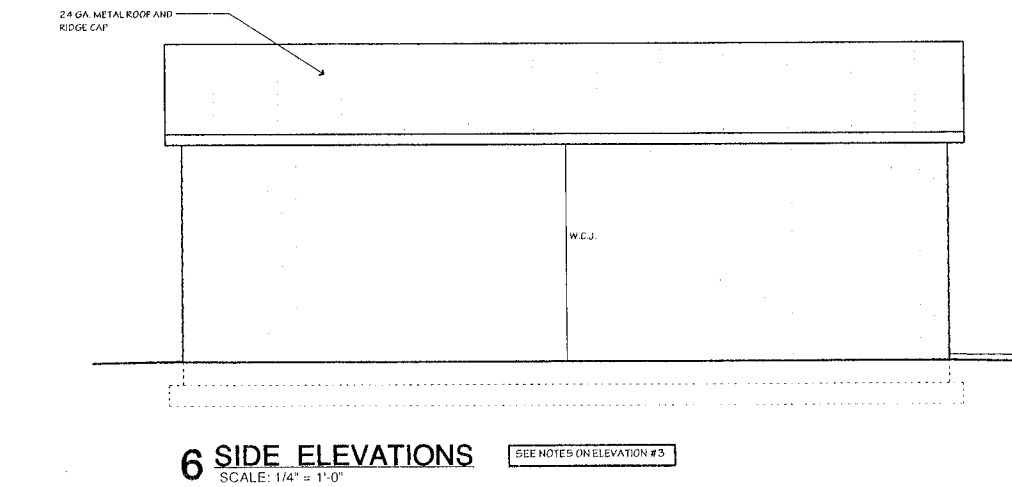
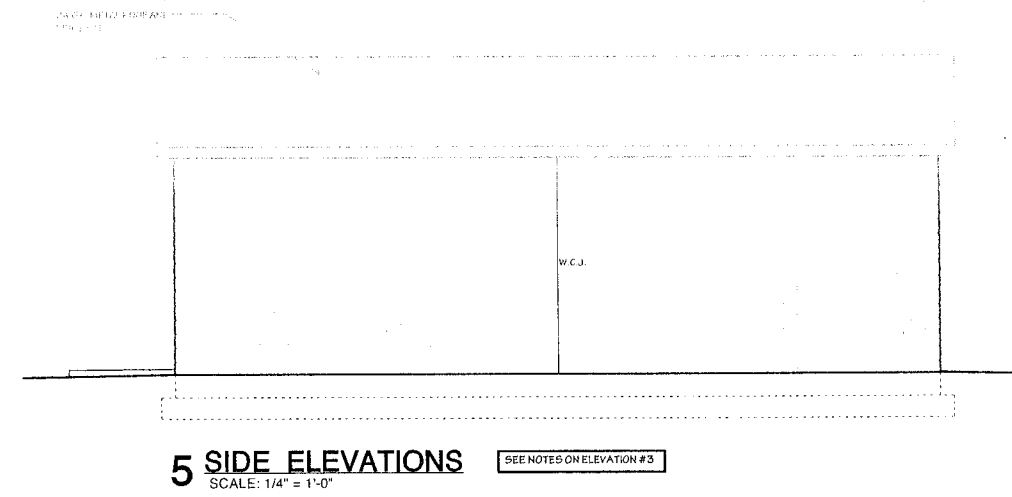
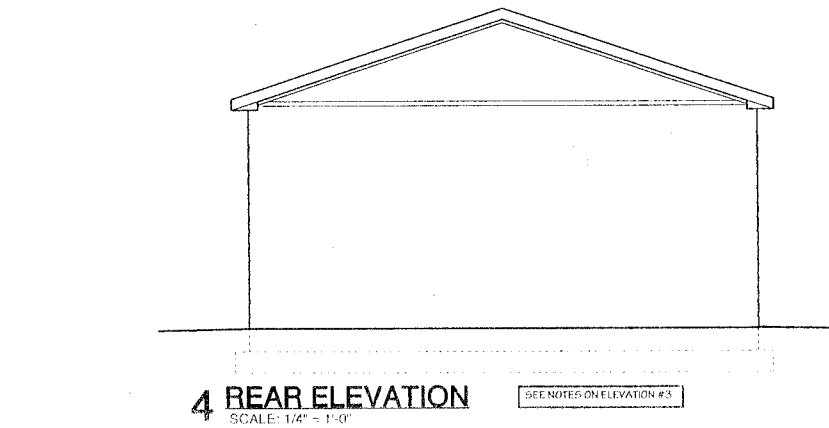
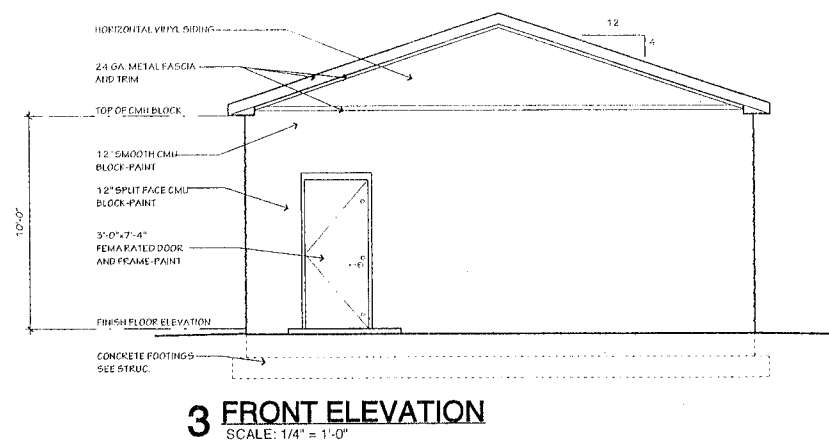
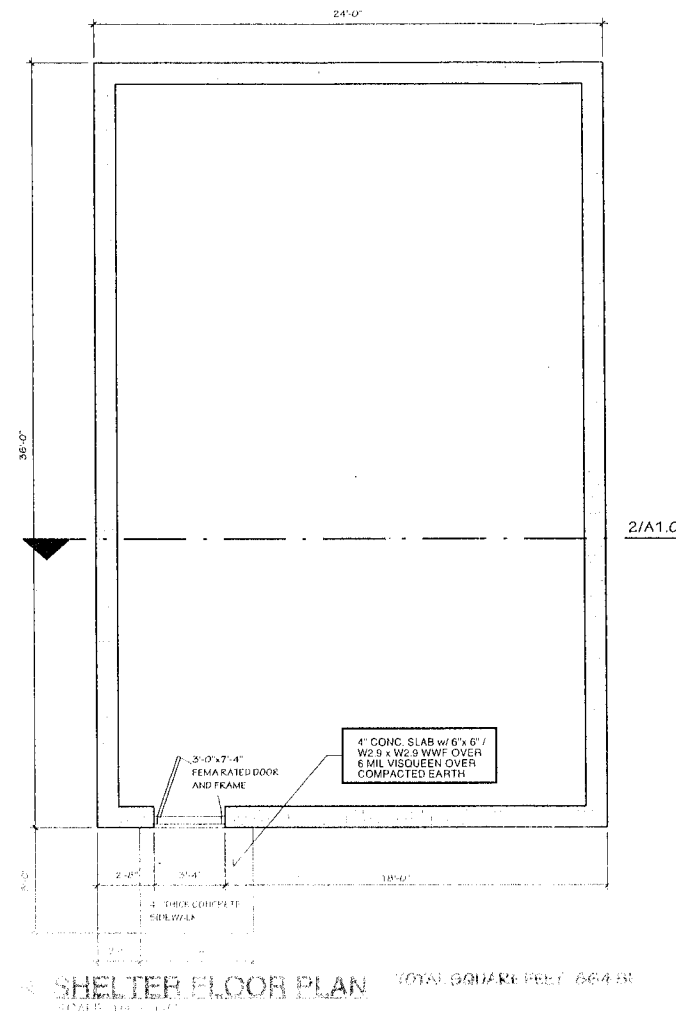

HUGHES ARCHITECTURAL DESIGNS
1202 N STATE LINE AVE
SUITE #102
TEXARKANA, AR 71864
501-627-2448
michae@hughes72s77@gmail.com

New Storm Shelter Facility for
Arkansas Christian Academy
 Bryant, Arkansas

Revisions:

Professional Stamps:

Sheet Title:
Floor Plan, Exterior Elev's & Bldg Section

Date: 12-04-2023
Sheet Number:

A1.0



HUGHES ARCHITECTURAL DESIGNS

1202 N STATE LINE AVE SUITE #102 TEXARKANA, AR 71854 501-627-2448

michal@hughes72477@gmail.com

New Storm Shelter Facility for: Arkansas Christian Academy Bryant, Arkansas

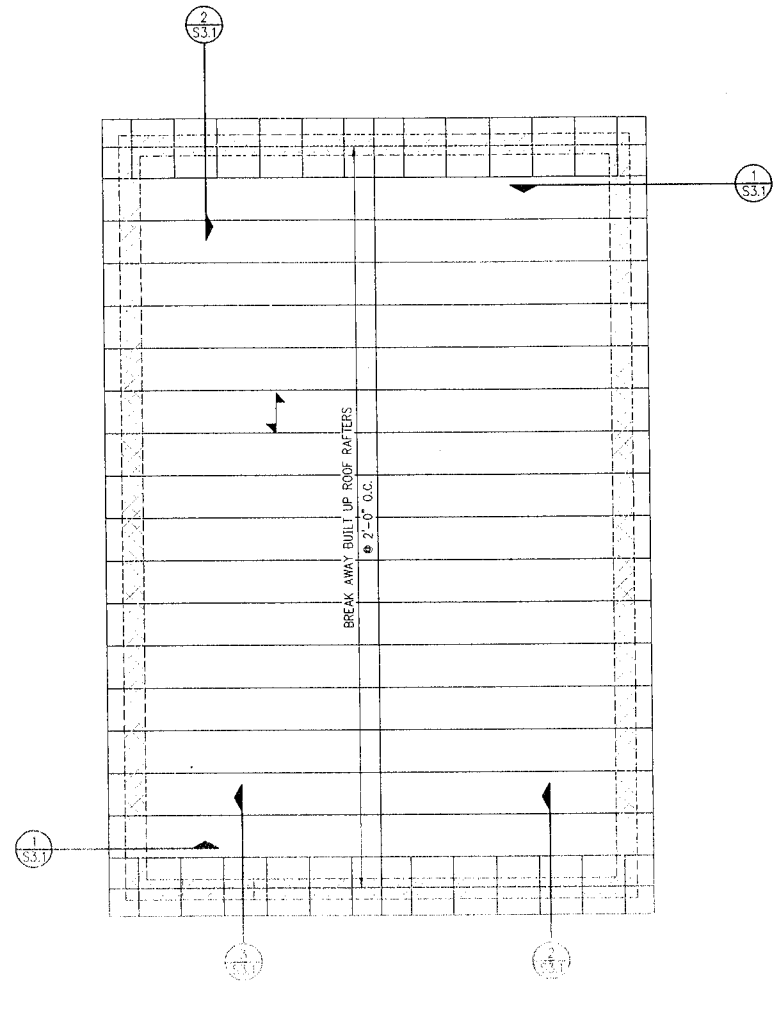
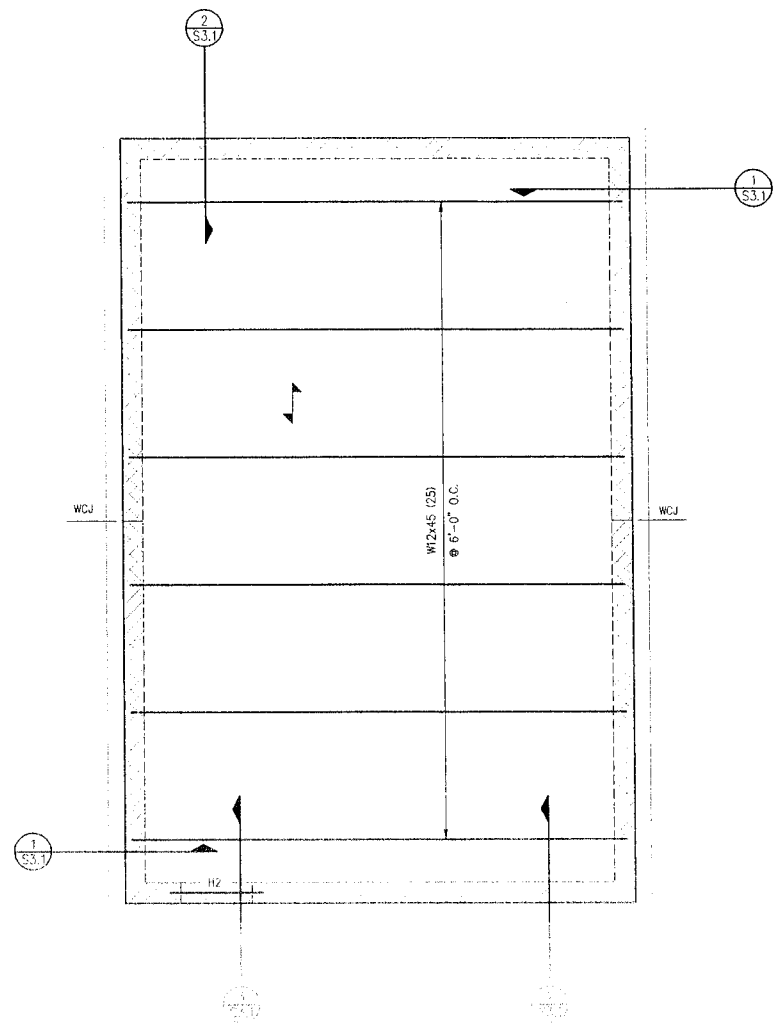
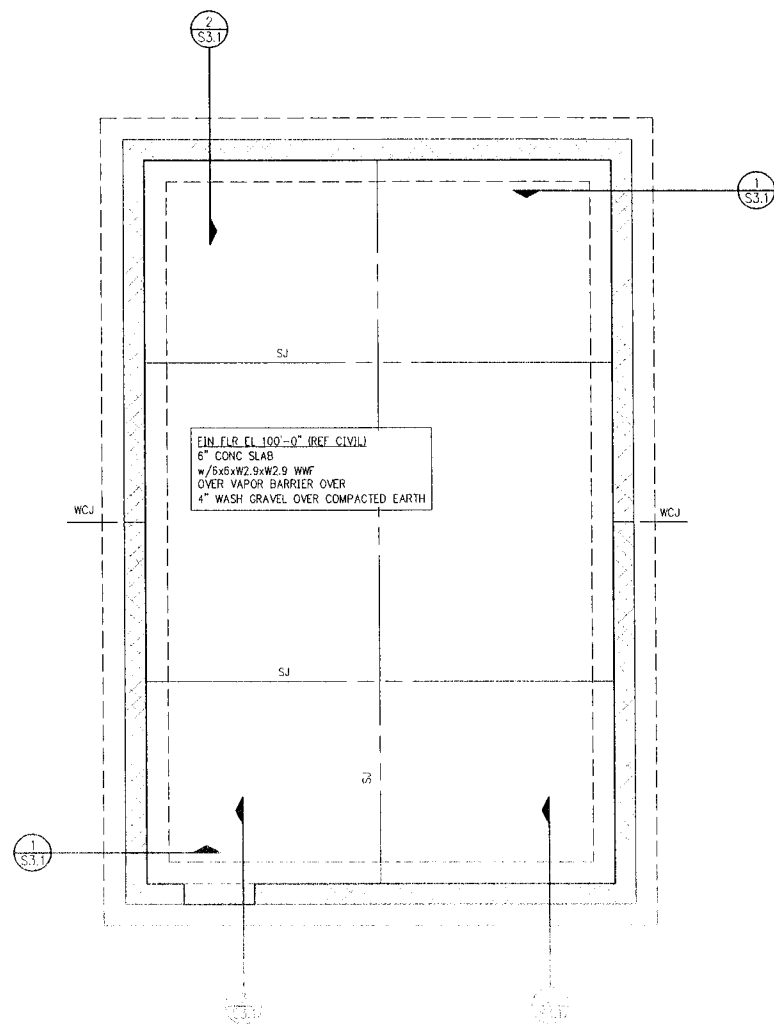

LEGEND:
SJ - SAW JOINT, SEE 1/S2.1
WCJ - MASONRY WALL CONTROL JOINT, SEE 7/S2.1
↔ - DECK SPAN DIRECTION

- MASONRY WALL NOTES:
- STRUCTURAL CONCRETE MASONRY WALLS TO BE NOMINALLY 12" THICK AND REINFORCED FROM FOOTING TO TOP OF WALL UNO. GROUT REINFORCED CELLS SOLID. REINFORCE AND GROUT SOLID CELLS AT CORNERS, OPENING, AND JAMBS AND END OF WALLS. SEE S2.2 FOR TYPICAL DETAILS.
 - DOWEL SPACING TO MATCH VERTICAL REINFORCEMENTS.
 - MASONRY CONTROL JOINT SHALL BE SPACED AT 24' O.C.
 - REINFORCEMENTS DISCONTINUOUS ACROSS CONTROL JOINTS.
 - FOR 12" WALL 2-#5 @ 16" O.C.
 - FOR 12" WALL CORNERS USE 2-#5 THREE CELLS.
 - FOR 12" WALL CONTROL JOINT USE 2-#5 ONE CELL EA SIDE.
 - PROVIDE CONT BOND BEAM AT 4'-0" VERTICAL. ALL MASONRY WALL, BOND BEAMS TO BE REINFORCED WITH 2-#5 CONT.
 - PROVIDE STANDARD HOOK AT THE TOP OF ALL VERTICAL REINFORCEMENT BARS.
 - GROUT SOLID ALL MASONRY BELOW GRADE.

- FOUNDATION PLAN NOTES:
- ALL DIMENSIONS ARE TO BE VERIFIED WITH ARCHITECTURAL DRAWING BEFORE CONSTRUCTION IS TO BEGIN. SEE ARCHITECTURAL DRAWING FOR DIMENSIONS NOT SHOWN. SEE 1/S2.1 FOR SLAB ON GRADE CONSTRUCTION JOINT, CONTROL JOINT, CONTROL JOINT PATTERN TO BE MAXIMUM 15'X15'.
 - PILASTER OR PIERS SHOWN WITHIN CMU WALLS ARE TO EXTEND FROM BEAM/GIRDER BEARING TO TOP OF FTG OR FOUNDATION WALL PILASTER.
 - GENERAL CONTRACTOR TO COORDINATE WITH (MEP) MECHANICAL, ELECTRICAL, AND PLUMBING CONTRACTORS FOR ANY AND ALL LOCATIONS OF SLEEVED OPENINGS IN FOUNDATION WALLS.
 - WHERE SLAB IS SAWCUT FOR INSTALLATION OF NEW PLUMBING/ELECTRICAL WORK PATCH PER DETAIL 4/S2.1.
 - DO NOT BEGIN DEMOLITION OR EXCAVATION WORK UNTIL EXISTING STRUCTURE HAS BEEN ADEQUATELY SHORED TO SUPPORT EVERY LEVEL. SHORING SHALL REMAIN IN PLACE UNTIL ALL NEW STRUCTURAL ELEMENTS SHOWN HAVE BEEN INSTALLED. REFER TO "EXISTING CONSTRUCTION" NOTES ON S.O.F. FOR ADDITIONAL REQUIREMENTS.

1/2" CONC. LID (2S) AT 6" COMPOSITE DECK
1.5" VLI DECK w/4.5" CONCRETE (6" TOTAL)
REINFORCE WITH 6x6xw2.9xw2.9 WWF
DECK FASTENING SHALL BE AS FOLLOWS: ATTACH TO SUPPORTING MEMBER USING #12 TEK SCREWS IN A 3/4" PATTERN.
SIDE LAP SEAMS TO BE FASTENED WITH #12 TEK SCREWS AT 12" O.C.
PERIMETER SUPPORTS TO BE FASTENED TO STRUCTURE WITH #12 TEK SCREWS @ 12" O.C. ALONG THE FULL LENGTH OF PANEL AND AROUND PERIMETER OF OPENINGS UNLESS NOTED OTHERWISE.

- NOTE:
- METAL DECK PANEL PERPENDICULAR TO SUPPORTS.
 - COORDINATE MECHANICAL OPENING SUPPORT WITH ARCHITECT/JOIST MANUFACTURER.
 - JOIST SUPPLIER SPECIFY ADDITIONAL BRACING/BRIDGING.
 - JOIST'S MANUFACTURE SHALL DESIGN JOISTS FOR UPLIFT. SEE COMPONENT AND CLADDING S.O.F.
 - DO NOT BEGIN DEMOLITION OR EXCAVATION WORK UNTIL EXISTING STRUCTURE HAS BEEN ADEQUATELY SHORED TO SUPPORT EVERY LEVEL. SHORING SHALL REMAIN IN PLACE UNTIL ALL NEW STRUCTURAL ELEMENTS SHOWN HAVE BEEN INSTALLED. REFER TO "EXISTING CONSTRUCTION" NOTES ON S.O.F. FOR ADDITIONAL REQUIREMENTS.

LEGEND:
H? - MASONRY HEADER, SEE 3/S2.2
WCJ - MASONRY WALL CONTROL JOINT, SEE 7/S2.1
↔ - DECK SPAN DIRECTION

A FOUNDATION PLAN 1/4"=1'-0"

B CONC LID FRAMING PLAN 1/4"=1'-0"

C ROOF FRAMING PLAN 1/4"=1'-0"

Revisions

Professional stamp:
STATE OF ARKANSAS
REGISTERED PROFESSIONAL ENGINEER
No. 10449
DATE SIGNED: 12-04-2023
FOR 3rd PARTY REVIEW NOT FOR CONSTRUCTION

Sheet Title
Foundation & Framing Plans

Date:
Sheet Number:
S1.1



LIVE OAK ENGINEERING
2509 7TH AVENUE SOUTH BIRMINGHAM, AL 35233 205-637-3115 LOK# 258-1



HUGHES ARCHITECTURAL DESIGNS

1202 N STATE LINE AVE
SUITE #102
TEXARKANA, AR 71854
501-627-2448

micha@hughes72577@gmail.com

New Storm Shelter Facility for:
Arkansas Christian Academy
Bryant, Arkansas

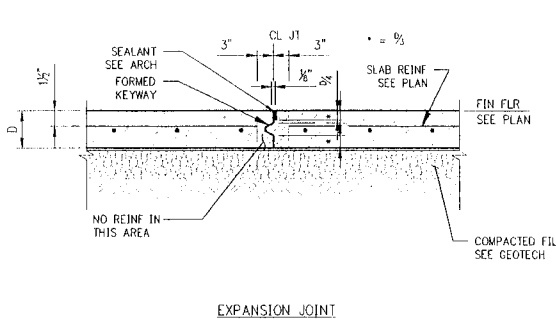

EXPANSION JOINT

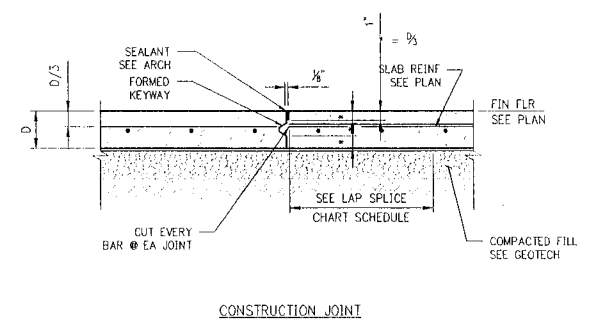

CONSTRUCTION JOINT

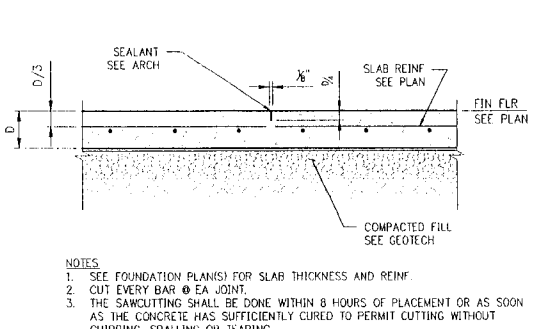

SAWCUT CONTROL JOINT

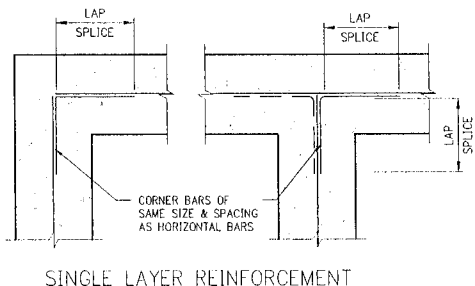

SINGLE LAYER REINFORCEMENT

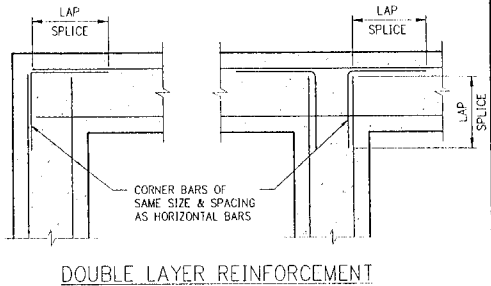

DOUBLE LAYER REINFORCEMENT

NOTES:
1. SEE FOUNDATION PLANS FOR SLAB THICKNESS AND REINF.
2. CUT EVERY BAR @ EA JOINT.
3. THE SAWCUTTING SHALL BE DONE WITHIN 8 HOURS OF PLACEMENT OR AS SOON AS THE CONCRETE HAS SUFFICIENTLY CURED TO PERMIT CUTTING WITHOUT CHIPPING, SPALLING OR TEARING.

NOTE:
ALL LAP SPLICES CLASS "B" TENSION

1 DETAIL-TYP SLAB JOINTS
S2.1 NTS

2 DETAIL - REINFORCING AT CORNERS & INTERSECTIONS
S2.1 NTS

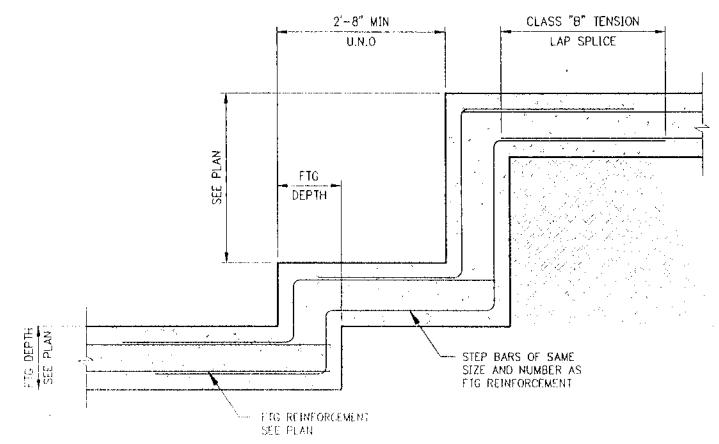

3 DETAIL-STEPPED FOOTING
S2.1

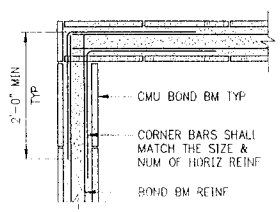

4 DETAIL-TYP BOND BM CORNER REINF
S2.1

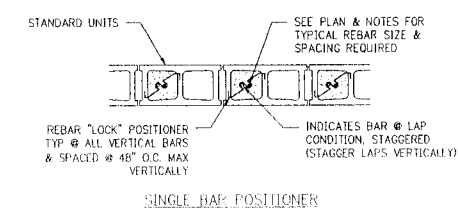

SINGLE BAR POSITIONER

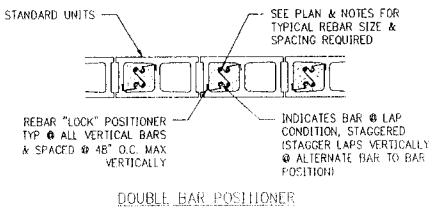

DOUBLE BAR POSITIONER

5 DETAIL-TYP MASONRY WALL REINFORCEMENT POSITIONERS
S2.1

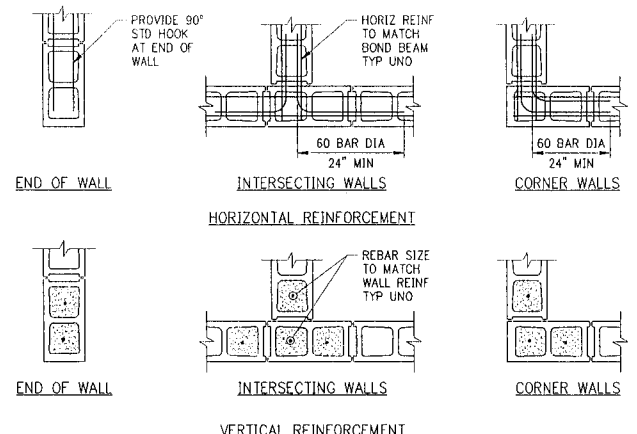

NOTES:
1. REINFORCEMENT SHOWN IS IN ADDITION TO MINIMUM WALL REINFORCEMENT SHOWN IN FOUNDATION DETAILS.
2. REINFORCING TO BE CONTINUOUS FROM FOOTING TO TOP OF WALL. FILL CORES SOLID WITH GROUT AS NOTED IN THE SPECIFICATIONS OR GENERAL NOTES.

6 DETAIL-TYP CMU WALL INTERSECTIONS
S2.1 NTS

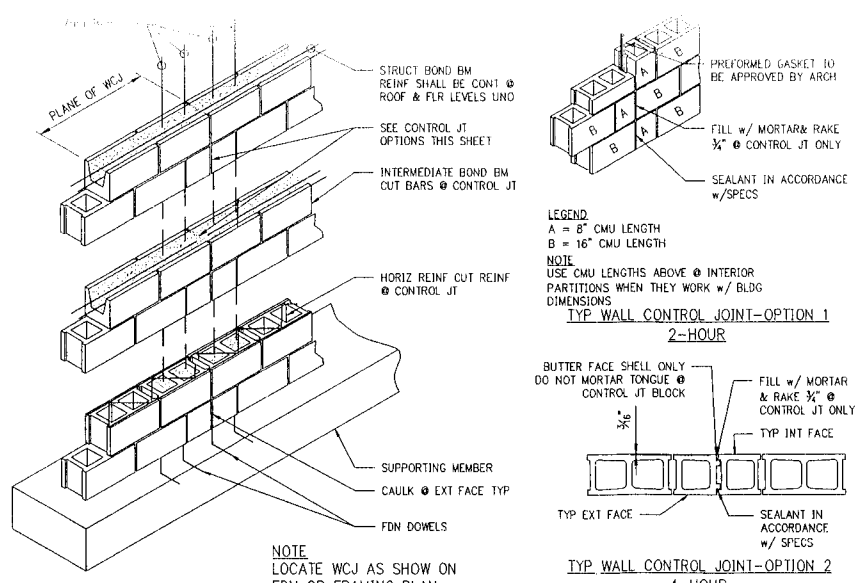

NOTE:
LOCATE WCJ AS SHOW ON FDN OR FRAMING PLAN
MAX 24'-0" SPACING UNO

7 DETAIL-TYP CMU WALL CONTROL JOINT (WCJ)
S2.1 3/4"x1'-0"

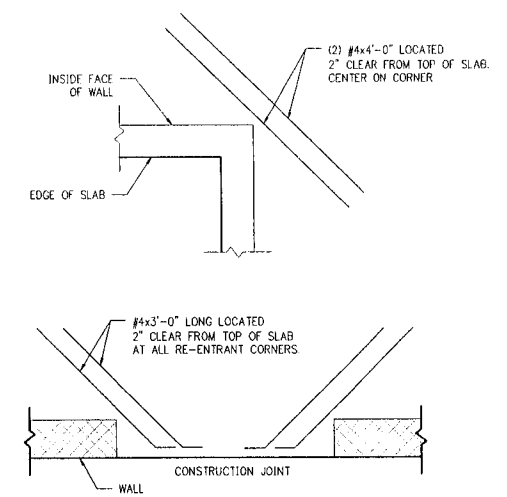

8 DETAIL-TYP RE-ENTRANT CORNER REINF
S2.1 NTS

Revisions

Professional stamp:
STATE OF ARKANSAS
REGISTERED PROFESSIONAL ENGINEER
No. 10449
PARKER M. PLOURDE
DATE SIGNED: 12-04-2023
FOR 3rd PARTY REVIEW NOT FOR CONSTRUCTION

Sheet Title:
Typical Details

Date:
Sheet Number:

S2.1



LIVE OAK ENGINEERING
2509 7TH AVENUE SOUTH
BIRMINGHAM, AL 35233
205.637.3115
LOE# 258-1



**HUGHES
ARCHITECTURAL
DESIGNS**

1202 N STATE LINE AVE
SUITE #102
TEXARKANA, AR 71854
501-627-2448

michal@hughes77277@gmail.com

New Storm Shelter Facility for:
Arkansas Christian Academy
Bryant, Arkansas

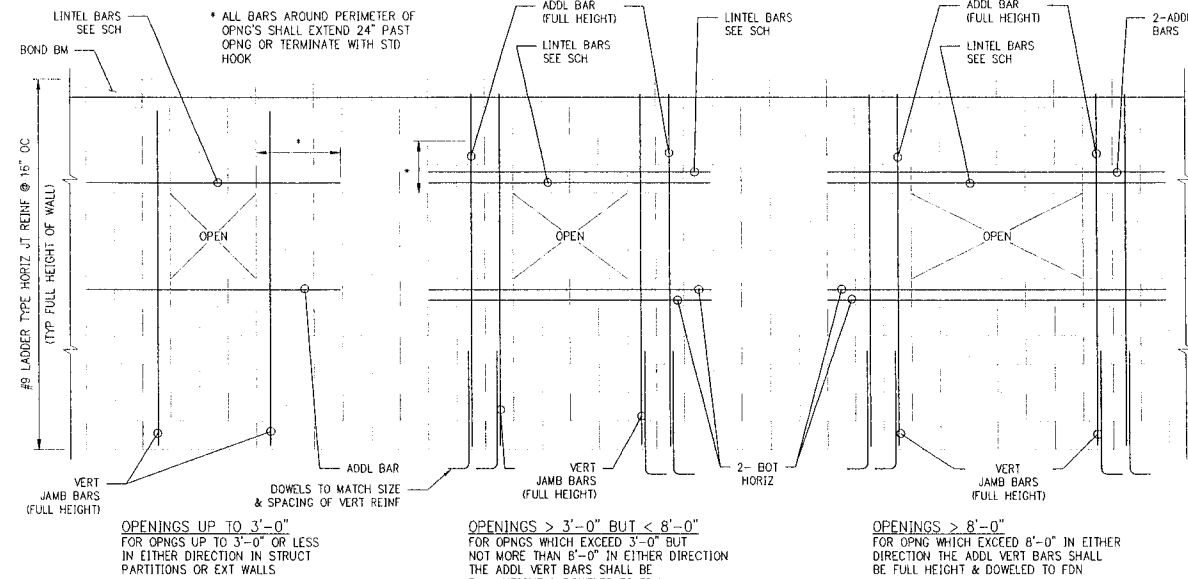

1 **DETAIL-TYP ADDL REINF AROUND WALL OPNGS**
S2.2 NTS

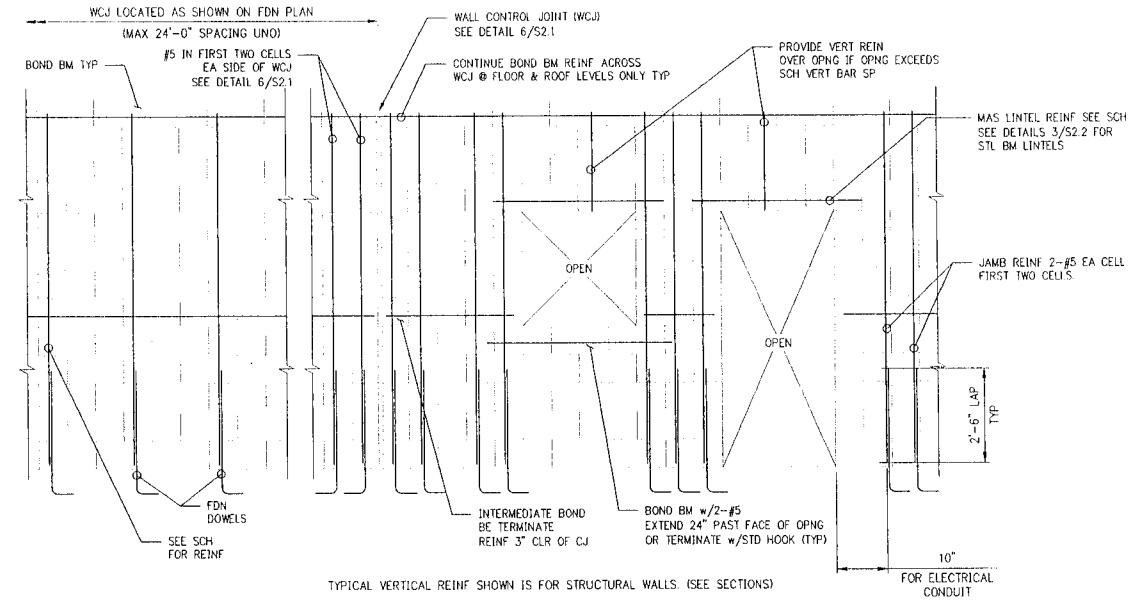

2 **DETAIL-TYP BOND BM, CONTROL JT & WALL REINF**
S2.2 NTS

HEADER SCHEDULE				
MARK	WALL	REINFORCEMENT	SHEAR REINFORCEMENT	REMARKS
H1	8"	2-#5 CONT	N/A	-
	12"	2-#5 CONT	-	-
H2	8"	2-#5 CONT TAB	-	-
	12"	2-#5 CONT TAB	-	-

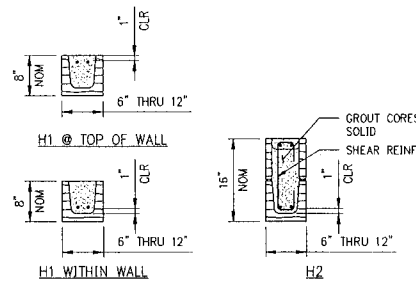

- NOTE**
- SEE STRUCT DWGS FOR GENERAL LOCATION OF HEADERS - SEE ARCH FOR SPECIFIC LOCATION & CLEAR SPAN.
 - LINTELS SHALL SPAN CONT BTWN BRNGS EACH SIDE.
 - PROVIDE 8" (MIN) BRNG FOR CLEAR SPAN 8'-0" OR LESS, 16" (MIN) BRNG FOR CLEAR SPAN GREATER THAN 8'-0".
 - EXTEND BOT REINF TO END OF BRNG EACH SIDE - EXTEND TOP REINF WHERE POSSIBLE - BASIC DEVELOPMENT LENGTH - TERMINATE TOP REINF w/STD HOOK AT CONTROL JTS OR FREE EDGES.
 - PROVIDE SOLID GROUTED OF SOLID MAS JAMB UNDER LINTEL EA SIDE OF OPNG FOR CLEAR SPAN GREATER THAN 8'-0".

3 **DETAIL-MASONRY LINTELS**
S2.2 3/4" = 1'-0"

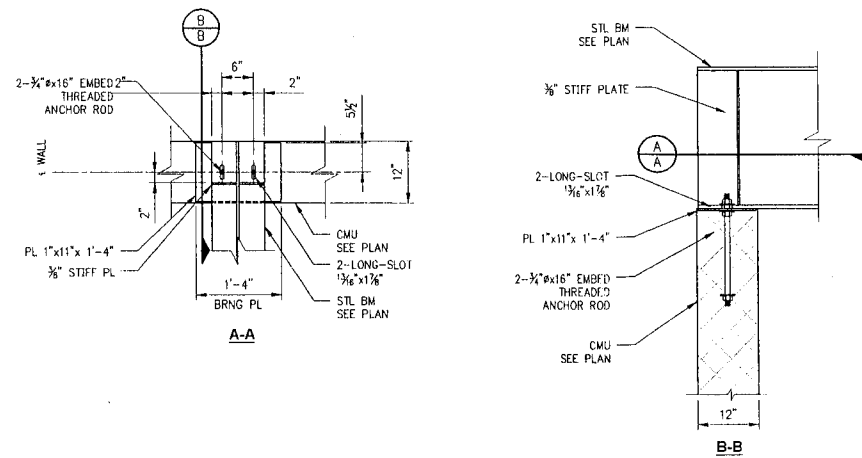

4 **EXTERIOR CORRIDOR BEARING PLATE**
S2.2 3/4" = 1'-0"

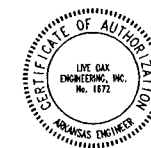

**LIVE OAK
ENGINEERING**
2509 7TH AVENUE SOUTH
BIRMINGHAM, AL 35233
205.637.3116
LOG# 256-1

Revisions

Professional stamp:
STATE OF
ARKANSAS
REGISTERED
PROFESSIONAL
ENGINEER
No. 10449
P. M. PLOUDE
DATE SIGNED:
12-04-2023
FOR 3rd PARTY REVIEW
NOT FOR CONSTRUCTION

Sheet Title:
Typical
Details

Date:
Sheet Number:

S2.2

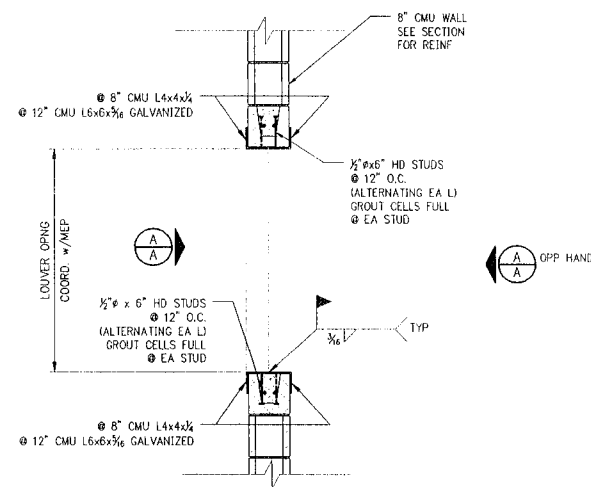

1
S2.3
DETAIL-OPNG IN MASONRY
TORNADO SHELTER WALL
NTS

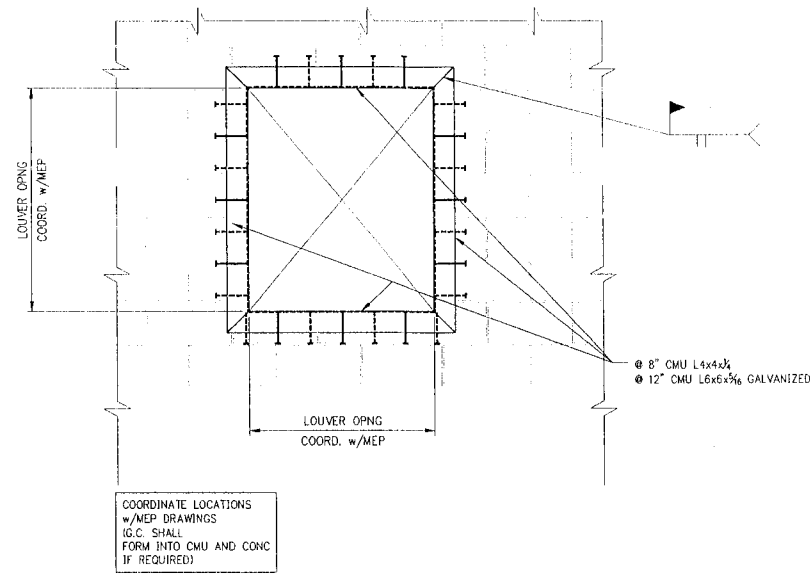

2
S2.3
DETAIL-TYPICAL OPENING THRU ROOF DECK
3/4" = 1'-0"

HEADER SCHEDULE	
JOIST SPACING	SIZE
UP TO 4'-6"	L2 1/2 x 2 1/2 x 1/2
4'-6" TO 6'-6"	L3 1/2 x 3 1/2 - LLV
6'-7" TO 8'-0"	L4 x 3 1/2 x 1/2 - LLV

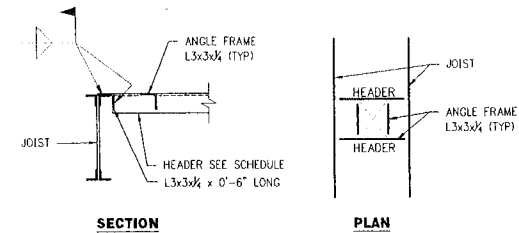

SECTION
PLAN
NOTES
VERIFY EXACT NUMBER, SIZE & LOCATION OF OPENINGS
W/ ARCHITECTURAL & MECHANICAL.

STEEL JOIST FRAMING



HUGHES
ARCHITECTURAL
DESIGNS

1202 N STATE LINE AVE
SUITE #102
TEXARKANA, AR 71854
501-627-2446
michal@hughes72477@gmail.com

New Storm Shelter Facility for:
Arkansas Christian Academy
Bryant, Arkansas

Revisions:

Professional stamp:
STATE OF ARKANSAS
REGISTERED PROFESSIONAL ENGINEER
No. 10449
FAIRLEY M. PLOUNDE
DATE SIGNED: 12-04-2023
FOR 3rd PARTY REVIEW
NOT FOR CONSTRUCTION

Sheet Title
Typical Details

Date:
Sheet Number:

S2.3



LIVE OAK
ENGINEERING
2509 7TH AVENUE SOUTH
BIRMINGHAM, AL 35233
205.637.3115
LOE# 256-1



HUGHES
ARCHITECTURAL
DESIGNS

1202 N STATE LINE AVE
SUITE #102
TEXARKANA, AR 71854
501-627-2448
micha@hughes7277@gmail.com

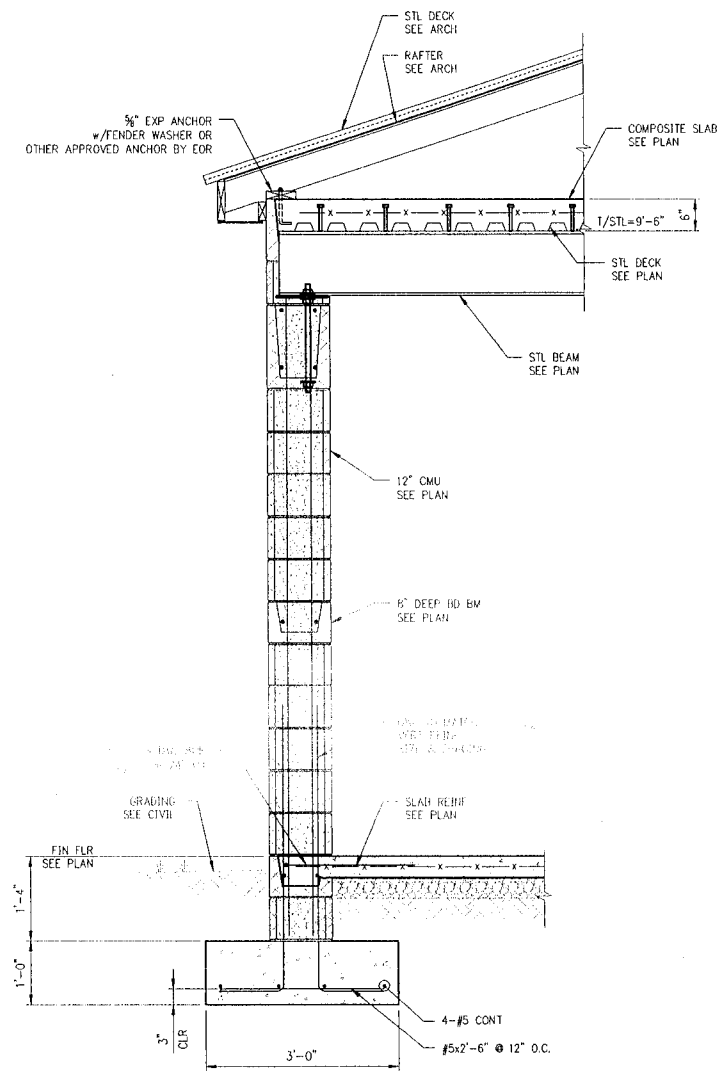

1 SECTION
S3.1 3/4"=1'-0"

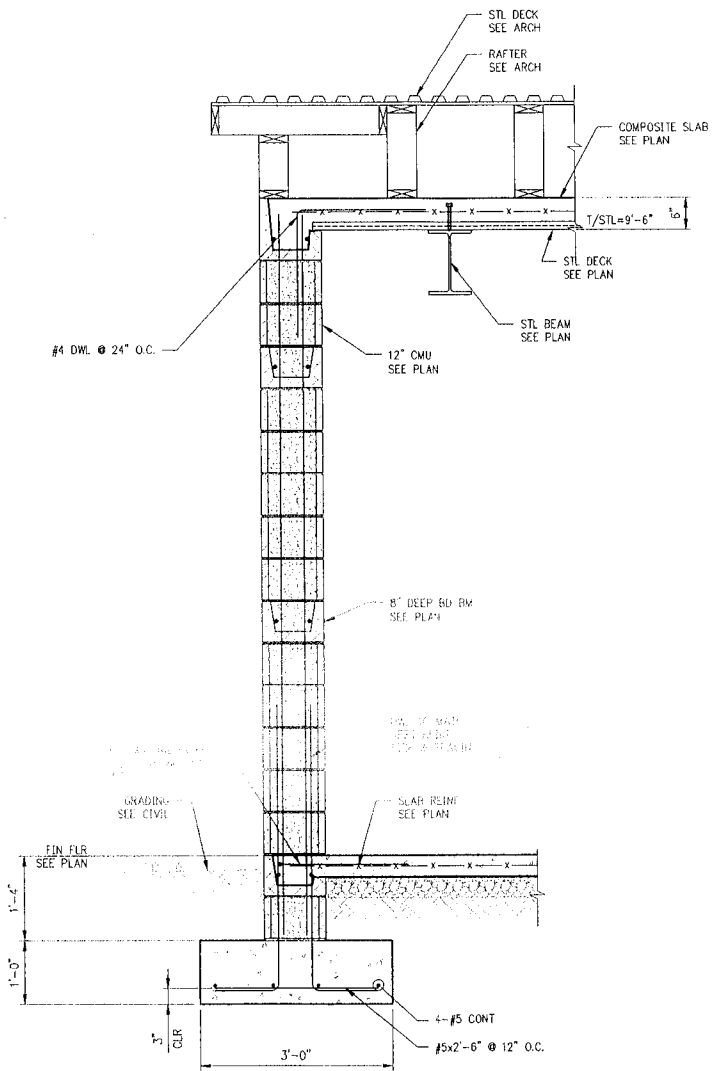

2 SECTION
S3.1 3/4"=1'-0"

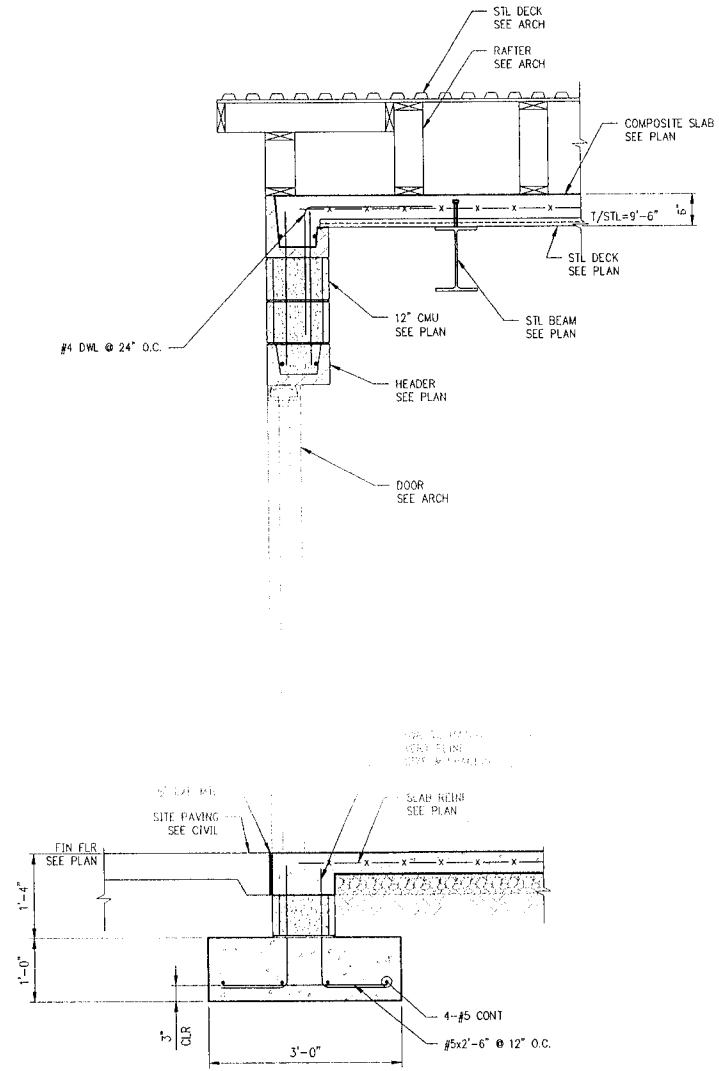

3 SECTION
S3.1 3/4"=1'-0"

New Storm Shelter Facility for:
Arkansas Christian Academy
Bryant, Arkansas

Revisions:

Professional stamp:
STATE OF
ARKANSAS
REGISTERED
PROFESSIONAL
ENGINEER
No. 10449
PATRICK M. PLOURDE
DATE SIGNED:
12-04-2023
FOR 3rd PARTY REVIEW
NOT FOR CONSTRUCTION

Sheet Title:
Framing
Sections

Date:
Sheet Number:

S3.1



**LIVE OAK
ENGINEERING**
2509 7TH AVENUE SOUTH
BIRMINGHAM, AL 35233
205-637-5115
LOE# 258-1

PROJECT INFO: sharks

RENDERING: channel letters

AERO SIGNS
3308 pike ave
N. Little Rock, AR 72118
501.246.4952

PROJECT MANAGER Mike V

SITE ADDRESS 5309-5313 Highway 5 N bryant AR

CONTACT PERSON

DESIGNER M, Vazquez

DATE: 12 / 14 / 2023



SPECIFICATION & MATERIALS

DETAIL DESCRIPTION

Side view

channel letters led lit:

- Color Painted First Surface
- .040" Alum. Returns And
- .060" acrylic Faces

38.6 SQ ft

- white L.E.D. Illumination
- 120v Mod-60 Power Supplies
- Aluminum Frame

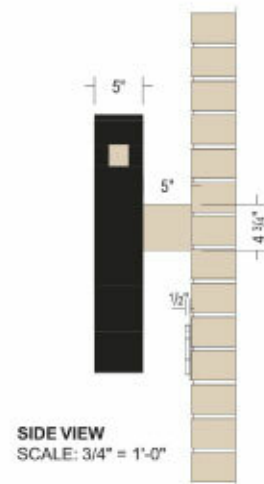

SIDE VIEW
SCALE: 3/4" = 1'-0"